

OCTOBER · 1950

electronics

A MCGRAW-HILL PUBLICATION

MICROWAVE OMNI-RANGE LENS



Give

enough!



ULTRA COMPACT UNITS...OUNCER UNITS

HIGH FIDELITY SMALL SIZE FROM STOCK

UTC Ultra compact audio units are small and light in weight, ideally suited to remote amplifier and similar compact equipment. High fidelity is obtainable in all individual units, the frequency response being ± 2 DB from 30 to 20,000 cycles.

True hum balancing coil structure combined with a high conductivity die cast outer case, effects good inductive shielding.

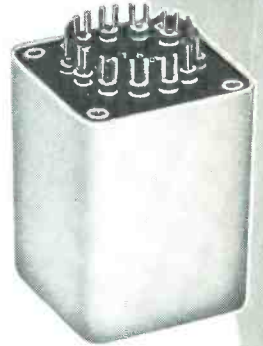

TYPE A CASE
1 1/2" x 1 1/2" x 2" high

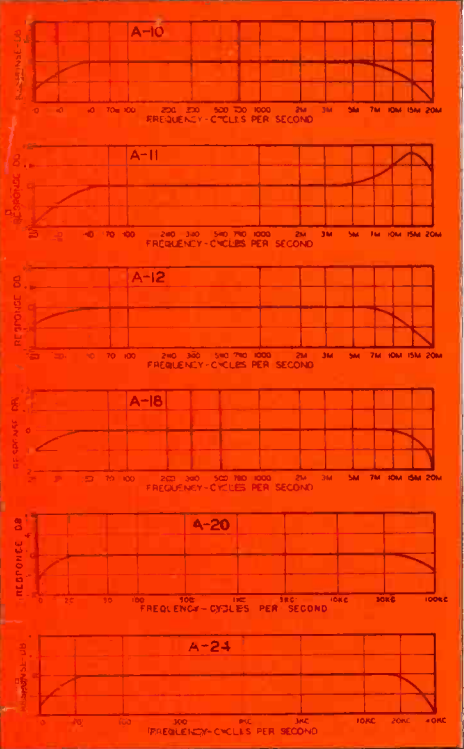

Type No.	Application	Primary Impedance	Secondary Impedance	List Price
A-10	Low impedance mike, pickup, or multiple line to grid	50, 125/150, 200/250, 333, 500/600 ohms	50,000 ohms	\$15.00
A-11	Low impedance mike, pickup, or line to 1 or 2 grids (multiple alloy shields for low hum pickup)	50, 200, 500	50,000 ohms	16.00
A-12	Low impedance mike, pickup, or multiple line to grids	50, 125/150, 200/250, 333, 500/600 ohms	80,000 ohms overall, in two sections	15.00
A-14	Dynamic microphone to one or two grids	30 ohms	50,000 ohms overall, in two sections	14.00
A-20	Mixing, mike, pickup, or multiple line to line	50, 125/150, 200/250, 333, 500/600 ohms	50, 125/150, 200/250, 333, 500/600 ohms	15.00
A-21	Mixing, low impedance mike, pickup, or line to line (multiple alloy shields for low hum pickup)	50, 200/250, 500/600	50, 200/250, 500/600	16.00
A-16	Single plate to single grid	15,000 ohms	60,000 ohms, 2:1 ratio	13.00
A-17	Single plate to single grid 8 MA unbalanced D.C.	As above	As above	15.00
A-18	Single plate to two grids. Split primary	15,000 ohms	80,000 ohms overall, 2.3:1 turn ratio	14.00
A-19	Single plate to two grids 8 MA unbalanced D.C.	15,000 ohms	80,000 ohms overall, 2.3:1 turn ratio	18.00
A-24	Single plate to multiple line	15,000 ohms	50, 125/150, 200/250, 333, 500/600 ohms	15.00
A-25	Single plate to multiple line 8 MA unbalanced D.C.	15,000 ohms	50, 125/150, 200/250, 333, 500/600 ohms	14.00
A-26	Push pull low level plates to multiple line	30,000 ohms plate to plate	50, 125/150, 200/250, 333, 500/600 ohms	15.00
A-27	Crystal microphone to multiple line	100,000 ohms	50, 125/150, 200/250, 333, 500/600 ohms	15.00
A-30	Audio choke, 250 henrys @ 5 MA 6000 ohms D.C., 65 henrys @ 10 MA 1500 ohms D.C.			10.00
A-32	Filter choke 60 henrys @ 15 MA 2000 ohms D.C., 15 henrys @ 30 MA 500 ohms D.C.			9.00

UTC OUNCER components represent the acme in compact quality transformers. These units, which weigh one ounce, are fully impregnated and sealed in a drawn aluminum housing 7/8" diameter... mounting opposite terminal board. High fidelity characteristics are provided, uniform from 40 to 15,000 cycles, except for O-14, O-15, and units carrying DC which are intended for voice frequencies from 150 to 4,000 cycles. Maximum level 0 DB.



OUNCER CASE

7/8" Dia. x 1 1/8" high

Type No.	Application	Pri. Imp.	Sec. Imp.	List Price
O-1	Mike, pickup or line to 1 grid	50, 200/250 500/600	50,000	\$13.25
O-2	Mike, pickup or line to 2 grids	50, 200/250 500/600	50,000	13.25
O-3	Dynamic mike to 1 grid	7.5/30	50,000	12.00
O-4	Single plate to 1 grid	15,000	60,000	10.50
O-5	Plate to grid, D.C. in Pri.	15,000	60,000	10.50
O-6	Single plate to 2 grids	15,000	95,000	12.00
O-7	Plate to 2 grids, D.C. in Pri.	15,000	95,000	12.00
O-8	Single plate to line	15,000	50, 200/250, 500/600	13.25
O-9	Plate to line, D.C. in Pri.	15,000	50, 200/250, 500/600	13.25
O-10	Push pull plates to line	30,000 ohms plate to plate	50, 200/250, 500/600	13.25
O-11	Crystal mike to line	50,000	50, 200/250, 500/600	13.25
O-12	Mixing and matching	50, 200/250	50, 200/250, 500/600	12.00
O-13	Reactor, 300 Hys.—no D.C.; 50 Hys.—3 MA. D.C.,	6000 ohms		9.50
O-14	50:1 mike or line to grid	200	1/2 megohm	13.25
O-15	10:1 single plate to grid	15,000	1 megohm	13.25

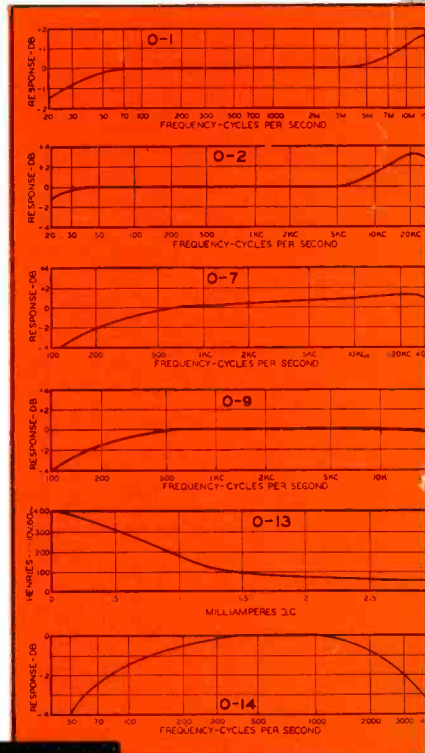

United Transformer Co.

150 VARICK STREET • NEW YORK 13, N. Y.

EXPORT DIVISION: 13 EAST 40th STREET, NEW YORK 16, N. Y., CABLES: 'ARLAB'

electronics



A MCGRAW - HILL
PUBLICATION

OCTOBER • 1950

MICROWAVE OMNIRANGE LENS	COVER
New Sperry 5,000-mc omnirange antenna lens eliminates ground reflections (see p 118)	
NEW IDEAS IN TELEVISION STUDIO DESIGN , by N. F. Smith.....	66
Separation of programming and technical control increases flexibility	
SUN FOLLOWER FOR V-2 ROCKETS , by Harry L. Clark.....	71
Phototube-controlled servo-drive motors track sun in upper-atmosphere research	
ELECTRONIC INSPECTION OF ENGINE CAM CONTOURS , by M. G. Turkish.....	74
Voltage proportional to valve stem velocity is produced on cathode-ray screen to reveal contour errors	
CURTAIN-ROD F-M ANTENNA FOR BUSES , by Louis E. Raburn.....	78
Body forms part of tunable horizontal loop exhibiting nearly omnidirectional characteristics	
GETTER MATERIALS FOR ELECTRON TUBES , by W. Espe, M. Knoll, M. Wilder.....	80
Complete summary of all materials used to remove gas in electron tubes without extensive pumping	
AIRCRAFT IGNITION TESTER , by W. M. Bauer and L. G. Sands.....	87
Ignition system can be tested on ground under simulated flight conditions	
VIDEO PROGRAM RECORDING , by F. Gillette, G. King and R. White.....	90
Electronic circuits substitute for movie camera mechanisms to provide independence of synchronizing frequency	
PRODUCTION TESTER FOR TRANSISTORS , by L. P. Hunter and R. E. Brown.....	96
A-C tester gives transistor characteristics quickly and conveniently	
SELECTIVE MIXING AMPLIFIER FOR AIRCRAFT , by Paul B. King.....	100
Permits pilot and copilot to select communication and navigation facilities	
PRECISION PHASEMETER FOR AUDIO FREQUENCIES , by J. Fritz.....	102
Phase-comparison instrument attains one-tenth degree accuracy at audio frequencies	
A FAST SWEEP CIRCUIT , by N. L. Davis and R. E. White.....	107
Oscilloscope sweep speed of 100 inches per μ sec is obtained from thyatron	
CALCULATING UHF FIELD INTENSITIES , by Frederick W. Smith.....	110
Prediction of television propagation for 470 to 890 mc including nulls and maxima	
CATHODE FOLLOWER VIDEO RESPONSE , (Reference Sheet), by R. H. Baer.....	114
Chart gives ratio of permissible pulse drive to low-frequency sine-wave input	
BUSINESS BRIEFS	60
CROSSTALK	65
TUBES AT WORK	116
ELECTRON ART	120
NEW PRODUCTS	124
NEWS OF THE INDUSTRY	128
NEW BOOKS	132
BACKTALK	132
INDEX TO ADVERTISERS	(Last Page)

DONALD G. FINK, Editor; **W. W. MacDONALD**, Managing Editor; John Markus, Vin Zeluff, A. A. McKenzie, Associate Editors; William P. O'Brien, James D. Fahnestock, Assistant Editors; John M. Carroll (on Military Leave), Ann Mastropolo, Marilyn Wood, Editorial Assistants; Gladys T. Montgomery, Washington Editor; Harry Phillips, Art Director; Eleanor Luke, Art Assistant

KEITH HENNEY, Consulting Editor

H. W. MATEER, Publisher; **WALLACE B. BLOOD**, Manager; R. S. Quint, Buyers' Guide Manager; D. H. Miller, James Girdwood, New York; Wm. S. Hodgkinson, New England; Warren W. Shew, Philadelphia; C. D. Wardner, Chicago; J. L. Phillips, Cleveland; J. W. Otterson, San Francisco; Carl W. Dysinger, Los Angeles; Ralph C. Maultsby, Atlanta; Bernard H. Butler, London, England



Contents Copyright 1950, by McGraw-Hill Publishing Company, Inc. All Rights Reserved. MCGRAW-HILL PUBLISHING COMPANY, INCORPORATED. JAMES H. MCGRAW (1860-1948), Founder • PUBLICATION OFFICE, 99-129 North Broadway, Albany 1, N. Y., U. S. A. EDITORIAL AND EXECUTIVE OFFICES, 330 West 42nd St., New York 18, N. Y., U. S. A.



Curtis W. McGraw, President; Willard T. Chevallier, Executive Vice-President; Joseph A. Gerardi, Vice-President and Treasurer; John J. Cooke, Secretary; Paul Montgomery, Senior Vice-President, Publications Division; Ralph B. Smith, Editorial Director; Nelson Bond, Vice-President and Director of Advertising; J. E. Blackburn, Jr., Vice-President and Director of Circulation; Dexter Keezer, Director of Economics Department; Russell F. Anderson, Editor, World News.
ELECTRONICS: October, 1950; Vol. 23; No. 10. Published monthly with an additional issue in June, price 75¢ a copy for U. S. and possessions, and Canada; \$1.50 for other countries. Canada \$2.00 for all other foreign countries. Buyers' Guide \$2.00. Allow at least ten days for change of address. All communications about subscriptions should be addressed to the Director of Circulation. Subscription rates—United States and possessions, \$6.00 a year, \$9.00 for two years, \$12.00 for three years. Canada (Canadian funds accepted), \$10.00 a year, \$16.00 for two years, \$20.00 for three years. Latin American countries \$15.00 for one year, \$25.00 for two years, \$30.00 for three years. All other countries \$20.00 for one year, \$30.00 for two years, \$40.00 for three years. Please indicate position and company connection on all subscription orders. Entered as Second Class matter August 29, 1936, at Post Office, Albany, New York, under the act of March 3, 1879. BRANCH OFFICES: 520 North Michigan Avenue, Chicago 11, Ill.; 68 Post Street, San Francisco 4; Aldwych House, Aldwych, London, W.C. 2; Washington, D. C. 4; Philadelphia 3; Cleveland 15; Detroit 26; St. Louis 8; Boston 16; Atlanta 3, Ga.; 1111 Wilshire Blvd., Los Angeles 17; 738-9 Oliver Building, Pittsburgh 22. ELECTRONICS is indexed regularly in The Engineering Index.

MARION . . . helps the OXY-CATALYST Mfg. Co.

MAKE EXHAUST GASES
NON-POISONOUS

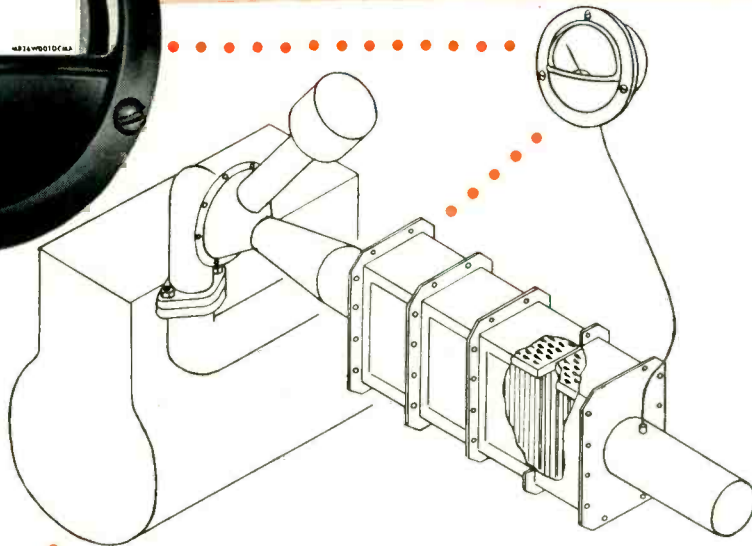

OCM manufactures a new type of Catalytic Exhaust which takes the place of the standard muffler . . . makes the exhaust gases of gasoline engines both non-poisonous and odorless. When applied to Fork Lift Trucks, for example, it makes them safe for inside use.

In developing the OCM Exhaust, a special type of ruggedized pyrometer was needed to withstand the deteriorating abuse to which OCM equipped machines are subjected. Critical accuracy, and exceptional dependability under extreme conditions of shock and vibration were necessary. Only Marion's new line of *ruggedized* instruments could meet these requirements.

This is why every OCM Exhaust now carries a Marion-made, thermocouple-operated pyrometer on the instrument panel. It indicates the temperature of the exhaust gases; tells when the unit is operating within the safe range. It also measures the air-fuel ratio while idling and so keeps a constant check on engine efficiency.

When you seek meters for unusual or standard applications, it will pay you to investigate Marion. Point for point, Marion invites comparison. Ask for catalog. There is no obligation. Marion Electrical Instrument Company, 401 Canal Street, Manchester, New Hampshire.

Canadian Representative: Astral Electric Company, 44 Danforth Road, Toronto, Ontario, Canada

Export Division: 458 Broadway, New York 13, U.S.A., Cables MORHANEX



marion meters

IT'S AS EASY AS THIS —



**TO
BUY MUIRHEAD**

OUR plant may be 3,000, 4,000 or even 5,000 miles away, but you can reach us in 24 hours, and usually we can ship immediately. You'll need our catalog of course, and our quarterly journal "Technique" tells you about new developments and applications, so you'd better have that.

**MAIL
THIS COUPON
NOW**

TO MUIRHEAD & Co. LTD. · BECKENHAM · KENT · ENGLAND

Please send me your catalog and quarterly journal "TECHNIQUE"

NAME

POSITION

COMPANY

ADDRESS

ORDER BY CABLE — PAY BY YOUR OWN DOLLAR CHECK

MUIRHEAD & Co. LTD.
PRECISION ELECTRICAL INSTRUMENT MAKERS
BECKENHAM · KENT · ENGLAND

Telegrams and Cables: MUIRHEADS ELMERS-END

PRECISION
MUIRHEAD
ELECTRICAL INSTRUMENTS

M.U.13

Exploration

for
resistors
too!

*S*pecialization in resistors lets IRC concentrate on research and quality control to a greater degree than any other supplier.

Result:—IRC exploration anticipates future resistor needs—improves existing products—and controls quality and uniformity in every IRC unit. Largest resistor manufacturer in the world, IRC attracts the finest of engineering talent. We're using more of such talent than ever, now, to keep step with today's electronic requirements—while we plan for tomorrow's advances.

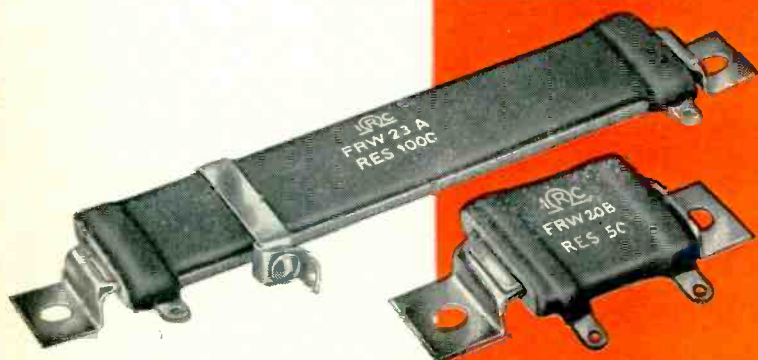

FLAT POWER WIRE WOUND RESISTORS

For high-wattage dissipation in limited-space applications, IRC Type FRW Flat Wire Wound Resistors have higher space-power ratios than standard tubular units. FRW's can be mounted vertically or horizontally—singly or in stacks. Non-magnetic mounting brackets permit easy, economical mounting, aid in heat distribution along the entire length, and transfer internal heat to the chassis. Available in 9 sizes—fixed and adjustable. Send for full details in Bulletin C-1.

is important



HIGH OHMIC RESISTORS

Engineered for high voltage applications where high resistance and power are required, IRC Type MVX Resistors are particularly suited to many types of television and electronic circuits. Unique application of IRC's proven filament resistance coating in helical turns on a ceramic tube provides a conducting path of long, effective length. Result: A unit of high resistance value with resistance materials having relatively low specific resistance. Type MVX's have 2 watt rating, are exceptionally stable—permit the use of high voltage on the resistor while keeping voltage per unit length of path comparatively low. Send coupon for complete details in Bulletin G-2.

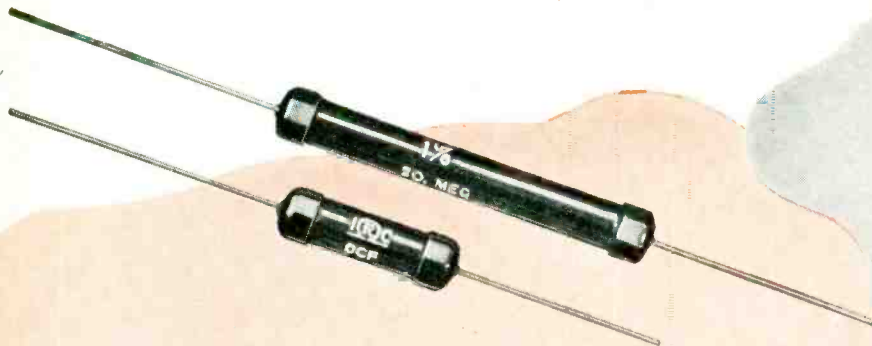

DEPOSITED CARBON PRECISTORS

A unique combination of accuracy, stability and economy makes IRC Deposited Carbon PRECISTORS ideal for applications where carbon compositions are unsuitable or wire-wound precisions too expensive. Instrumentation, advanced electronics and critical television circuits also benefit from their wide range of values, low voltage coefficient, excellent frequency characteristics, predictable temperature characteristics, high voltage rating, low noise level and small size. Coupon brings full particulars in Bulletin B-4.



VOLTMETER MULTIPLIERS Sealed-precision IRC Type MF Resistors are completely impervious to moisture—have proved themselves dependable voltmeter multipliers for use under the most severe humidity conditions. Each multiplier consists of a number of IRC Precision Resistors, mounted, interconnected, and encased in a glazed, hermetically sealed ceramic tube. MF's are compact, rugged, stable, easy to install, and may be used with very little drain on the power supply. Individual precision resistors may be either inductive or noninductive, so that they may be used on AC as well as DC. Mail coupon for full data in Bulletin D-2.



Wherever the Circuit Says

Power Resistors • Voltmeter Multipliers
 • Insulated Composition Resistors • Low
 Wattage Wire Wounds • Volume
 Controls • Voltage Dividers • Precision
 Wire Wounds • Deposited Carbon
 Precistors • Ultra-HF and High
 Voltage Resistors • Insulated Chokes

**INTERNATIONAL
 RESISTANCE COMPANY**

401 N. Broad Street, Philadelphia 8, Pa.

In Canada: International Resistance Co., Ltd., Toronto, Licensee

INTERNATIONAL RESISTANCE CO.
 403 N. BROAD ST., PHILADELPHIA 8, PA.

Please send me complete information on the items checked below:—

- | | |
|--|--|
| <input type="checkbox"/> Flat Wire Wound Resistors (C-1) | <input type="checkbox"/> Deposited Carbon PRECISTORS (B-4) |
| <input type="checkbox"/> High Voltage Resistors (G-2) | <input type="checkbox"/> Voltmeter Multipliers (D-2) |
| <input type="checkbox"/> Name and address of local IRC Distributor | |

NAME

TITLE

COMPANY

ADDRESS

CITY ZONE STATE

WORLD WIDE STANDARD OF *Constant Voltage*



SOLA Constant Voltage Transformers are manufactured and employed throughout the world for automatic, instantaneous regulation of voltage. They do not have moving parts, or require manual adjustments.



ENGLAND

Advance Components Ltd.
Walthamstow, E., England



FRANCE

M. C. B. & Veritable Alter
Courbevoie (Seine), France



ARGENTINA

Ucoa Radio S. A.
Buenos Aires, Argentina



AUSTRALIA

Endurance Electric Company
Concord West, N. S. W., Australia

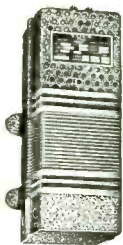

Type CV—Standard:

Wide range of capacities and voltages . . . regulation $\pm 1\%$ or less with a total primary variation of 30% . . . for electronic equipment requiring close regulation.

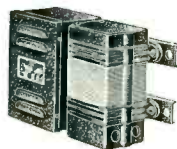

Type CVH—With Harmonic Filter:

Incorporates harmonic neutralizer circuit . . . $\pm 1\%$ regulated voltage . . . less than 3% harmonic distortion.



Type CVE—Plate and Filament Supply:

A single, compact source of filament and plate supply voltages . . . regulated to within $\pm 3\%$ or less with line voltage variations of 100-300 volts.



Type CVA—For Television Receivers:

Voltage regulation of home TV Receivers at moderate price . . . plug-in type . . . regulation $\pm 3\%$ or less.

SOLA *Constant Voltage* TRANSFORMERS

We invite your inquiry on the application and benefits of SOLA regulators to your product. BOOKLET D CV-102 is available on request.

Transformers for: Constant Voltage • Fluorescent Lighting • Cold Cathode Lighting • Airport Lighting • Series Lighting • Luminous Tube Signs • Oil Burner Ignition • X-Ray • Power • Controls • Signal Systems • etc. • **SOLA ELECTRIC COMPANY, 4633 W. 16th Street, Chicago 50, Illinois**
Manufactured under license by: ADVANCE COMPONENTS LTD., Walthamstow, E., England • M. C. B. & VERITABLE ALTER, Courbevoie (Seine), France
ENDURANCE ELECTRIC CO., Concord West, N. S. W., Australia • UCOA RADIO S.A., Buenos Aires, Argentina

No. 8
of a
series

Another Engineer's Problem Solved*

SUBJECT: HIGH TEMPERATURE
"COMPUTER"
CAPACITORS

PROBLEM: To design 1 mfd. ca-
pacitors having high
resistance at 85° to
125°C.

SOLUTION:

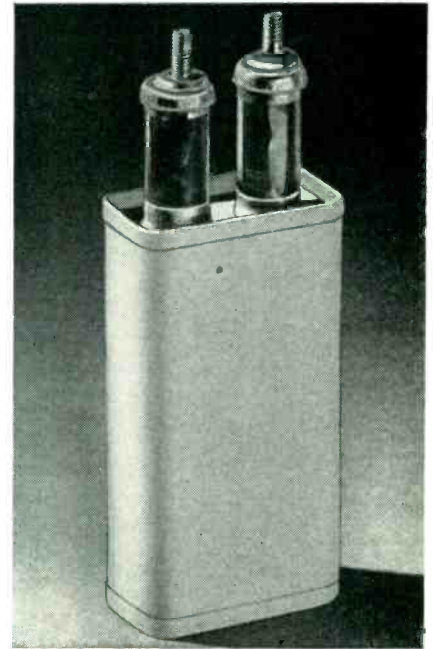

Several types of plastic film dielectrics have unusually high volume and surface resistivity at high temperatures. However, all but two of the presently available materials have relatively high dielectric absorption. Absorption sets up a residual charge which is objectionable at frequencies of 10 cycles or less.

Type P film has low dielectric absorption and very high resistance at 85°C. A Type PAC 1 mfd. capacitor in a CP 70 style can, 1 13/16 x 1 1/16 x 3" has a resistance of 200,000 megohms at 300V at 85°C. Although this capacitor can be used at 100°C, the resistance drops and the life expectancy is poor.

Using Type T film, a capacitance of only .03 mfd. can be obtained in the same can. However, at 125°C, resistance comparable to Type P at 85°C can be realized. Type TA capacitors can be operated up to 200°C.

At 85°C and higher, gasket-type terminals introduce considerable shunt-leakage. Therefore, glass-to-metal seals are used. For high humidity conditions, the glass must be treated with silicone. Even so, at 90% R.H., the maximum resistance for a metal can capacitor with a pair of glass-to-metal insulators is 5×10^{13} ohms. For this reason where smaller capacitances are required our glassmike container style is very advantageous. The type numbers are PAG and TAG.

Type PA and TA capacitors are used in servo amplifiers, integrating and differentiating circuits, electronic calculators, etc.

• • •

What is YOUR engineering problem?

Your inquiries will receive immediate attention.

• • •

We manufacture a standard line of Plasticon Capacitors,
Pulse Forming Networks and High Voltage Power Supplies.

Write for our catalog.

Condenser Products Company

1375 NORTH BRANCH STREET • CHICAGO 22, ILLINOIS

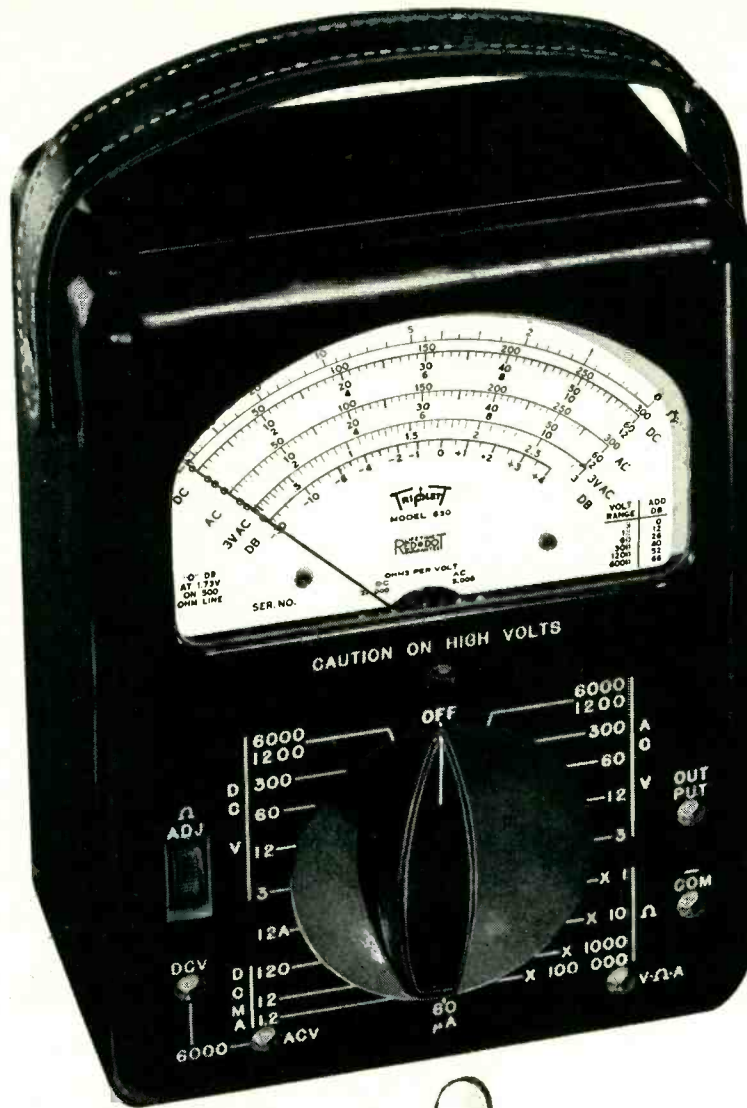

ALL RANGES WITH THIS ONE CONTROL

**Model
630**

Just *one* knob—extra large—easy to turn—flush with the panel, controls all ranges. This one knob saves your time—minimizes the chances of “burn-outs” because you don’t have to remember to set another control. You can work fast with Model 630 with your eyes as well as your hands. Look at that scale—wide open—easy to read, accurately. Yes, this is a *smooth TV* tester. Fast, safe, no projecting knobs, or jacks, or meter case. Get your hand on that single control and you’ll see why thousands of “Model 630’s” are already in use in almost every kind of electrical testing



ONLY \$39.50 AT YOUR DISTRIBUTOR

In Canada: Triplett Instruments of Canada, Georgetown, Ontario

FOR THE MAN WHO TAKES PRIDE IN HIS WORK

Triplett

TRIPLETT ELECTRICAL INSTRUMENT COMPANY · BLUFFTON, OHIO, U. S. A.

IMITATED, YES... BUT NEVER EQUALLED!

AN IMPORTANT MESSAGE TO MANUFACTURERS OF
ELECTRONIC EQUIPMENT AND THEIR ENGINEERS

ERSIN MULTICORE . . .

First solder with 3-core construction.

Only solder made with non-corrosive Ersin Flux.

Contains virgin metals only:

Tin: 99.75% pure.
Lead: 99.97% pure.

Meets all requirements of Federal Specification QQ-S-571-b, Sept. 1947.

Only major solder manufacturer whose entire production is restricted to solders of controlled, top-purity content.



NOW . . . in these hurried days of war-conversion, we stress again the importance of solder as a *component*—a working part—of your equipment. The thousands of soldered joints in your complex product are more than “just joints” . . . they are the very *nerve ends* which control performance, the collective guardian of your reputation as a manufacturer.

Ersin Multicore solder is the world's finest, and our advertisements have consistently described the little-understood standards by which to judge a solder. Through the years, we have had the satisfaction of seeing this internationally preferred product adopted by America's leading manufacturers, for exclusive use in soldering applications where the quality of the solder and its technical performance are of such importance that they are willing to pay the initially higher price in order to save production time and avoid rejects and failures.

Resulting economies in production have more than compensated for the slightly higher initial cost, so that Multicore has actually proved to be the “cheapest” of all solders. We have won acclaim for the advantages of three-core construction, for the activated, yet non-corrosive nature of Ersin Flux, and for the speed and surety of bond . . . which Multicore alone brings to your assembly line.

One by one, these characteristics have been adopted by competing brands. Today, Ersin Multicore is one of the most widely imitated

solders in the market. *Imitated, yes, but never equalled . . .* because quality and rigid manufacturing control are the main precepts which guide the production of this superior product. Constant research perpetuates this leadership.

The continuous, reliable functioning of electronic equipment in wartime assumes special significance, because the maintenance of military communications is measured in *lives*. “Little things” like high resistance joints (often directly linked to the failure of solder) may affect more than the business aspects of your contracts . . . they can affect the very timing and success of military operations.

A soldered joint costs but a fraction of a cent. Entrusted as you are with the manufacture of military communications equipment . . . *can you afford to use less than the best?*



Write for free testing sample and helpful booklet “Modern Solders”

Address U.S.A. and Canadian inquiries to
MULTICORE SALES CORPORATION
164 Duane Street • New York 13, N. Y.

Inquiries regarding other territories to
MULTICORE SOLDERS LTD.
Mellier House, Albemarle St., London W.1, Eng.

In a nutshell

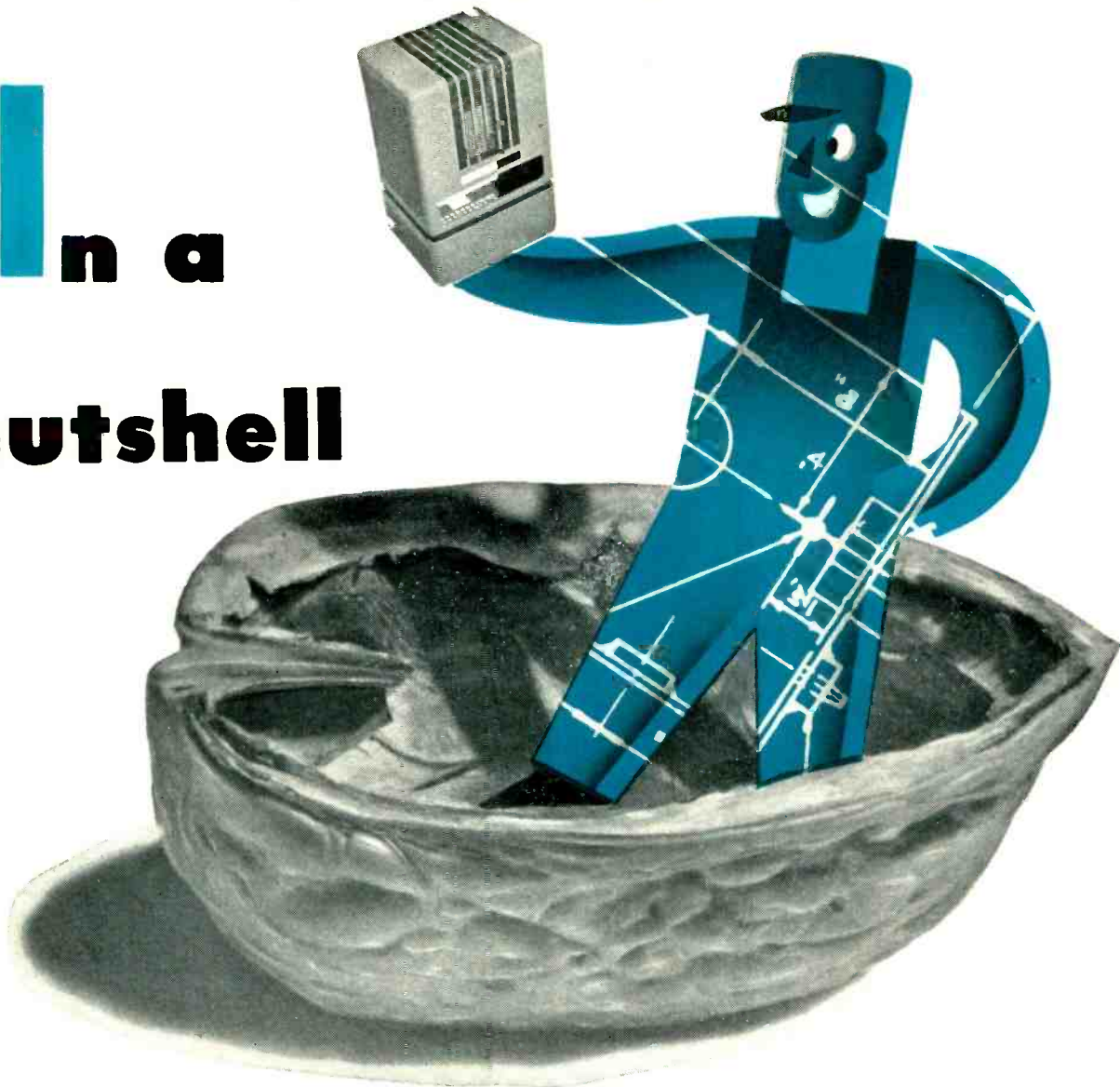

••• the Karp story is this:

We are specialists in sheet metal fabrication with over 25 years' experience in our craft.

We have some of the most ingenious men in the industry—especially in our engineering department and among our technicians.

We have 70,000 square feet of ultra-modern plant, with every up-to-date aid in the way of tools, dies and machinery.

We have the most modern painting and finishing department, which is completely dust proof, and equipped with the newest water-washed spray booths and baking ovens.

We are geared to produce—at the right cost for its specifications—anything from a simple box or chassis to the largest transmitter housing—and in any quantity.

In short, we're at your service for sheet metal fabrication at its best. And we mean service!

KARP METAL PRODUCTS CO., INC.

215-63rd STREET, BROOKLYN 20, NEW YORK

Fabricating Sheet Metal for Industry

Centralab Model 2 Radiohm

A 1951 CONTROL FOR 1951 DESIGNS

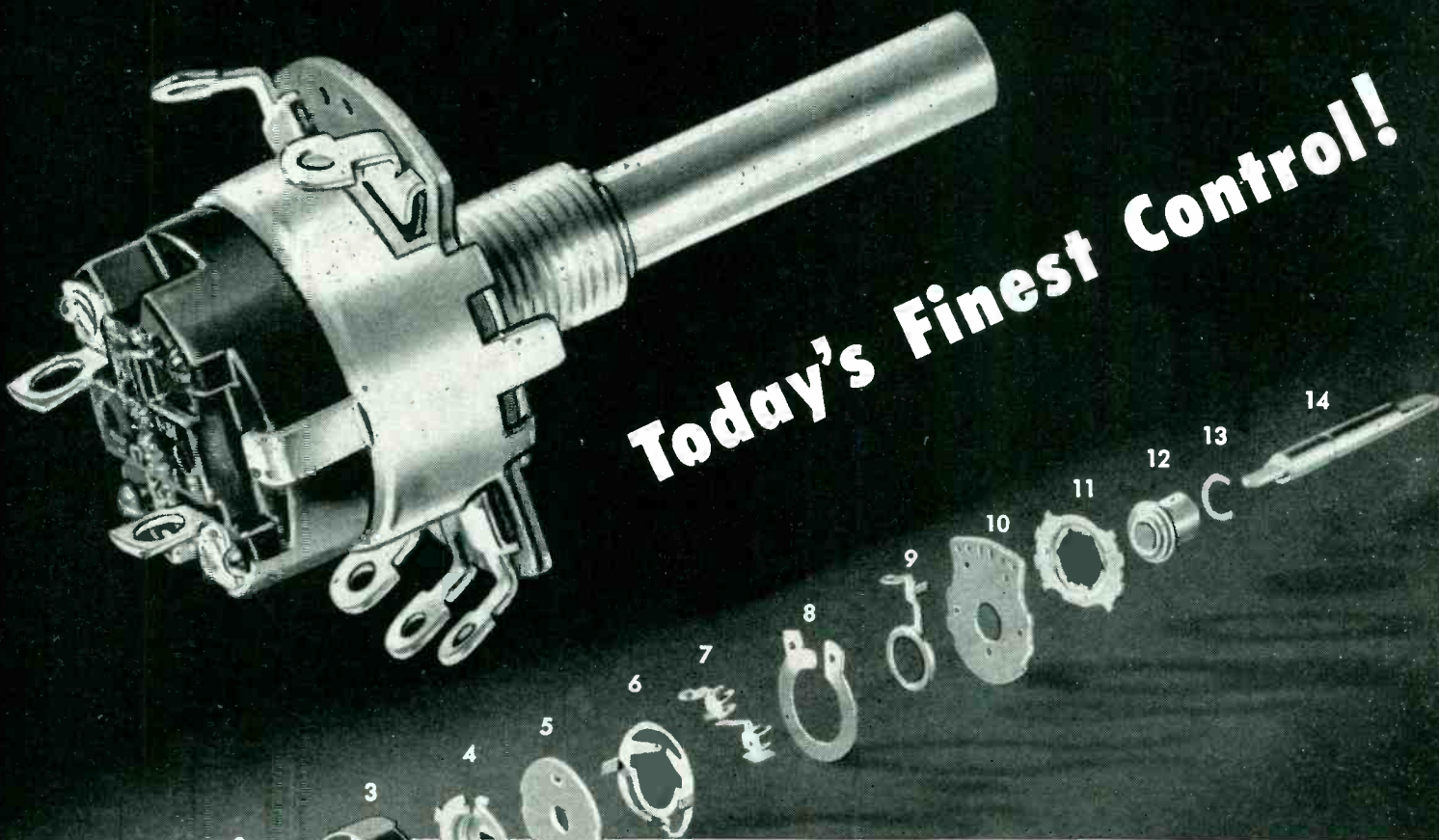

Today's Finest Control!

14 Good Reasons Why CRL'S Model 2 Radiohm is the Control for You!

1. *Switch* — with positive detent in both on and off positions. *Terminals* — with surfaces elevated to eliminate danger of shorting to cover legs . . . $\frac{1}{8}$ " hole diameter for simplified wiring . . . hot tin dipped for easy soldering . . . mechanical lock to prevent loosening in soldering operations.
2. Cadmium plated steel *cover* completely shields resistor.
3. *Insulator's* high dielectric strength permits breakdown test at 1000 volts R. M. S. Dust and dirt can't get in.
4. *Stop*, of cup design, provides superior switch shielding . . . gives you excellent torque strength without distortion.
5. High grade laminated phenolic *shoe* maintains high insulation resistance under humidity conditions.
6. Contact Spring gives you double wiping contacts on both resistor and center terminal ring . . . is accurately formed to maintain uniform pressures and minimize noise.
7. Electro tin-plated *terminals* provide soldering ease. Tightly crimped terminals give you direct contact to resistor . . . assure constant contact under humidity and soldering conditions.

8. *Resistor* is made of special resistance material bonded to high quality phenolic for smooth operation, low noise level, outstanding humidity characteristics.

9. Cadmium-tipped *center terminal* provides easy soldering . . . good shelf life without oxidation. Adequately lubricated for good rotation life, center terminal is finished to give you smooth take-off . . . minimum noise.

10. Laminated phenolic *base* maintains high insulation resistance under humidity conditions.

11. Cadmium-plated steel *ground plate* assures positive grounded cover.

12. Cadmium-plated steel *bushing* is accurately finished and fit to shaft for smooth rotation.

13. *Retaining ring*.

14. *Shaft*, Unlimited variations available to meet your specifications.

*Switch Type, Tapped. Exploded View: Switch Type, Untapped.

Centralab — DEVELOPMENTS THAT CAN HELP YOU

Division of GLOBE-UNION INC. • Milwaukee

Centralab Components AND ALL OTHER ELEC

YOU'LL FIND CENTRALAB a good source of supply for a wide range of controls, switches, ceramic capacitors, and printed Electronic Circuits in standard or custom-built models, sizes and values — for all type electronic devices — military and commercial.

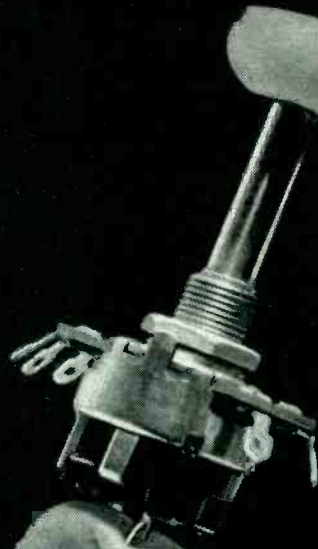

IMAGINE the large variety of uses for peak-quality controls that are only $15/16$ " in diameter, yet rated at $1/2$ watt. That's Centralab's great new line of Model 2 Radiohms. Designed for television and radio sets, sound and test equipment, the versatile Model 2 is just what you need for many other electronic uses where a combination of small size and finest performance is essential. CRL Model 2 Controls are precision built of the finest materials to give you lower noise level . . . longer life. Their clinched terminals insure rigid contact to the resistance element under humidity and soldering conditions. What's more, Model 2's complete line of 3 basic switches — 5, 8, and 1 amp. — provide 24 switch combinations for real flexibility in application and design. For all the facts, see your CRL representative or write direct.

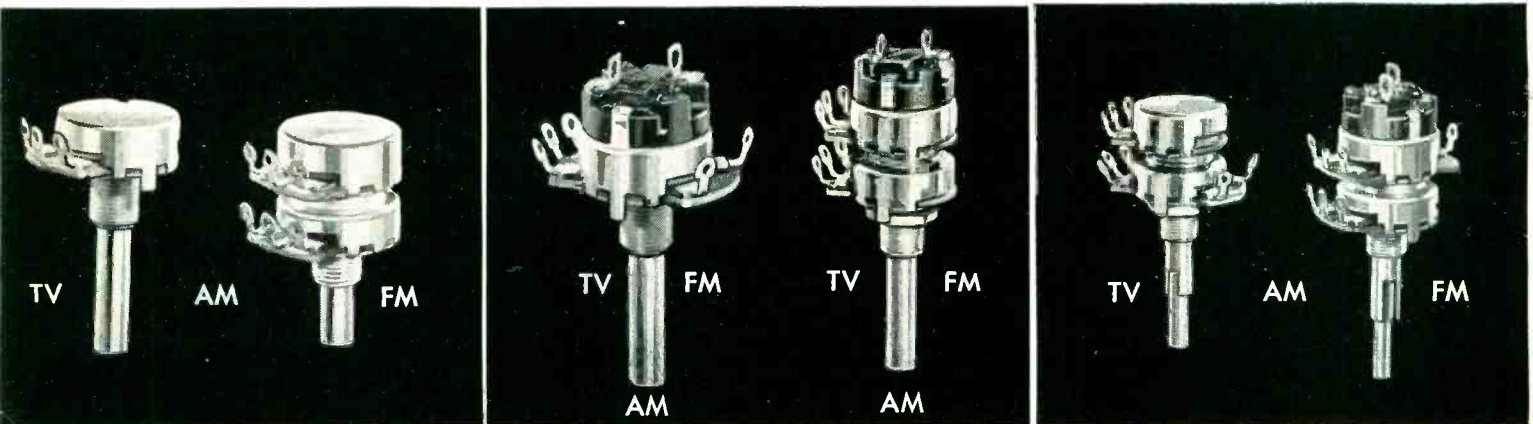

New Centralab Model 2 Radiohm Control. Left, single unit plain type, untapped; right, twin unit plain type, untapped. Both with single shafts.

New Centralab Model 2 Radiohm Controls. At left single unit switch type, tapped with single shaft. Right — twin unit switch type, untapped with single shaft.

New Centralab Model 2 Radiohm Control. Left, twin unit plain type, front section tapped; right, twin unit switch type, rear section tapped. Both units have concentric shafts.

...for TV-AM-FM TRONIC DEVICES

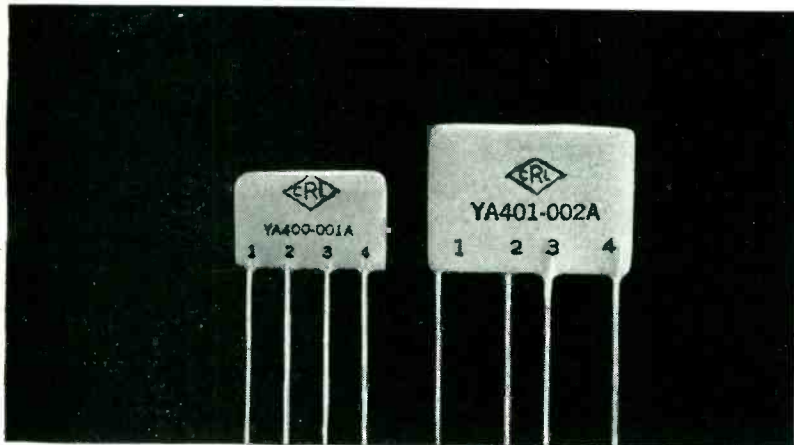

Centrallab Triode Couplates save space and weight. They actually replace 5 components normally used in audio circuits. Triode Couplates are complete assemblies of 3 capacitors and 2 resistors bonded to a dielectric ceramic plate. Available in a variety of resistor and capacitor values.

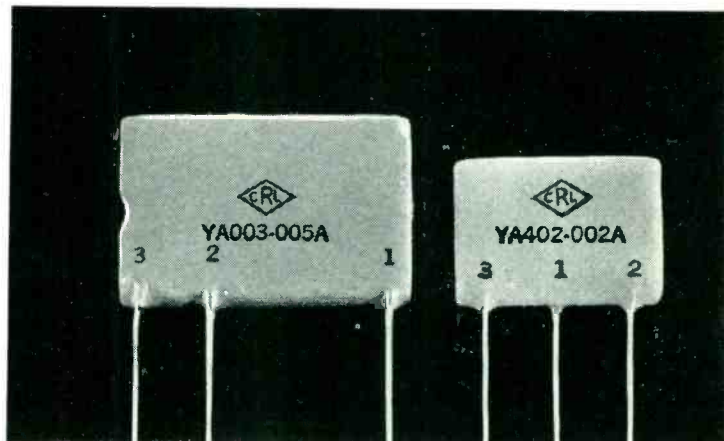

Centrallab Vertical Integrators give you big savings in assembly costs, particularly in TV vertical integrator networks. One type consists of 4 resistors and 4 capacitors brought out to 3 leads . . . reducing the formerly required 16 soldered connections to only 3! There's a big saving in the number of parts handled, too!

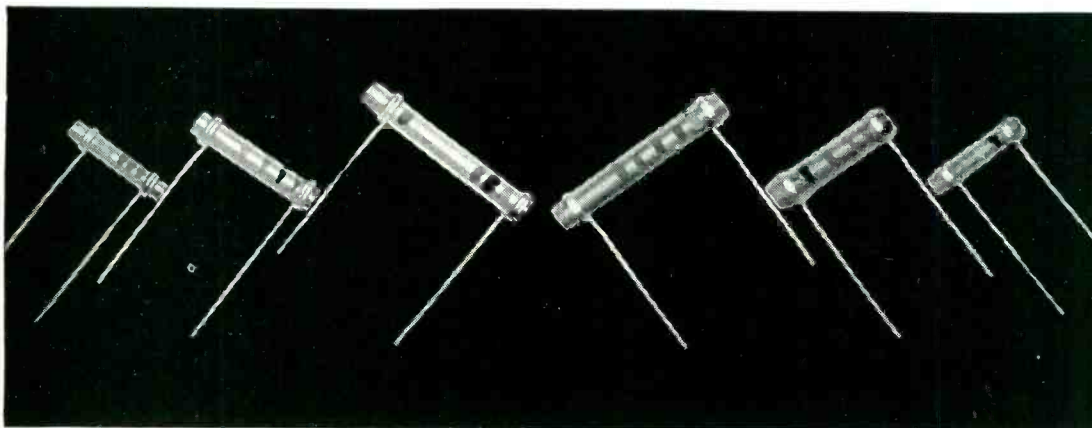

Centrallab's TC (Temperature Compensating) Tubular Hi-Kaps, left, are the most stable capacitors available. With TC Hi-Kaps, there's practically no variation due to aging or changes in temperature or humidity. For applications where temperature compensation is unimportant, use Tubular BC Hi-Kaps, right.

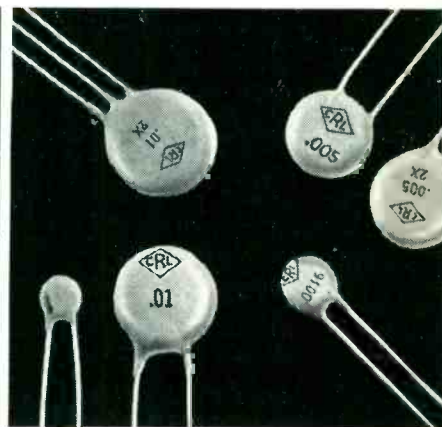

Disc: The original miniature ceramic disc capacitors combining utmost reliability with small size and low mass weight. Diameter $\frac{5}{8}$ ", $\frac{9}{16}$ ", $\frac{3}{8}$ " and $\frac{1}{4}$ ". Single shielded and non-shielded units available.

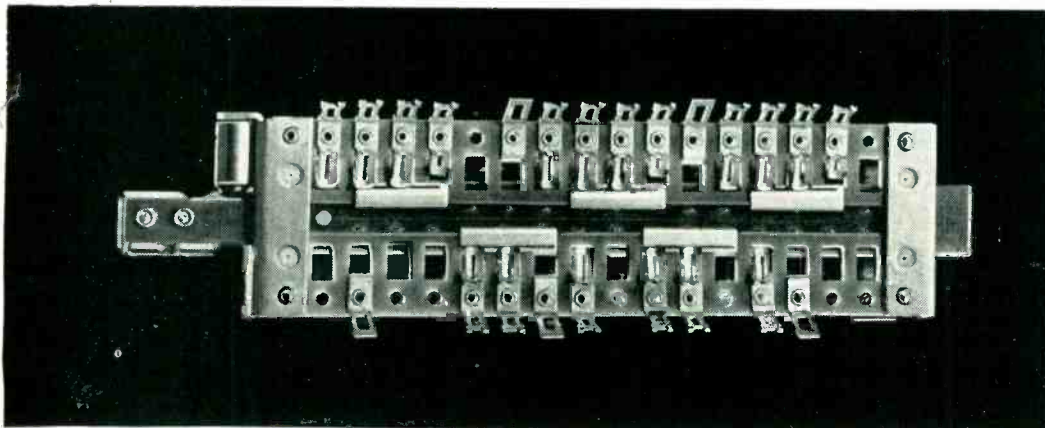

Centrallab's development of a revolutionary, new Slide Switch gives you improved AM and FM performance! Flat, horizontal design saves valuable space, allows short leads, convenient location to coils, reduced lead inductances for increased efficiency in low and high frequencies. CRL Slide Switches are rugged and dependable.

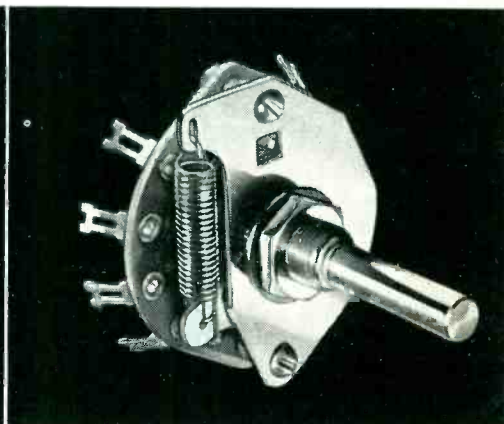

Great step forward in switching is CRL's New Rotary Coil and Cam Index Switch. Its coil spring gives you smoother action, longer life.

IMPORTANT BULLETINS FOR YOUR TECHNICAL LIBRARY!

They're factual!



THEY'RE FREE!

Choose From This List!

Centralab Printed Electronic Circuits

- 973 — AMPEC — three-tube P. E. C. amplifier.
- 42-6 — COUPLATE — P. E. C. interstage coupling plate.
- 42-22 — VERTICAL INTEGRATOR — for TV application.
- 42-24 — CERAMIC PLATE COMPONENTS — for use in low-power miniature electronic equipment.
- 42-27 — MODEL 2 COUPLATE — for small or portable set applications.
- 999 — PENTODE COUPLATE — specialized P. E. C. coupling plate.
- 42-9 — FILPEC — Printed Electronic Circuit filter.

Centralab Capacitors

- 42-3 — BC TUBULAR HI-KAPS — capacitors for use where temperature compensation is unimportant.
- 42-4R — BC DISC HI-KAPS — miniature ceramic BC capacitors.
- 42-10 — HI-VO-KAPS — high voltage capacitors for TV application.
- 42-59 — CERAMIC TUBULAR TRIMMERS — designed for TV and VHF application.
- 695 — CERAMIC TRIMMERS — CRL trimmer catalog.

- 981 — HI-VO-KAPS — capacitors for TV application. For jobbers.
- 42-18 — TC CAPACITORS — temperature compensating capacitors.
- 814 — CAPACITORS — high-voltage capacitors.
- 975 — FT HI-KAPS — feed-thru capacitors.

Centralab Switches

- 953 — SLIDE SWITCH — applies to AM and FM switching circuits.
- 970 — LEVER SWITCH — shows indexing combinations.
- 995 — ROTARY SWITCH — schematic application diagrams.
- 722 — SWITCH CATALOG — facts on CRL'S complete line of switches.

Centralab Controls

- 42-19 — MODEL "1" RADIOHM — world's smallest commercially produced control.
- 42-85 — MODEL 2 RADIOHM — CRL's new line of 1/8" diam. controls for TV — AM — FM.

Centralab Ceramics

- 967 — CERAMIC CAPACITOR DIELECTRIC MATERIALS.
- 720 — CERAMIC CATALOG — CRL steatite, ceramic products.

Look to CENTRALAB in 1950! First in component research that means lower costs for the electronic industry. If you're planning new equipment, let Centralab's sales and engineering service work with you. For complete information on all CRL products, get in touch with your Centralab Representative. Or write direct.

CENTRALAB

Division of Globe-Union Inc.
914 East Keefe Avenue, Milwaukee, Wisconsin

Yes—I would like to have the CRL bulletins, checked below, for my technical library!

- | | | | | | | |
|--------------------------------|--------------------------------|--------------------------------|--------------------------------|--------------------------------|------------------------------|--------------------------------|
| <input type="checkbox"/> 973 | <input type="checkbox"/> 42-24 | <input type="checkbox"/> 42-9 | <input type="checkbox"/> 42-10 | <input type="checkbox"/> 981 | <input type="checkbox"/> 953 | <input type="checkbox"/> 42-19 |
| <input type="checkbox"/> 42-6 | <input type="checkbox"/> 42-27 | <input type="checkbox"/> 42-3 | <input type="checkbox"/> 42-59 | <input type="checkbox"/> 42-18 | <input type="checkbox"/> 970 | <input type="checkbox"/> 42-85 |
| <input type="checkbox"/> 42-22 | <input type="checkbox"/> 999 | <input type="checkbox"/> 42-4R | <input type="checkbox"/> 695 | <input type="checkbox"/> 814 | <input type="checkbox"/> 995 | <input type="checkbox"/> 967 |
| | | | | <input type="checkbox"/> 975 | <input type="checkbox"/> 722 | <input type="checkbox"/> 720 |

Name.....

Address.....

City..... State.....

TEAR OUT COUPON

for the Bulletins you want

Centralab

Division of GLOBE-UNION INC. • Milwaukee

Here's the ideal amplifier for control applications

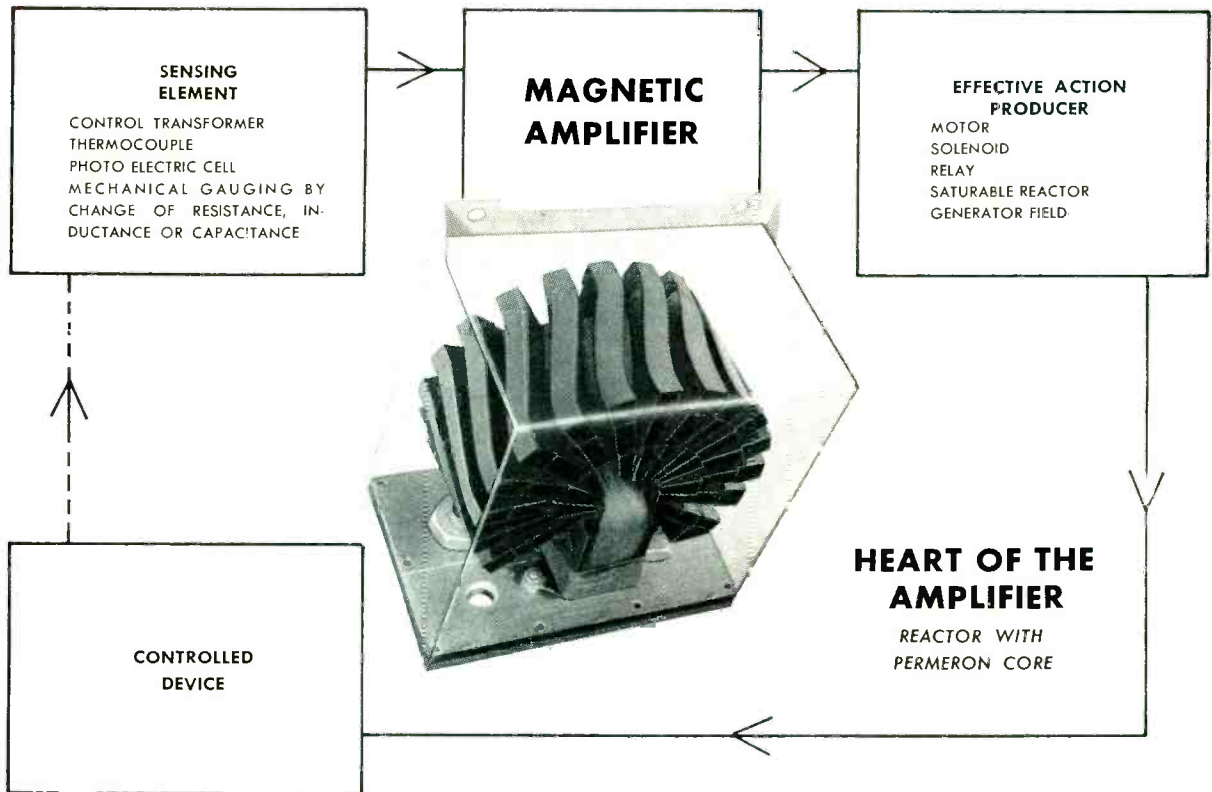

Why? Well, for one thing it's a *magnetic* amplifier. The advantages are obvious: there are no moving parts — hence, there's nothing to wear out. It's shock-proof and vibration-proof.

Secondly, it has a core of PERMERON — I-T-E's amazing new core material. We say "amazing" because *all* PERMERON cores have identical magnetization characteristics. This means designers can predict amplifier performance accurately and positively *before* undertaking the expensive job of winding and potting the reactor!

Furthermore, the lower control currents required in amplifiers made with PERMERON cores result in space-saving equipment with higher amplification factors and faster response time!

Magnetic amplifiers with PERMERON cores are now being produced by several large electrical manufacturers for an ever-expanding field of uses. These cores, with their amazing characteristics, have helped make magnetic amplifiers practical for many new uses and better for many old ones.

If *your* business is amplifiers, or controls, it will pay you to take another look at PERMERON!

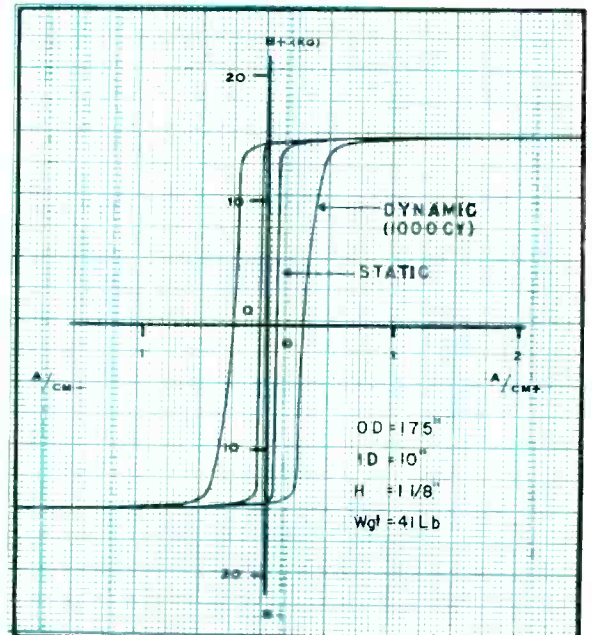

For additional information write—I-T-E Rectifier Division, or consult your local I-T-E Representative

I-T-E PERMERON

A product of Rectifier Division, I-T-E CIRCUIT BREAKER COMPANY,
19th & Hamilton Streets, Philadelphia 30, Pa.

MECHANICAL RECTIFIERS • SWITCHGEAR • UNIT SUBSTATIONS • ISOLATED PHASE BUS STRUCTURES • RESISTORS • SPECIAL PRODUCTS

to control high frequencies

USE LOW-CAPACITANCE RELAYS...

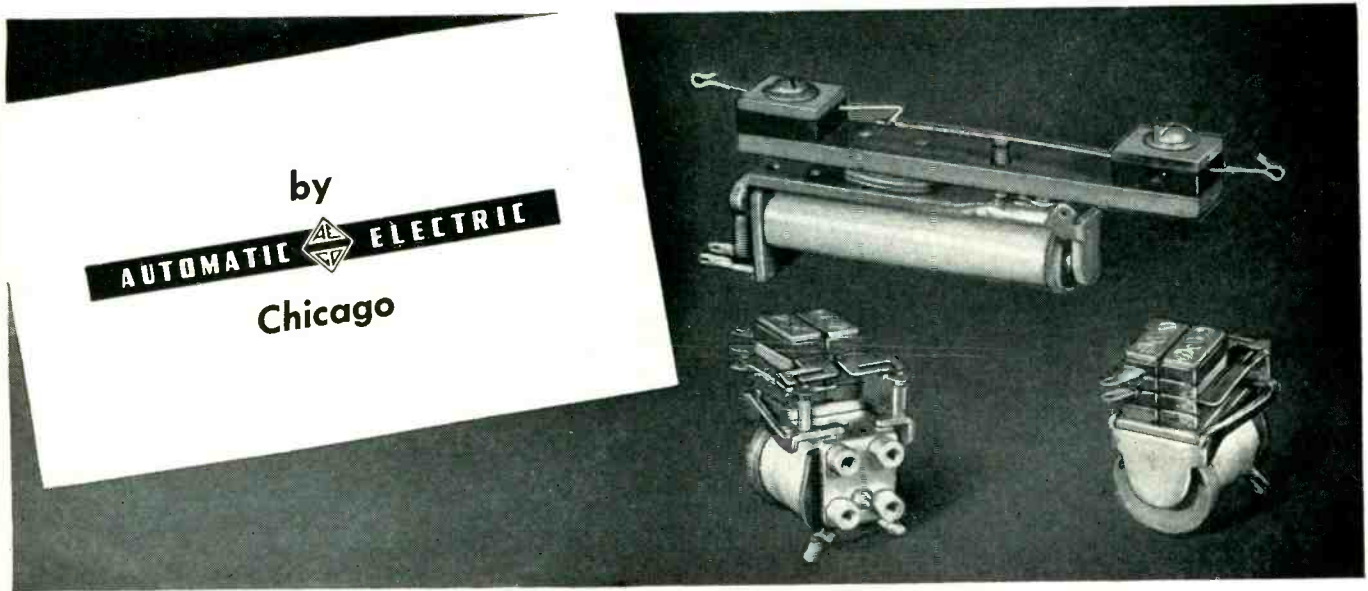

For smooth, chatter-free control of microwave circuits... switch them with Automatic Electric relays. Automatic Electric made its first low-capacitance relay more than ten years ago, and today offers two types, each providing exceptionally low capacitance between contact springs, and between springs and ground (frame, mounting, etc.)

In addition to these low-capacitance characteristics, Automatic Electric relays provide the dependability of "twin" contacts and the small size you need for compact mounting. The Class "C" relay (background above) is especially suitable for strip mounting; it is only 0.687" wide and 2 1/8" high and is 5 15/32" in over-all length. The Class "S" relay (two views in foreground) is 1" wide, 1 3/8" high and 1 19/32" long, over-all. Operating mechanisms are basically standard Automatic Electric designs, thus assuring the high operating efficiency for which Automatic Electric controls are famous.

To receive complete information, simply let us know your specific needs. Address AUTOMATIC ELECTRIC SALES CORPORATION, Chicago 7, Ill. In Canada: Automatic Electric (Canada) Ltd., Toronto. *Offices in Principal Cities.*

RELAYS

SWITCHES

AUTOMATIC ELECTRIC

CHICAGO

OTHER AUTOMATIC ELECTRIC TELEPHONE-TYPE CONTROLS



Stepping Switches



Relays



Turn Keys



Lever Keys

Efficient, dependable Automatic Electric controls are available also for many other uses. Lever, turn and push-type keys; telephone-type dials; stepping switches; lamp jacks and caps—as well as a complete range of telephone-type relays carrying the Automatic Electric name—are now in service in hundreds of industrial applications.

DUMONT

announces
four new
OSCILLOGRAPH-RECORD
cameras

...FOR more versatile SINGLE-TRANSIENT recording

The New Du Mont
Type 295



...FOR thrifty SINGLE-FRAME recording

The New Du Mont
Type 296

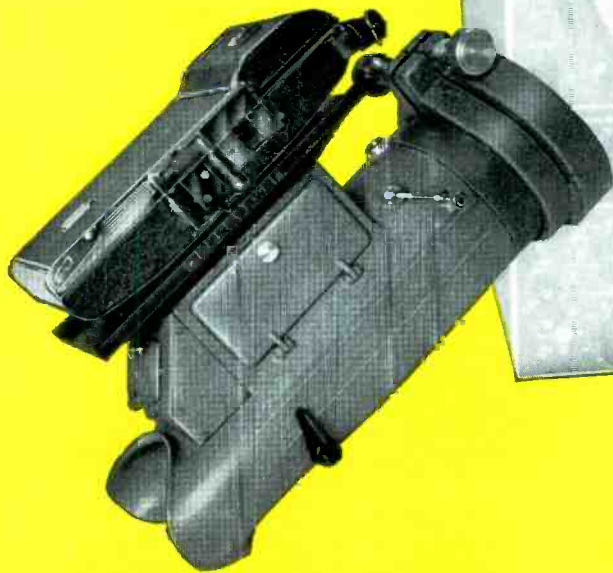

...FOR improved FINISHED-PRINT recording

The New Du Mont
Type 297

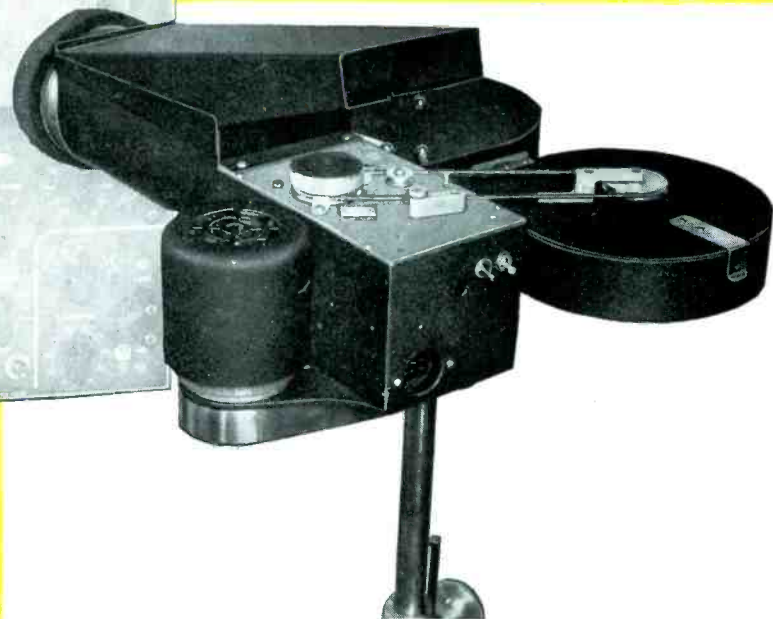

...FOR simplified MOVING-FILM recording

The New Du Mont
Type 321

NOW! more than ever it's DuMont when you RECORD TO REMEMBER

A new and complete line of oscillograph-record cameras.

The Du Mont Type 295

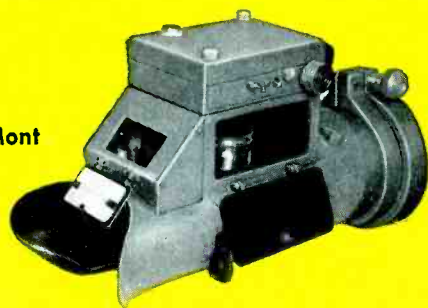

Transient phenomena representing writing rates as high as 180 inches per microsecond are recorded effectively with the Du Mont Type 295. The high-writing-rate capabilities of the Type 295 are obtained by the use of an $f/1.5$, 50mm, coated lens having excellent resolution and a minimum of rectilinear distortion. The camera accommodates plain or perforated 35mm film or paper and will make 40 exposures from a standard 36-exposure cassette. Film may be removed from the camera as it is exposed by use of a cut-off knife and a detachable, light-

tight, film take-up cassette. Thus, a portion of the film may be developed while subsequent exposures are being made. Comfortable binocular viewing is possible while recording. An illuminated data card records pertinent hand-written information directly below the exposed trace. The housing has a side-access door through which the lens aperture is accessible. The aperture control has "click" settings. Both Time and Bulb exposures may be taken. The camera may be adapted for remote control of film advance and shutter release.

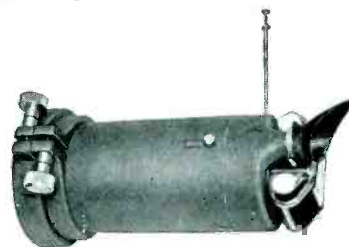

The Du Mont Type 296

Single-frame recording provided by the Type 296 represents the most versatile and inexpensive general-purpose technique. Oscillograph-record application of the Type 296 is unlimited except by the specialized needs of moving-film recording and ultra-high writing speeds. Compact in design, light in weight, and sturdy in construction, the Type 296 is easy to handle and is mounted quickly to all 5-inch cathode-ray oscillographs equipped with the Du Mont

Type 2501 Bezel. A high-quality, $f/2.8$, 41.5mm, coated lens increases the writing-rate capabilities of the Type 296 approximately 57% over the Type 271-A, which it supersedes. Shorter focal length shortens the overall length of the Type 296. A self-winding shutter has speeds of 1/200, 1/100, 1/50, 1/25, 1/10 sec., Time and Bulb. A comfortable, soft-rubber eyepiece permits simultaneous viewing and recording. The Type 296 weighs only 5 lbs.

The Du Mont Type 297



For applications where minute-to-minute comparison of waveforms is required, the Du Mont Type 297 furnishes a finished print in a minute, by the Polaroid-Land Process. The Polaroid-Land camera-back is attached to the mirror housing by means of a slide adaptor which has three snap stops making it possible to record one, two, or three traces on a single print. The camera may be set at any point along the slide so that adjustment may also be continuous where more than three traces are desired on a single print. An illuminated data card permits recording information photographically on

the print. All possible confusion between similar prints is eliminated. The camera is positioned so that the operator pulls the film toward him. Thus, the quick, smooth motion necessary to obtain clean prints is achieved with ease and comfort. The Type 297 incorporates a special, $f/2.8$ coated lens. Exposures may be taken at shutter speeds of 1/200, 1/100, 1/50, 1/25, 1/10 sec., Time, and Bulb. The recorded image is reduced to one-third the object size. The Type 297 is mountable on any 5-inch cathode-ray oscillograph and is supported completely by clamping it to the Du Mont Type 2501 Bezel.



The Du Mont Type 321

The moving-film camera makes possible the presentation of waveforms upon an unusually long time-base, and augments the performance of the cathode-ray oscillograph.

Many improvements from the standpoints of performance and operation have been incorporated in the Type 321 to simplify moving-film recording. The camera accommodates 400 feet of perforated or unperforated 35mm film or recording paper. Both the load and take-up magazines may be detached from the camera in a few seconds. Film-loading is amazingly simple — there is no threading necessary, no complicated path to follow. Film speed is variable in eighteen steps from approximately one inch per minute to 10,300 inches per minute (15 feet per second).

Full speed is attained almost instantly. Less than one inch of film is wasted in stopping the motion of the film even when the camera is operating at the highest speed. Specially designed film-braking minimizes the possibility of clogging, jamming, or breaking of the film. A film-supply indicator gives positive indication when

the recording film is exhausted.

The camera may be rotated 90 degrees, permitting either vertical or horizontal recordings to be made without rotating the cathode-ray tube or reversing deflection-plate leads. Single-frame records may also be made with the Type 321. Film travel may be time-calibrated by a flashing glow lamp. The light shield permits simultaneous viewing and recording. An illuminated data-card transfers pertinent information to the film. The Type 321 uses an $f/1.5$, 50mm, coated lens. Focus is fixed for general oscillographic applications but may be adjusted where required. Any desired length of exposed film may be removed from the camera by means of a cut-off knife. The take-up magazine may be removed quickly and carried to the darkroom. Additional magazines are relatively inexpensive. Stand mounting makes the Type 321 highly mobile. It can be mounted either

from the floor or bench top. There is no mechanical connection between the camera and the oscillograph. A sponge-rubber sleeve makes the mounting light-tight and vibration proof.

ALLEN B. DU MONT LABORATORIES, INC.
INSTRUMENT DIVISION
1000 MAIN AVE., CLIFTON, N. J.

WHAT is a *MILLIWATT?*

**-for the correct
answer from
VHF to EHF,
ask**

PRD



INDICATION:

Direct reading power measurement in four ranges of 0.1, 1, 10, and 100 milliwatts full scale is provided by the Type 650 Universal Power Bridge. This instrument may be used with positive or negative temperature coefficient bolometers operating from 50 to 250 ohms with bias currents of 3 to 40 milliamperes.

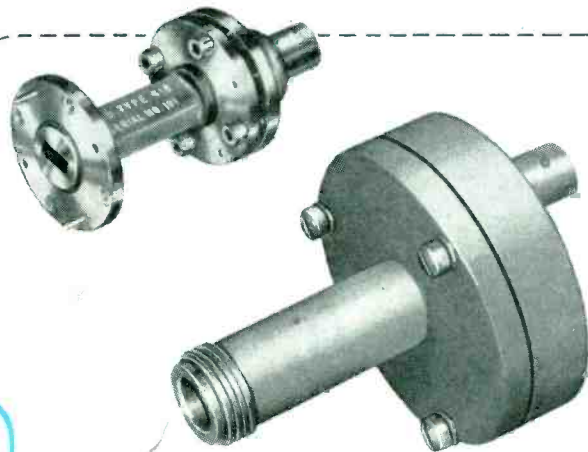

DETECTION:

PRD now offers a complete series of Broadband Coaxial Bolometer Mounts covering in three bands the range from 20 to 10,000 megacycles per second. Both 1 mw and 100 mw units are available for direct operation with the PRD Type 650 Universal Power Bridge. Additional wave-guide detectors provide coverage of the 12.4-40 kilo-megacycle band.

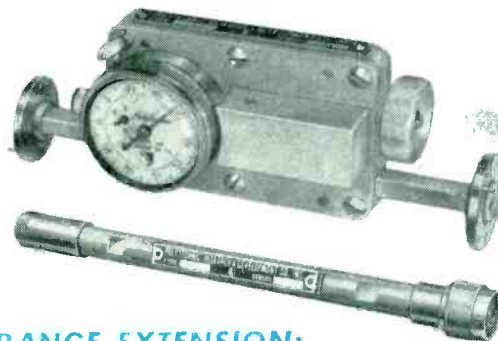

RANGE EXTENSION:

A full complement of fixed and variable attenuators permits extension of the power range of bolometer elements to higher input levels. Directional couplers are also available for this purpose.

PRD now provides the instrumentation to permit accurate power measurement over broad frequency bands with great precision and comforting ease of operation. Thus, another parameter is erased from the realm of the unknown by PRD's continuing program aimed at providing the r-f engineer with the best in test equipment. For full information concerning our complete list of products write Dept. E-9 today.



Polytechnic **RESEARCH
& DEVELOPMENT COMPANY, Inc.**

202 TILLARY ST., BROOKLYN 1, NEW YORK



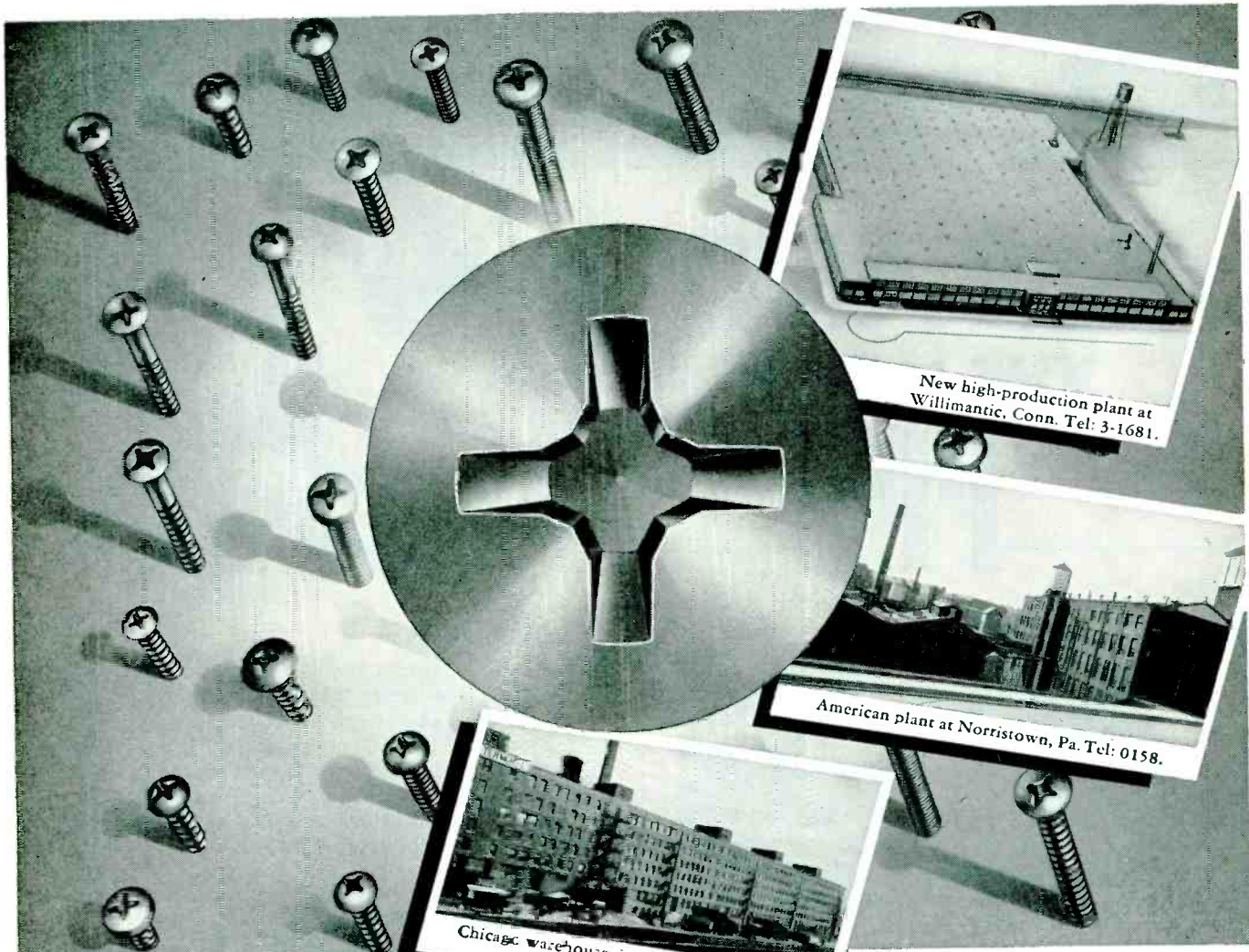

Now... more than ever... AMERICAN is PHILLIPS HEADquarters

Yes, more than ever since American developed the Phillips Recessed Head and gave it to industry, American Phillips Screws of all types and metals are rolling out in larger quantity and higher quality.

5 acres of new machines and equipment, in the modern plant at Willimantic . . . plus the Norristown plant and Chicago warehouse . . . are keeping distributors and

jobbers supplied to fill your orders *right now*. And that goes for all slotted fasteners, too.

Make a note of the *new phone number* of the new main plant . . . Willimantic, Connecticut 3-1681 . . . also Chicago—Whitehall 4-5866, and Norristown 0158. Call the number nearest you, whenever you want action on large or small orders for Phillips or slotted.

AMERICAN SCREW COMPANY

Plants at Willimantic, Conn., and Norristown, Pa.
Warehouses at: Chicago 11: 585 E. Illinois St. Detroit 2: 502 Stephenson Bldg.

AMERICAN

Phillips SCREWS Slotted

4-WINGED DRIVER CAN'T SLIP OUT OF PHILLIPS TAPERED RECESS

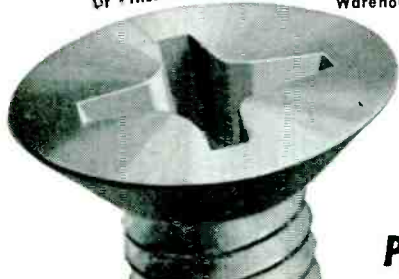

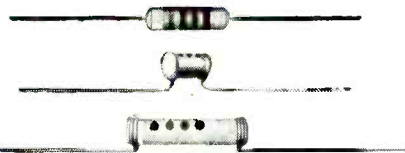

Erie "GP" ^{*}Molded Insulated Ceramics
5 MMF—5,000 MMF

Erie "GP" Dipped Insulated Ceramics
5 MMF—5,000 MMF.

Erie "GP" Non-Insulated Ceramics
5 MMF—5,000 MMF.

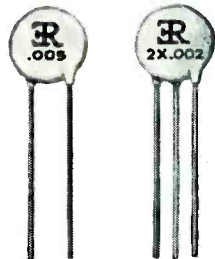

Erie Disc Ceramics
Up to .01 MFD



Cinch-Erie Plexicon ^{*}Tube
Sockets with 1,000 MMF
built in by-pass condensers

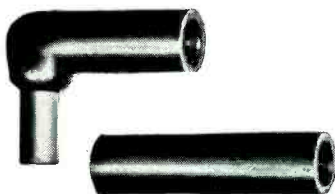

Types L-4, L-7, S-5 Suppressors
for Spark Plugs and Distributors

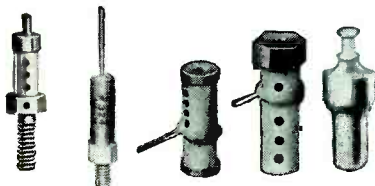

Type 720A Type 323 Type 2322 Type 2336 Type 325
and 324
Insulated

Erie Stand-Off Ceramics
5 MMF—5,000 MMF



Button Mica Condensers
15 MMF—6,000 MMF

Type 557
Ceramic
Trimmer



1.5-7 MMF
3-12 MMF
5-25 MMF
5-30 MMF
8-50 MMF

Type 554
Ceramic
Trimmer



Type 531 and 532
Tubular Trimmers
0.5-5 MMF
1-8 MMF



Type TS2A Ceramic Trimmer
1.5-7 MMF 3-13 MMF 4-30 MMF
3-12 MMF 5-20 MMF 7-45 MMF



Type 535

Tubular
Trimmer
.75-3 MMF

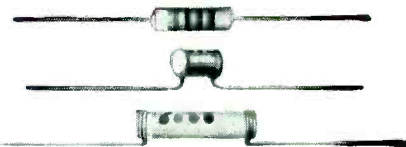

Temperature Compensating
Molded Insulated Ceramics ^{*}
0.5 MMF—550 MMF

Temperature Compensating
Dipped Insulated Ceramics
0.5 MMF—1,800 MMF

Temperature Compensating
Non-Insulated Ceramics
0.5 MMF—1,800 MMF



Type 357



Type 362

Feed-Thru Ceramics
5 MMF—1,000 MMF
5 MMF—1,500 MMF

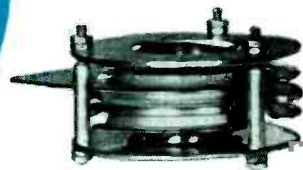

Type 3688

High Voltage Ceramics
Up to 15,000 Volts
WORKING

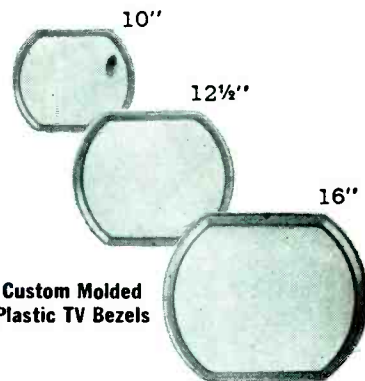

Custom Molded
Plastic TV Bezels



Custom Injection Molded
Plastic Knobs, Dials,
Bezels, Name Plates,
Coil Forms, etc.

for better
electronic products...
**ERIE RESISTOR
COMPONENTS**

The dependability and accuracy to close tolerances required for Television and Broadcast applications are combined in Erie Ceramics with compact design, tubular in form, for easy installation on the assembly lines.

Erie manufactures a complete line of Ceramic and Button Mica Condensers for transmitter and receiver applications: Carbon Suppressors, Custom Injection Molded Plastic Knobs, Dials, Bezels, Name Plates and Coil Forms. Our engineering department will work with you in developing specially designed components for efficient space-saving sub-assemblies. Complete technical information on request.

^{*}Ceramicon, Hi-K, GP, and Plexicon are registered trade names of Erie Resistor Corporation.

Electronics Division
ERIE RESISTOR CORP., ERIE, PA.
LONDON, ENGLAND • TORONTO, CANADA



First Thought **FOR VACUUM!**

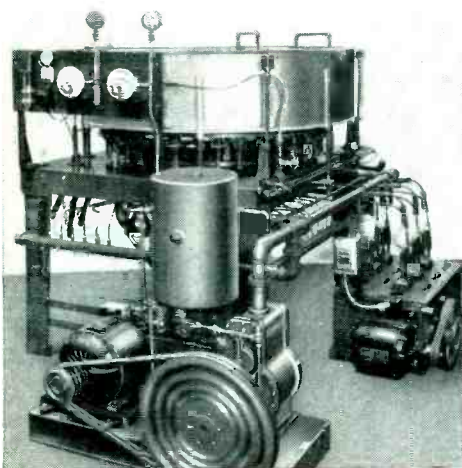
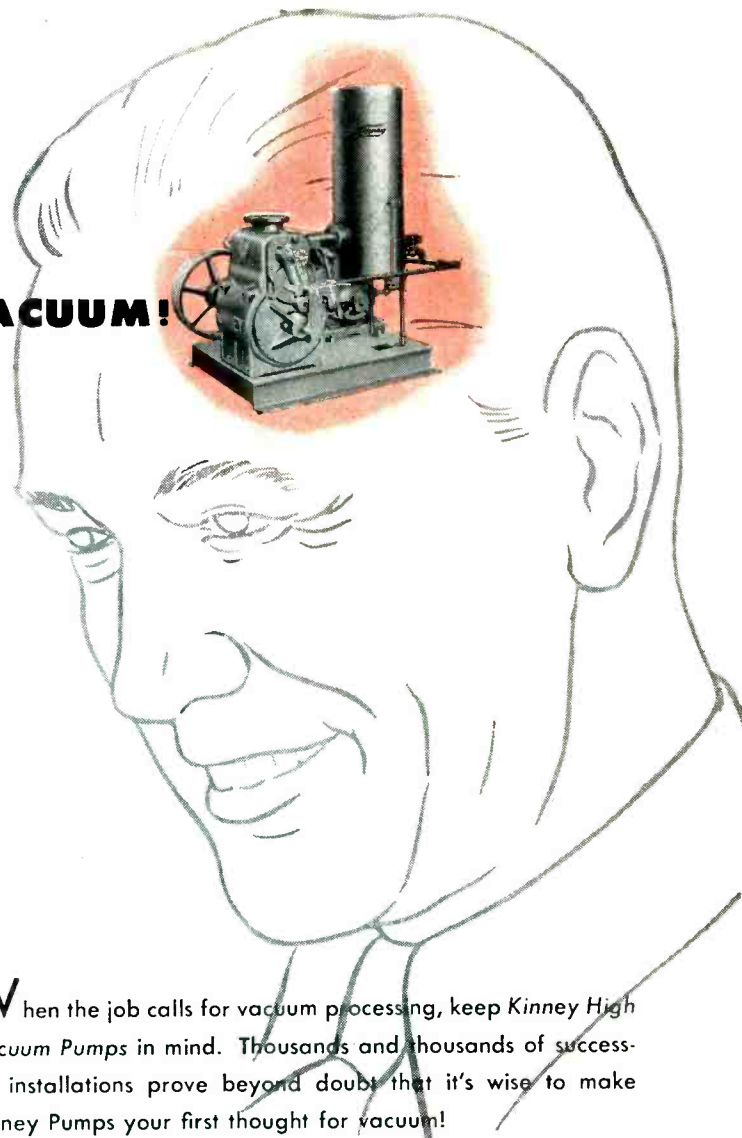

Eisler Radio Tube Machine showing Kinney Single Stage Pump used for initial pump-down and for backing Eisler Pump. The vacuum exhausting process is fast, sure, and extremely complete . . . making possible longer-lived, better performing tubes.

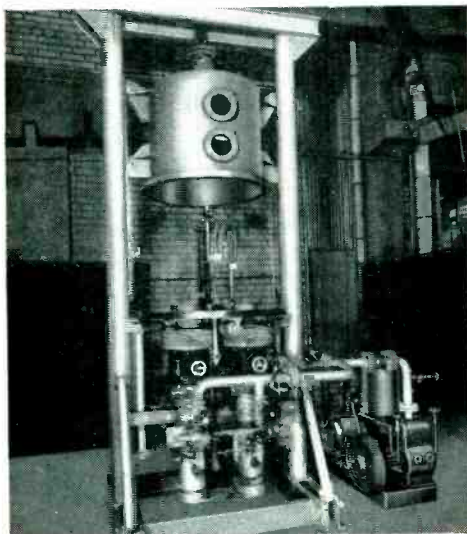

National Research Corporation high vacuum metallurgical furnace. Kinney Pump used for roughing and for backing diffusion pumps. In high vacuum furnaces metals like Titanium, Zirconium and Molybdenum are being cast or treated in the pure gas-free state. These vacuum-processed metals display new qualities of ductility and conductivity . . . new advantages made possible by Kinney-created low absolute pressures.

When the job calls for vacuum processing, keep *Kinney High Vacuum Pumps* in mind. Thousands and thousands of successful installations prove beyond doubt that it's wise to make Kinney Pumps your first thought for vacuum!

Why do so many modern vacuum processing systems employ Kinney Vacuum Pumps? Because these Pumps save processing time, because they conserve operating costs, and because they can be trusted on the job. If you want fast pump-down and minimum equipment "down-time", the Kinney Pump is the pump you need. Write for Bulletin V45, the complete story on Kinney High Vacuum Pumps and Equipment.

KINNEY MANUFACTURING CO., 3565 Washington St., Boston 30, Mass. Representatives in New York, Chicago, Cleveland, Houston, New Orleans, Philadelphia, Los Angeles, San Francisco, Seattle.

Foreign Representatives: General Engineering Co. (Radcliffe) Ltd., Station Works, Bury Road, Radcliffe, Lancashire, England . . . Horrocks, Roxburgh Pty., Ltd., Melbourne, C. I. Australia . . . W. S. Thomas & Taylor Pty., Ltd, Johannesburg, Union of South Africa . . . Novelectric, Ltd., Zurich, Switzerland . . . C.I.R.E., Piazza Cavour 25, Rome, Italy.

**Making old things better
Making new things possible**

KINNEY Vacuum Pumps

the 4-400A

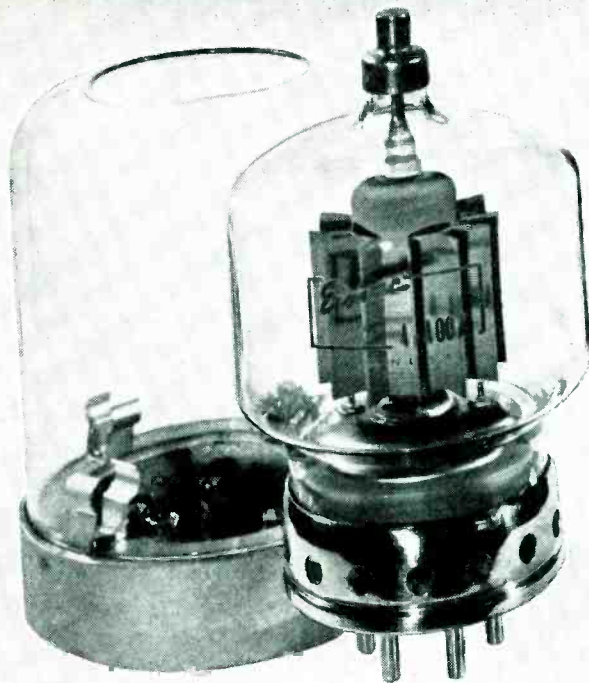

- ★ Long Life
- ★ Low Drive
- ★ RF Amplifier
- ★ Audio Amplifier
- ★ Simplified Cooling
- ★ Pyrovac Plate
- ★ Non-Emitting Grids
- ★ And . . . thoroughly proved in service.

EIMAC 4-400A POWER TETRODE
TYPICAL OPERATION
AUDIO FREQUENCY POWER AMPLIFIER
AND MODULATOR

Class AB₁ (Sinusoidal wave, two tubes,
unless otherwise specified)

DC PLATE VOLTAGE	3000	4000	Volts
DC SCREEN VOLTAGE	750	600	Volts
DC GRID VOLTAGE (approx.)*	-136	-116	Volts
ZERO SIGNAL DC PLATE CURRENT	160	130	Ma
MAX. SIGNAL DC PLATE CURRENT	620	510	Amp
ZERO SIGNAL DC SCREEN CURRENT	0	0	Ma
MAX. SIGNAL DC SCREEN CURRENT	28	10	Ma
EFFECTIVE LOAD PLATE TO PLATE	9200	16,000	Ohms
PEAK AF GRID INPUT VOLTAGE (per tube)	136	116	Volts
DRIVING POWER	0	0	Watts
MAX. SIGNAL PLATE POWER OUTPUT	1100	1280	Watts

*Adjust to give stated zero-signal plate current.

A pair of Eimac 4-400A tetrodes provides the ideal answer for a one-kilowatt AM or FM broadcast power amplifier stage. The 400-watt plate dissipation rating of these tubes allows extremely conservative operation at the 1-kw level, thus assuring long, trouble-free tube operation.

In AM service, the 4-400A is FCC rated for 500 watts output per tube in high level modulated amplifiers. In FM applications, the superlative performance of the 4-400A at VHF allows an easy 1-kw of useful power output from a pair of tubes.

The low driving-power requirement of these tetrodes allows the driving equipment to be reduced to simple low power stages employing low cost tubes. The rugged construction of the 4-400A, plus a Pyrovac plate and the use of other time-proven materials and manufacturing processes, contributes to the tube's long life and ability to withstand both physical and electrical abuse.

To simplify transmitter design, an Eimac air system socket and chimney assembly is available for the 4-400A. This assembly provides a balanced flow of cooling air to the tube with minimum air waste, as well as completing the shielding between input and output circuits.

The low driving-power required by the 4-400A makes it an ideal choice for audio as well as r-f application. High audio power at low distortion can easily be obtained with zero driving power. (See accompanying data.)

For tube economy in one-kilowatt equipment, consider the service-proven 4-400A developed by America's foremost tetrode manufacturer . . . Eimac. Complete technical data are available . . . write today.

Follow the Leaders to

Eimac
TUBES
The Power for R-F

EITEL-McCULLOUGH, INC.
San Bruno, California

Export Agents: Frazer & Hansen, 301 Clay St., San Francisco, California

COPPER ALLOY BULLETIN

REPORTING NEWS AND TECHNICAL DEVELOPMENTS OF COPPER AND COPPER-BASE ALLOYS

Prepared Each Month by BRIDGEPORT BRASS COMPANY "Bridgeport" Headquarters for BRASS, BRONZE and COPPER

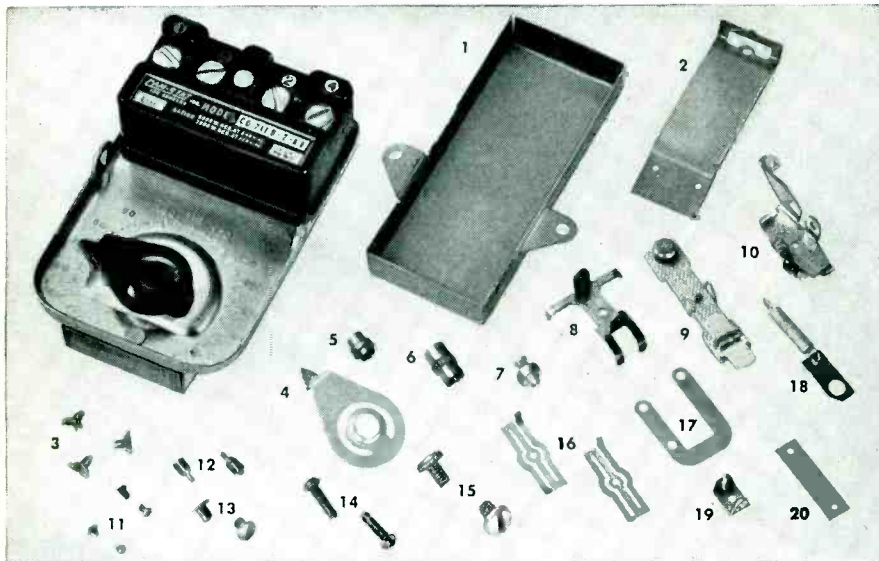

Hot water thermostat and component parts—Courtesy Camstat, Inc., Los Angeles, Calif.

Seven Copper Alloys Resist Corrosion in Bi-Metal Switch

Rusting and other forms of corrosion change the electrical characteristics of parts, decrease strength of springs and jam bearing points in small control instruments.

To combat such conditions, copper-base alloys were primarily selected for all functional parts in the illustrated water heater thermostat. This unit operates with a bi-metal actuator which curves forward as the result of one metal expanding more rapidly than another.

Since each copper alloy has different mechanical and physical characteristics, seven were used in this unit, and, in some cases, several tempers for each alloy.

Cartridge brass, 70% copper and 30% zinc, because of its ability to withstand heavy working better than high brass, is used for the cover (1), bracket (2), pointer (4), yoke (9), and staple

(3). Half hard metal was necessary to permit drawing, forming and bending of the cover, pointer and yoke, and in the staple to permit the prongs to be bent at assembly. The bracket is spring hard (8 numbers) as it acts as a flat spring.

Phosphor bronze Grade A, 95% copper, 5% tin, 0.15 phosphor, produces flat springs in light gages (0.006 and up) due to its excellent spring properties and resistance to fatigue. This alloy is used for the contact springs (16), push button spring (17), spring link (18) and flat spring (20). All have spring temper.

Nickel Silver Grades A, B

Two grades of Nickel silver find use in this unit. In the pivot bracket (8) grade B, 55% copper, 18% nickel and the remainder zinc, gives the part fine spring characteristics, high strength (better than 90,000 psi in its extra hard temper), and the ductility in this hard

state to permit heavy bending and forming.

Grade A, 65% copper, 18% nickel and remainder zinc, has greater ductility than B which permits dimpling, bending and forming on the actuating lever (10). The base metal is hard (4 numbers) and has a tensile strength of 85,000. The coldworking done on this lever increases its strength to around 90,000.

Several Parts Machined

Free machining brass rod, with the highest machinability of the copper alloys, can be accurately machined with good finishes at high speeds. For these reasons, it is used for the counterweight (shown on assembly 9), adjusting nut (5), terminal (6), stub (7), and calibrating screw (12). This alloy also has a conductivity 26% that of copper.

The hollow rivets (11) and (13) are produced in cold headers from 70-30 (cartridge brass) wire. When the hollow rivets are such that drilling is required rather than extrusion in the header, a light leaded wire is used (65% copper, 0.3% lead and remainder zinc) to facilitate the drilling.

The cold headed and roll threaded screws (14) and (15) are made from high brass, 65% copper, 35% zinc. Although not as ductile as the cartridge brass used in the hollow rivets, it is sufficiently ductile for medium-sized heads and roll threading.

Silver Rivets

The hollow rivets used for electrical contacts in the switch under the silver links are also of silver to eliminate danger of arcing.

Bridgeport's laboratory can be of help to product engineers in the selecting of the best alloy from a functional as well as fabricating standpoint. Write the nearest district office or contact Bridgeport directly.

BRASS • BRONZE • COPPER • DURONZE — STRIP • ROD • WIRE • TUBING

MILLS IN
BRIDGEPORT, CONNECTICUT
INDIANAPOLIS, INDIANA

In Canada:
Noranda Copper and Brass Limited,
Montreal



BRIDGEPORT BRASS COMPANY
BRIDGEPORT 2, CONNECTICUT

Established 1865

"Bridgeport" District Offices and Warehouses in Principal Cities

Measuring Split Seconds . . . with the help of Holtzer-Cabot motors!

This ingenious electronic device, made by American Time Products, Inc., tells in 30 seconds exactly how fast or how slow any watch is running per 24 hours (a job that used to require weeks of checking). Here's how it works: — the ticks of a watch, picked up by a sensitive crystal microphone, activate a stylus which prints a dot for each tick on a revolving chart drum. The pattern made by these dots indicates the slightest variation of time-keeping accuracy, and also indicates the cause of any irregularity.

Designing a suitable motor for this high-precision instrument presented a difficult problem, due to the demanding specifications of the application:



- The motor must rotate the drum with an accuracy of one part in one hundred thousand.
- The motor must be exactly synchronous.
- It must have the necessary torques to operate the mechanical system with a margin of safety.
- The velocity of rotation must be perfectly smooth and uniform.
- The motor must be free from all electrical and mechanical noises which might be picked up by the microphone.

Holtzer-Cabot engineers were called in at the prototype stage and, working with American Time Products' engineers, met all requirements by designing a modification of the Holtzer-Cabot RWC 2505 synchronous motor. Result — years of trouble-free performance in the field.

This is just another example of Holtzer-Cabot's ability to meet the most demanding specifications in small-motor applications. Holtzer-Cabot motors range from 1/2000 up through 1½ H.P.; from 24,000 RPM to 1 revolution per day!

HOLTZER-CABOT



DIVISION OF NATIONAL PNEUMATIC CO., INC.

BOSTON 19, MASSACHUSETTS

builders of fine electric motors for three quarters of a century

INVESTIGATE NOW . . . Holtzer-Cabot welcomes inquiries involving special motors.

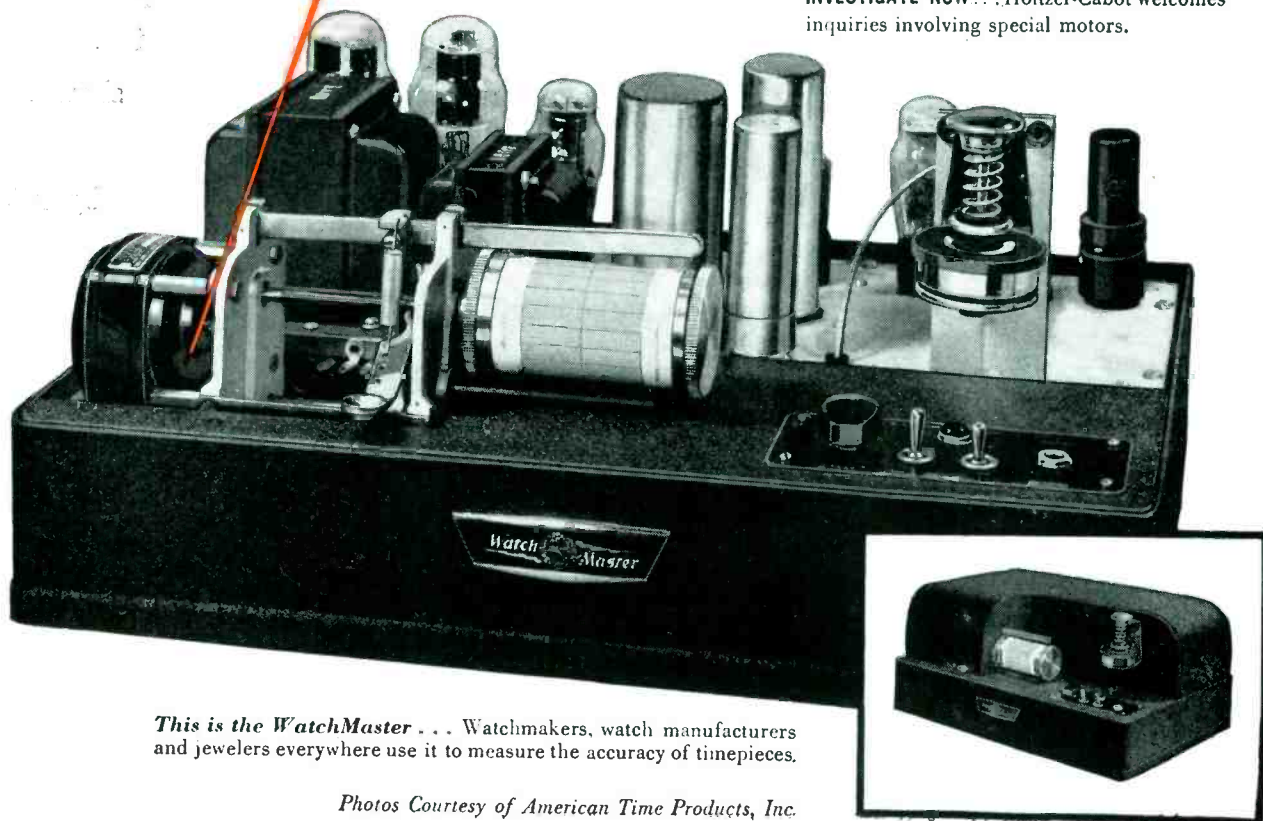

This is the WatchMaster . . . Watchmakers, watch manufacturers and jewelers everywhere use it to measure the accuracy of timepieces.

Photos Courtesy of American Time Products, Inc.

*Can you suggest
a good use for*

PRESSED BOARD ?



Recently, we completed a new plant,
devoted exclusively to the fabrication of pressed board.
We feel certain it will be of great service to the television industry.
We are already producing the pressed board television backs shown.
Somewhere in your product there may be other parts,
now made of metal, that can be made more economically out
of pressed board. What is it? Our engineers
welcome a challenge. Write us today.

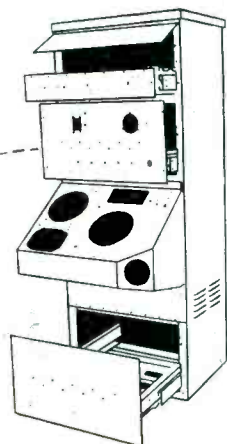

DONNELLY MANUFACTURING

A DIVISION OF JOHN DONNELLY & SONS
3134 WASHINGTON ST., BOSTON, MASS.



PRECISION SHEET METAL & PRESSED WOOD FABRICATION

WRITES

WITH ELECTRICITY

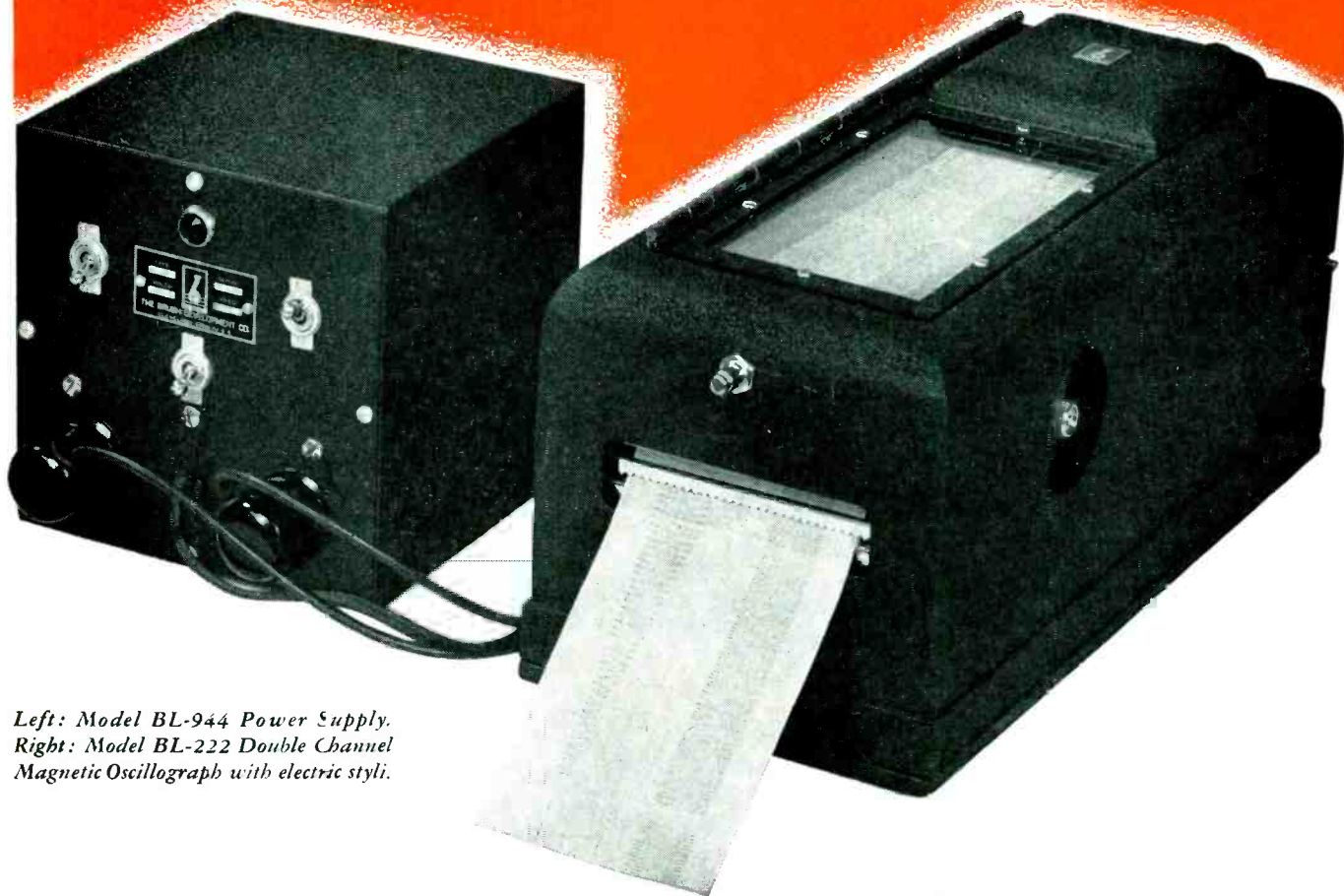

Left: Model BL-944 Power Supply.
Right: Model BL-222 Double Channel
Magnetic Oscillograph with electric styli.

New BRUSH Combination Oscillograph has interchangeable electric styli and inking pen

● To improve the recording of variable phenomena under extreme conditions such as high or low room temperatures, The Brush Development Company introduces the Model BL-221 Single Channel and Model BL-222 Double Channel Combination Magnetic Oscillographs for use with either electric styli or inking pen. These combination units are furnished with Model BL-944 Electric Stylus Power Supply, electric styli, inking pen, inkwell and both standard and electric-recording chart paper.

The Model BL-944 Power Supply, shown above on the left, has a switch on the front panel to increase styli voltage for recording high frequency phenomena.

Write for details on these new Brush instruments... or for information on conversion of standard direct-inking oscillographs to combination types.

THE *Brush* DEVELOPMENT COMPANY

3405 Perkins Avenue, Cleveland 14, Ohio, U. S. A.
Canadian Representatives: A. C. Wickman (Canada) Ltd., P. O. Box 9
Station N, Toronto 14, Ontario

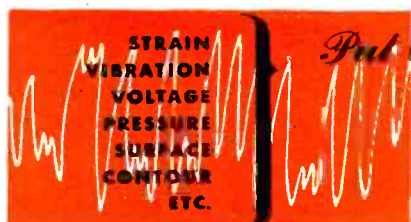

Put it in writing with a

BRUSH RECORDING ANALYZER

STRAIN ANALYZERS • SURFACE ANALYZERS • CONTOUR ANALYZERS • UNIVERSAL ANALYZERS • UNIFORMITY ANALYZERS



ANTARA PRODUCTS

GENERAL ANILINE & FILM CORPORATION
444 MADISON AVENUE · NEW YORK 22, N.Y.

an open letter

October, 1950

To All Users of Powdered Iron Cores
Anywhere, U. S. A.

Next time your order is placed for cores, ask your core maker this question: What material do you use in these cores?

If his answer is Carbonyl Iron Powders, good. He's using the highest quality material on the market. If he gives you another name, ask yourself this question: Can I be sure of high Q, of temperature and atmospheric stability at no extra cost? Can I be sure I'm getting the finest core possible if he doesn't use Carbonyl Iron Powders?

The answer is obvious. Your core maker can supply you with the best -- if he uses GA&F Carbonyl Iron Powders. Ask your core maker next time you place an order. See for yourself what a difference these low-cost, high Q materials can make!

Sincerely,

ANTARA PRODUCTS
General Aniline & Film Corporation

GA & F[®] Carbonyl

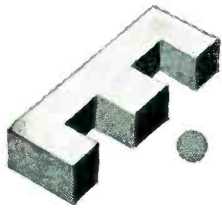

to all users of powdered iron cores . . .



Core users—here's a tip that will guarantee you cores made of the highest quality materials on the market. Ask your core maker for cores made with Carbonyl Iron Powders. You will guarantee yourself high quality cores because Carbonyl Iron Powders are high quality products with low loss characteristics. They are manufactured and tested for quality under the most rigid conditions.

It costs no more to secure Carbonyl Iron Powder cores. On a performance basis, they offer savings not possible with other magnetic powder.

Your core maker knows about these high Q materials. He is familiar with their stability, their ease of insulation, and the controlled particle size distribution. That's why we say, next time you order, insist on Carbonyl Iron Powders for best results!

THIS FREE BOOK — fully illustrated, with performance charts and application data — will help any radio engineer or electronics manufacturer to step up quality, while saving real money. Kindly address your request to Dept. 56.



ANTARA® PRODUCTS

GENERAL
GA NILINE & FILM CORPORATION

444 MADISON AVENUE

NEW YORK 22, N. Y.

Iron Powders . . .



A

RELIABLE SOURCE

OF SUPPLY *for*

DEPENDABLE RESISTORS

for OVER 20 YEARS

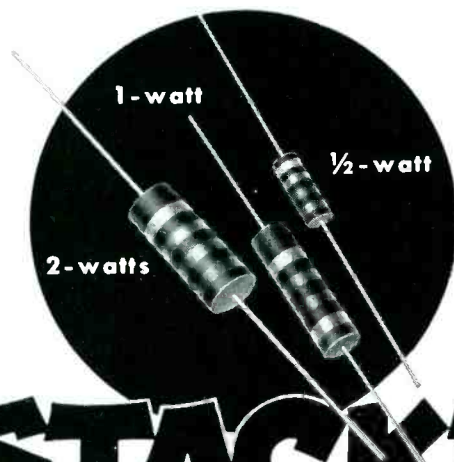

STACKPOLE

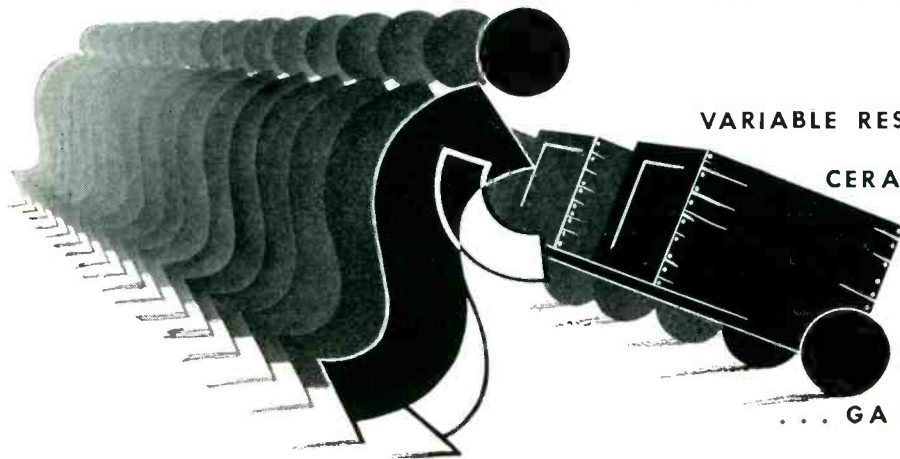

... FIXED RESISTORS

VARIABLE RESISTORS ... IRON CORES ...

CERAMAG® CORES ... LINE, SLIDE

AND ROTARY SWITCHES ...

CARBON VOLTAGE REGULATOR

DISCS ... MOLDED COIL FORMS

... GA "GIMMICK" CAPACITORS, ETC.

Electronic Components Division

STACKPOLE CARBON COMPANY

ST. MARYS, PA.



Precision Voltmeters... FAST ACCURATE READINGS

2 cps to 700 mc

ANOTHER -hp- SERVICE

Person-to-Person Help With Your Measuring Problems

Almost anywhere in America, -hp- field representatives can give you personal help with your measuring problems. They have complete data on -hp- instruments, their performance, servicing and adaptability. Call the nearest -hp- field representative whenever, wherever you need help with a measuring problem.

ALBUQUERQUE, NEW MEXICO

Neely Enterprises
302½ W. Central Ave., Albuquerque 3-2245

BOSTON 16, MASSACHUSETTS

Burlingame Associates
270 Commonwealth Ave., Kenmore 6-8100

CHICAGO 40, ILLINOIS

Alfred Crossley & Associates
4501 Ravenswood Ave., Uptown 8-1141

CLEVELAND 15, OHIO

M. P. Odell Co.
2536 Euclid Ave., Prospect 1-6171

DALLAS 5, TEXAS

Earl Lipscomb Associates
4433 Stanford St., Logan 6-5097

DAYTON 2, OHIO

Alfred Crossley & Associates
410 W. First St., Michigan 8721

DENVER 3, COLORADO

Ronald G. Bowen
852 Broadway, Acoma 5211

DETROIT 5, MICHIGAN

S. Sterling Company
1331 Linwood Ave., Townsend 8-3130

FORT MYERS, FLORIDA

Arthur Lynch & Associates
P. O. Box 466, Fort Myers 1269M

HOUSTON 5, TEXAS

Earl Lipscomb Associates
3919 Riley St., Linden 9303

HIGH POINT, NORTH CAROLINA

Bivins & Caldwell
Rm. 807, Security Bk. Bldg., High Point 3672

LOS ANGELES 46, CALIFORNIA

Neely Enterprises
7422 Melrose Ave., Whitney 1147

NEW YORK 13, NEW YORK

Burlingame Associates
103 Lafayette St., Digby 9-1240

PHILADELPHIA 44, PENN.

Burlingame Associates
422 Coulter St., Tennessee 9-2006

SAN FRANCISCO 3, CALIFORNIA

Neely Enterprises
954 Howard St., Douglas 2-2609

ST. LOUIS 3, MISSOURI

Harris-Hanson Company
208 North 22nd St., Main 5-164

SYRACUSE, NEW YORK

Burlingame Associates
712 State Tower Bldg., Syracuse 2-0194

TORONTO 2-B, ONTARIO, CANADA

Atlas Radio Corporation, Ltd.
560 King St. West, Waverley 4761

WASHINGTON 9, D. C.

Burlingame Associates
2017 S Street N. W., Decatur 8000

-hp- MODEL 400C



From 2 cycles to 700 megacycles, there's an accurate, easy-to-operate -hp- voltmeter to fit every voltage measurement requirement. You can choose from 5 precision voltmeters (including a battery-operated instrument) the ones which precisely fill your measuring need. Each has the familiar -hp- characteristics of high sensitivity, wide range, versatility, compact size, and time-saving ease of operation. These -hp- precision voltmeters are used by radio stations, manufacturers, research laboratories and scientific men throughout the world.

INSTRUMENT	FREQ. RANGE	VOLTAGE RANGE	ACCURACY	INPUT IMPEDANCE	PRICE
-hp- 400A	10 cps to 1 mc	.005 to 300 v 9 ranges	Within 3%	1 meg., 16 μ fd shunt	\$185.00
-hp- 400B	2 cps to 100 kc	.005 to 300 v 9 ranges	Within 3%	10 meg., 20 μ fd shunt	195.00
-hp- 400C	20 cps to 2 mc	.0001 v to 300 v 12 ranges	Within 3%	10 meg., 15 μ fd shunt	200.00
-hp- 404A (Battery Op'd.)	2 cps to 50 kc	.0005 v to 300 v 11 ranges	Within 5%	10 meg., 20 μ fd shunt	185.00
-hp- 410A	20 cps to 700 mc	0.1 v to 300 v 7 ranges	Within 3%	10 meg., 1.3 μ fd shunt	245.00

For complete data on any -hp- instrument, write direct to factory or contact the nearest -hp- technical representative.

HEWLETT-PACKARD CO.

1876-A PAGE MILL ROAD • PALO ALTO, CALIF.

Export Agents: Frazar & Hansen, Ltd.

301 Clay Street, San Francisco 11, California, U.S.A.

hp laboratory instruments
FOR SPEED AND ACCURACY

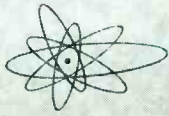

Designers



PANEL INSTRUMENTS—A COMPLETE LINE

Accurate and Reliable

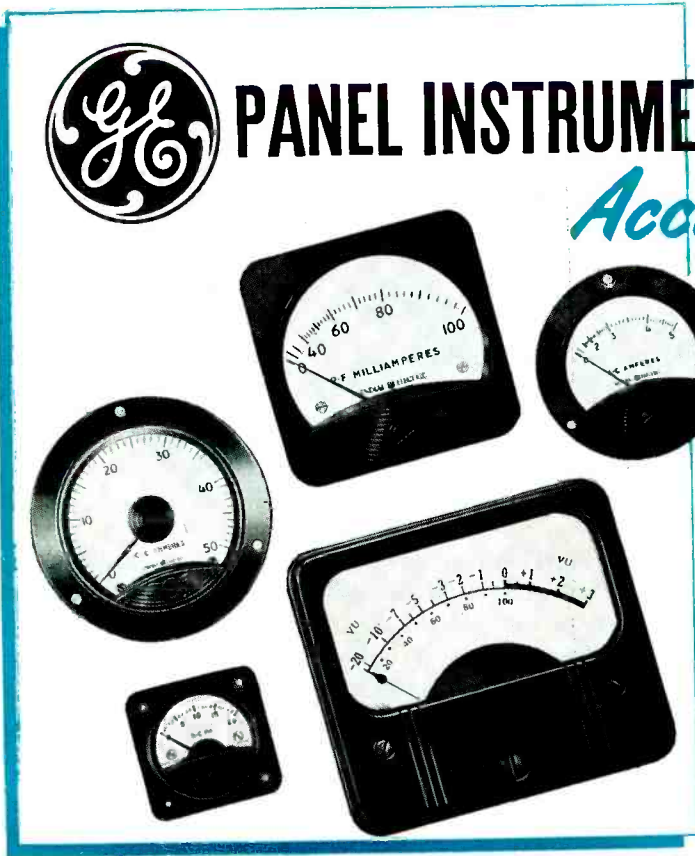

FOR MEASURING D-C, A-C, RF, AF, VU

General Electric panel instruments have long been known for their reliability and accuracy. Recent design changes provide for better performance, readability, durability, and appearance. G-E voltmeters, kilovoltmeters, ammeters, milliammeters, microammeters, and vu volume-level indicators; thermocouple types and rectifier types; round or square, with conventional or long 250-degree scales—all will give your measurements the accuracy required and your panel that smooth, modern appearance. To bring you up to date on the latest improvements in cases, faces, and mechanisms, G.E. offers a comprehensive 24-page bulletin containing all information necessary for ordering. Write for Bulletin GEC-368. For vu indicators, see Bulletin GEC-369.

SOLVE DESIGN PROBLEMS WITH THE SWITCH OF 10,000 USES

A member of the well known SB-1 switch family can find a useful place on almost any large electronic control panel. The precision-built parts of this all-purpose switch permit as many as 40 stages—four banks of ten stages each—to be operated in tandem. Switches with up to 16 stages and 12 positions are commonly furnished. Over 10,000 circuit-sequence combinations are possible. Ratings go to 20 amperes at 600 volts a-c or d-c. See Bulletin GEC-270.

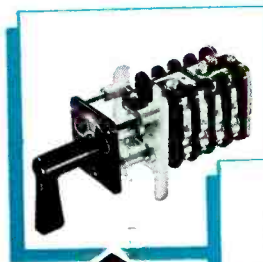

SB-1 switch, cover-removed

SAVE PANEL SPACE WITH ONE-UNIT PUSH-BUTTON AND INDICATING LIGHT

Illuminated push button



This space-saving pilot-circuit switch consists of a sturdy push-button unit, 2 3/8 inches high, with a hollow translucent cap and 6-volt lamp. The switch is the momentary contact type, single-pole, with one normally open and one normally closed circuit. It uses movable-disk type contacts. Buttons are supplied in clear, red, green, blue, amber, and white. For more data on this and other G-E push-button units, see Bulletin GEA-4254.

GENERAL  **ELECTRIC**

Digest

TIMELY HIGHLIGHTS ON G-E COMPONENTS

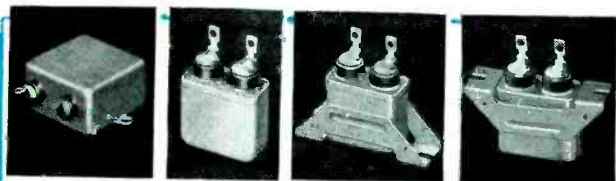

PERMAFIL CAPACITORS

NO DERATING AT 125° C OPERATION

For operation at high ambient temperatures, these standard-line G-E Permafil capacitors are naturals. They're paper dielectric units and can be used at temperatures up to 125° C without derating. All are metal encased, compression-sealed, and have long-life silicone bushings. Ratings: up to 2 muf for operation at 400 volts d-c and below. Case styles: 53, 61, 63, and 65 (JAN-C-25 specifications). For more data, write Capacitor Sales Div., General Electric Co., Pittsfield, Mass.



INDUCTROLS

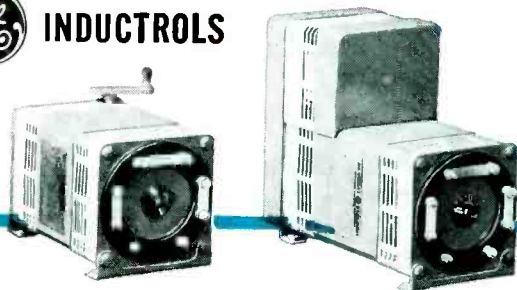

STEPLESS VOLTAGE VARIATION

Inductrols are G-E dry-type induction voltage regulators for 120 and 240-volt operation. Hand-operated models provide smooth and extremely precise voltage adjustment for such uses as instrument calibration and rectifier control. Motor-operated models are used with automatic control to maintain voltage within narrow limits, irrespective of supply variations. Sizes range from 10¼ x 6½ x 7⅞ inches for the smallest hand-operated unit to 14 x 6 x 10⅞ for the largest motor-operated unit. One unit provides a voltage range of 10% raise and lower on 3 and 6-kva circuits, another gives 100% raise and lower for 2.4 and 3.6 kva circuits. Complete information in Bulletin GEA-4508.

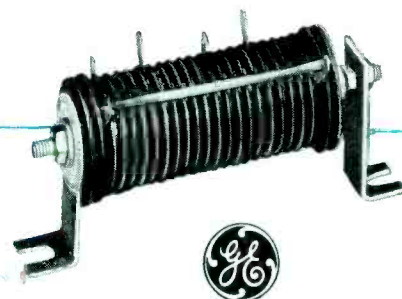

HIGH-VOLTAGE SELENIUM RECTIFIERS

WITH LIFE EXPECTANCY OF 60,000 HOURS!

Now available from G.E. are 26-volt RMS selenium rectifier cells with a continuous-service life expectancy of over 60,000 hours. Their initial forward resistance is very low and samples show an average increase in resistance of less than 6% after 10,000 hours of operation. General Electric knows of no other high-voltage selenium cell on the market that can even approach their performance.

The high output voltage permits the design of smaller stacks while the low resistance means cooler operation and the space saving that goes with it.

Stacks made with the new G-E cells may be obtained with rated outputs from 18 to 126 volts d-c at .15 to 3.75 amps. Write now for Bulletin GEA-5280.

General Electric Company, Section E667-7
Apparatus Department, Schenectady 5, N. Y.

Please send me the following bulletins:

- | | | |
|--------------|--------------------------|------------------------------------|
| Indicate | <input type="checkbox"/> | GEA-4254 Push-button units |
| for | <input type="checkbox"/> | GEA-4508 Inductrols |
| reference | <input type="checkbox"/> | GEA-5280 Selenium rectifiers |
| only (✓) | <input type="checkbox"/> | GEC-270 SB-1 switch |
| for planning | <input type="checkbox"/> | GEC-368 Panel instruments |
| an immediate | <input type="checkbox"/> | GEC-369 Vu volume-level indicators |
| project (X) | | |

NAME _____

COMPANY _____

ADDRESS _____

CITY _____ STATE _____

NO OTHER TESTER

does so much... so well!



WESTON
Model 785
INDUSTRIAL CIRCUIT TESTER

In the shop . . . 28 ranges in one case to locate circuit troubles on production equipment.
On the bench . . . 28 ranges in one case for checking electrical equipment during manufacture.
In the lab . . . 28 ranges in one case immediately available for research and development work.

28 Instrument Ranges

D-C VOLTS: 100 mv, 1/10/50/200/500/1000 volts (20,000 ohms per volt).

A-C VOLTS: 5/15/30/150/300/750 volts.

D-C CURRENT: 50 microamps; 1/10/100 milliamps; 1/10 amps.

A-C CURRENT: .5/1/5/10 amps.

RESISTANCE: 3000/30,000/300,000 ohms; 3/30 megohms.

Stock Accessories Available for Extending Above Ranges

It does *so much, so well, for so little.* Check your Weston Representative for full details or see your local jobber. Weston Electrical Instrument Corporation, 618 Frelinghuysen Avenue, Newark 5, New Jersey . . . manufacturers of Weston and Tagliabue Instruments.

WESTON *Instruments*

Albany • Atlanta • Boston • Buffalo • Charlotte • Chicago • Cincinnati • Cleveland • Dallas • Denver • Detroit • Houston • Jacksonville • Knoxville • Little Rock • Los Angeles • Meriden • Minneapolis • Newark • New Orleans
New York • Orlando • Philadelphia • Phoenix • Pittsburgh • Rochester • San Francisco • Seattle • St. Louis • Syracuse • Tulsa • Washington, D. C. • In Canada, Northern Electric Company, Ltd., Powerlite Devices, Ltd.



Let **OHMITE** Engineers **BACK UP Your Engineers**

IN SOLVING YOUR RESISTANCE PROBLEMS

The valuable time of your engineering staff can be conserved appreciably by letting Ohmite help solve your difficult resistance problems. Because Ohmite engineers are resistance specialists, they can quickly analyze your requirements and recommend the correct rheostats and resistors—or frequently a moneysaving combination—for your particular application. Both Ohmite's engineering help and its laboratory facilities are available to you for the asking. Years of experience in building dependable resistance units . . . and in helping others to economically solve their resistance problems . . . are your assurance Ohmite can help you.

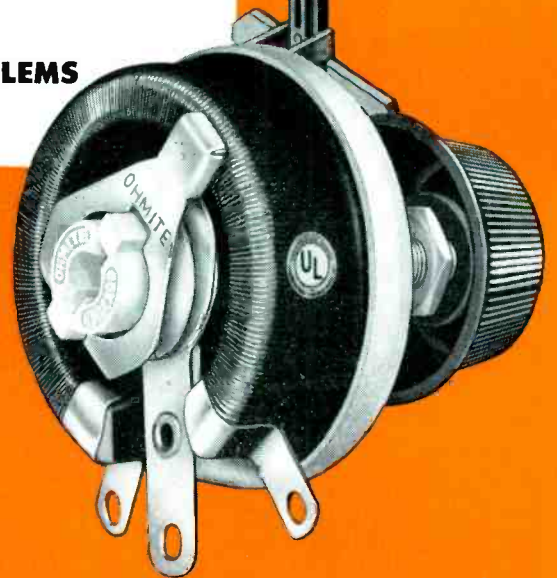

Be Right with- **OHMITE**

Reg. U. S. Pat. Off.

*Industry's **FIRST** Choice in RHEOSTATS • RESISTORS • TAP SWITCHES*

The Most Complete Line of Wirewound Resistors . . .

The **OHMITE** Line

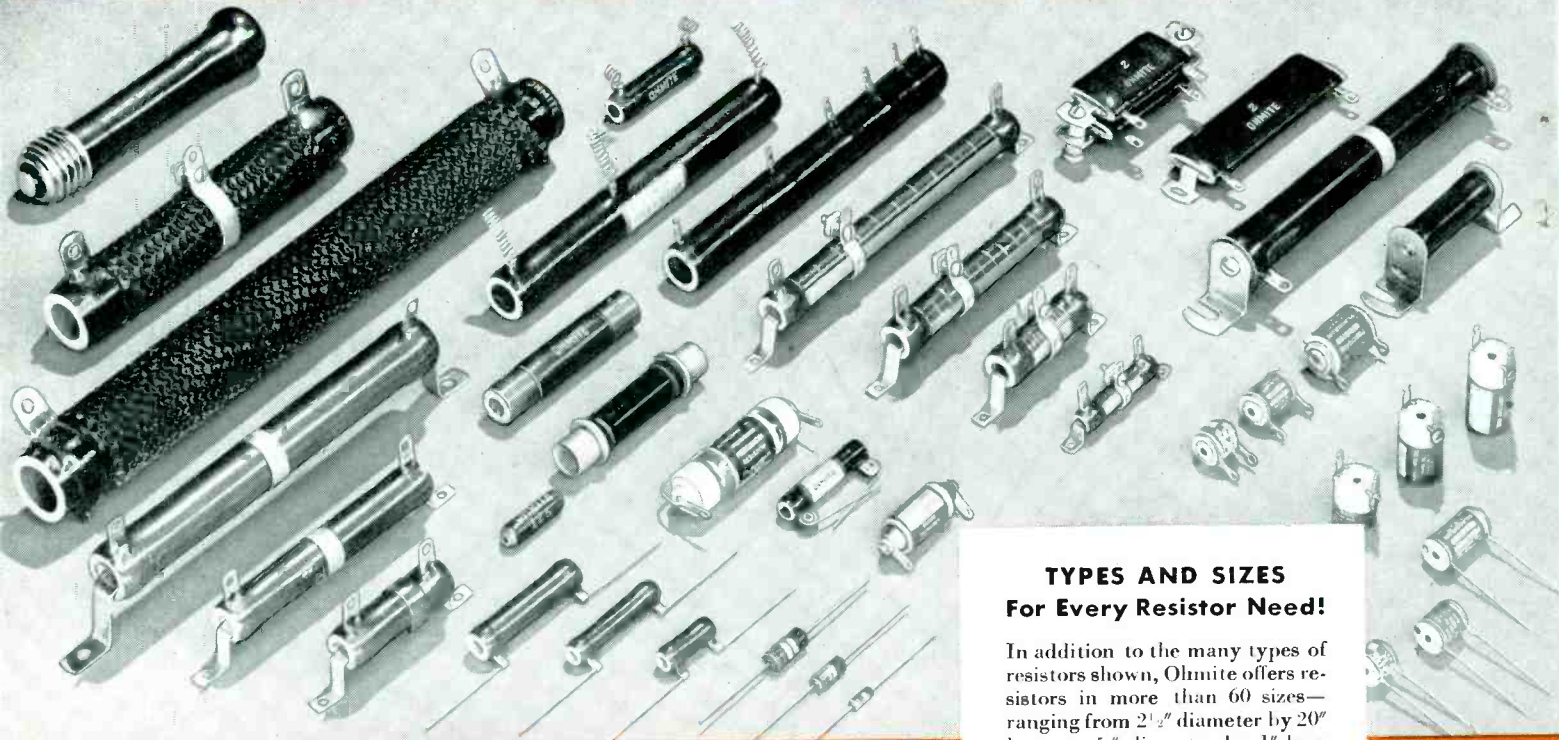

TYPES AND SIZES For Every Resistor Need!

In addition to the many types of resistors shown, Ohmite offers resistors in more than 60 sizes—ranging from 2 1/2" diameter by 20" long, to 5/16" diameter by 1" long—to meet your exact requirements. Many sizes are carried in stock.

No matter what your resistor requirements, the chances are that Ohmite has exactly the resistor you need. Ohmite offers fixed, adjustable, tapped, non-inductive, and precision-type resistors in many sizes, types of terminals, and in a wide range of wattage and resistance values. Ohmite application engineers will be pleased to help in the selection of the right resistor for your needs.

OHMITE MANUFACTURING CO.
4817 Flournoy St., Chicago 44, Illinois

Write on Company Letterhead
for Catalog 40

Be Right with

OHMITE

Reg. U. S. Pat. Off.

RHEOSTATS • RESISTORS • TAP SWITCHES

Industry's First Choice

MANY TYPES OF TERMINALS



LUG TYPE



WIRE LEAD



INTEGRAL FLEXIBLE LEAD



LUG MOUNTED FLEXIBLE LEAD



EDISON SCREW BASES



CUP STYLE FERRULES



SLEEVE STYLE FERRULES



CARTRIDGE STYLE FERRULES

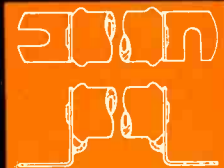

LIVE BRACKETS



**BROWN
INSTRUMENTS
ACCELERATE
RESEARCH**

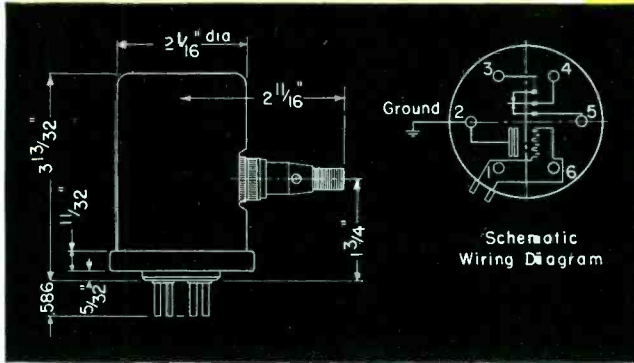
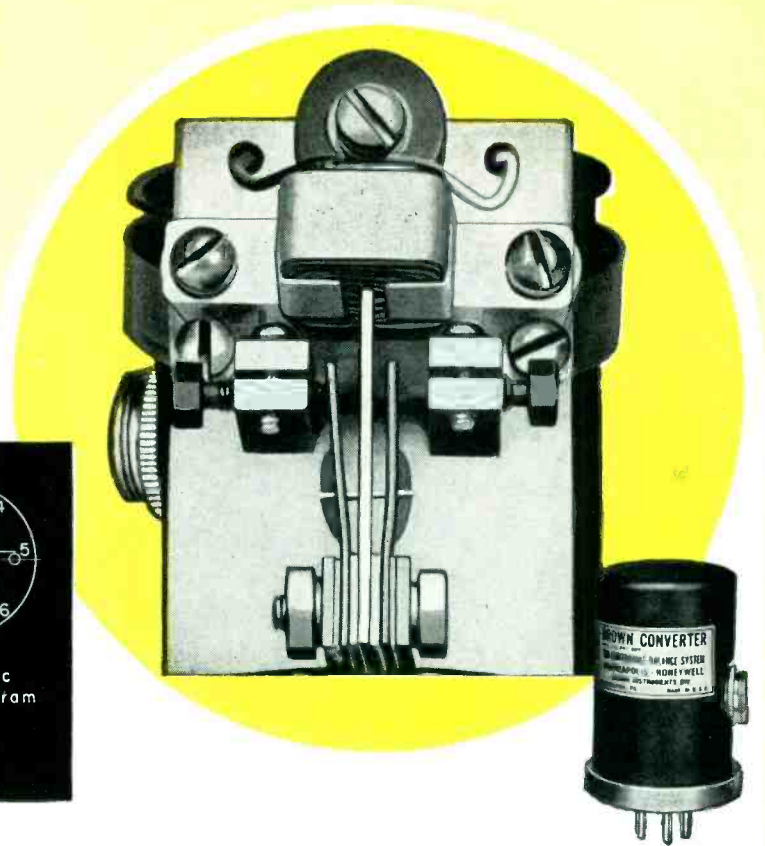

Combines Longevity and Dependability

...The Brown 400 Cycle Converter

ELECTRICAL CHARACTERISTICS

DRIVING COIL REQUIREMENTS—18 volts, 94 milliamperes, 400 cycles \pm 10 per cent.

CONTACT RATING—SPDT switching. Nominal rating, 28 volts to one microvolt, 1.0 milliampere; maximum power, 100 microwatts.

SWITCHING ACTION—Each contact closed 55 per cent of each cycle, closed simultaneously 5 per cent of the time.

SYMMETRY—Within 5 per cent.

LOAD CHARACTERISTICS—Resistive or inductive.

SHIELDING—Shell and coil shields, both grounded through pin No. 2.

VIBRATION RESISTANCE—Output voltage will vary less than 2 per cent, with rates of vibration from 0 to 10 g.

PHASE SHIFT—Output voltage differs from that of driving voltage by 45 to 50 degrees.

STRAY PICK-UP—Sufficiently low for the measurement of a one microvolt d-c signal after amplification by a suitable audio frequency amplifier.

Practically identical to the service-proved 60 cycle converter used in the Brown line of *ElectroniK* precision instruments, this component is ideal for use with any system involving the conversion of low-power direct voltage signals of the order of 100 microvolts to 400 cycle alternating voltages. It is particularly useful for applications requiring error voltage measurements or null detection. The design and arrangement of its contacts practically eliminate electrostatic stray potential pick-up. For detailed information, write for a copy of Data Sheet 10.20-1. MINNEAPOLIS-HONEYWELL REGULATOR Co., Industrial Division, 4428 Wayne Ave., Phila. 44, Pa. Offices in more than 80 principal cities of the United States, Canada and throughout the world.

MINNEAPOLIS
Honeywell

BROWN INSTRUMENTS

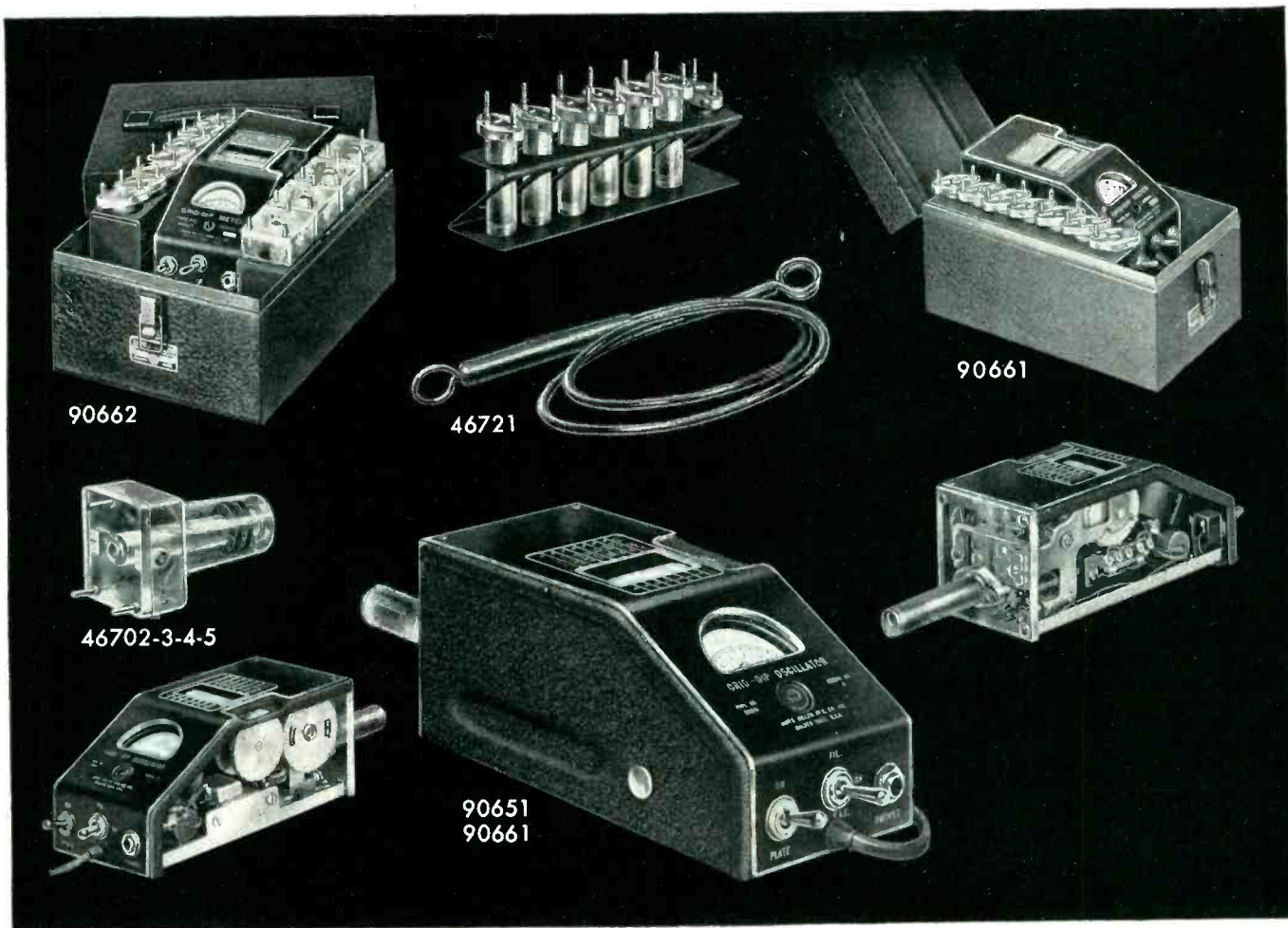

Designed for Application **GRID DIP METERS**

Millen Grid Dip Meters are available to meet all various laboratory and servicing requirements.

The 90662 Industrial Grid Dip Meter completely calibrated for laboratory use with a range from 220 kc. to 300 mc. incorporates features desired for both industrial and laboratory application, including three wire grounding type power cord and suitable carrying case.

The 90661 Industrial Grid Dip Meter is similar to the 90662 except for a reduced range of 1.7 to 300 mc. It likewise incorporates the three wire grounding type cord and metal carrying case.

The 90651 Standard Grid Dip Meter is a somewhat less expensive version of the grid dip meter. The calibration while adequate for general usage is not as complete as in the case of the industrial model. It is supplied without grounding lead and without carrying case. The range is 1.7 to 300 mc. Extra inductors available extends range to 220 kc.

The Millen Grid Dip Meter is a calibrated stable RF oscillator unit with a meter to read grid current. The frequency determining coil is plugged into the unit so that it may be used as a probe.

These instruments are complete with a built-in transformer type A.C. power supply and interterminal terminal board to provide connections for battery operation where it is desirable to use the unit on antenna measurements and other usages where A.C. power is not available. Compactness has been achieved without loss of performance or convenience of usage. The incorporation of the power supply, oscillator

and probe into a single unit provides a convenient device for checking all types of circuits. The indicating instrument is a standard 2 inch General Electric instrument with an easy to read scale. The calibrated dial is a large 270° drum dial which provides seven direct reading scales, plus an additional universal scale, all with the same length and readability. Each range has its individual plug-in probe completely enclosed in a contour fitting polystyrene case for assurance of permanence of calibration as well as to prevent any possibility of mechanical damage or of unintentional contact with the components of the circuit being tested.

The Grid Dip Meters may be used as:

1. A Grid Dip Oscillator
2. An Oscillating Detector
3. A Signal Generator
4. An Indicating Absorption Wavemeter

The most common usage of the Grid Dip Meter is as an oscillating frequency meter to determine the resonant frequencies of de-energized tuned circuits.

Size of Grid Dip Meter only (less probe): 7 in. x 3 3/16 in. x 3 3/8 in.

Millen Laboratory Instruments are illustrated and described in our Laboratory Equipment catalogue, a copy of which will be mailed upon request.

JAMES MILLEN

MAIN OFFICE

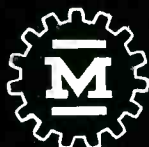

MFG. CO., INC.

AND FACTORY

MALDEN, MASSACHUSETTS, U.S.A.



CLEVELITE* and COSMALITE*

LAMINATED PHENOLIC TUBING
is used also for many other electrical products at a considerable saving where exacting specifications must be carefully followed. For the best . . . "Call Cleveland."

Those in the Radio and Television Industries know from actual use the fine performance of these Tubes.
They also know that our large production capacity assures them of a dependable source of supply with prompt delivery.



Ask us about these spirally laminated paper base phenolic tubes in diameters, wall thicknesses and lengths that will meet your needs.

* Trade Marks

The **CLEVELAND CONTAINER Co.**
6201 BARBERTON AVE. CLEVELAND 2, OHIO

PLANTS AND SALES OFFICES at Plymouth, Wisc., Chicago, Detroit, Ogdensburg, N.Y., Jamesburg, N.J.
ABRASIVE DIVISION at Cleveland, Ohio
CANADIAN PLANT: The Cleveland Container, Canada, Ltd., Prescott, Ontario

- REPRESENTATIVES**
- NEW YORK AREA R. T. MURRAY, 614 CENTRAL AVE., EAST ORANGE, N. J.
 - NEW ENGLAND R. S. PETTIGREW & CO., 968 FARMINGTON AVE. WEST HARTFORD, CONN.
 - CANADA WM. T. BARRON, EIGHTH LINE, RR #1, OAKVILLE, ONTARIO





States **HERSCHEL WOLF**
of American Airlines

"with **AMERICAN**  **AIRLINES**

EXTRA SAFETY IS A MUST..."

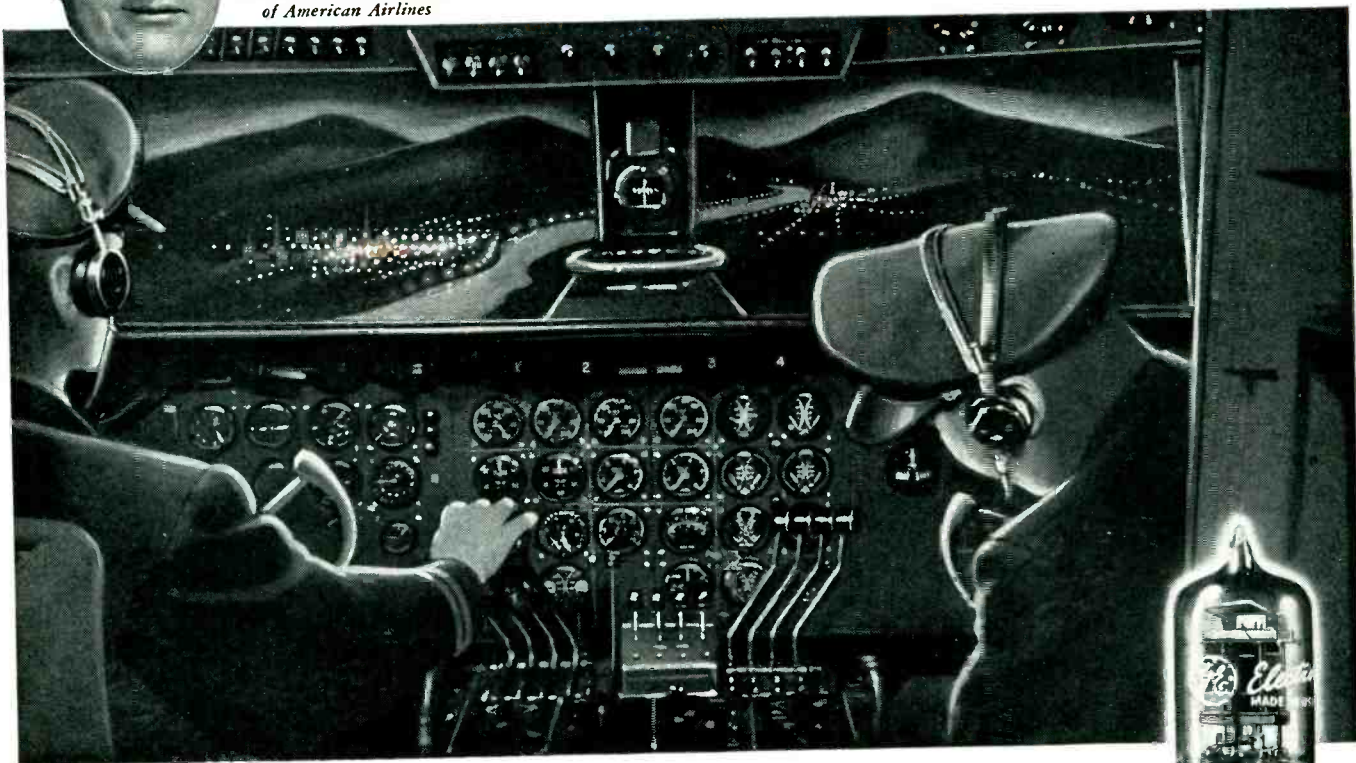

**"...G-E High-Reliability Tubes
Lift SAFETY and SAVINGS, Too!"**

SAYS Herschel Wolf, in charge of aircraft radio communications for American Airlines: "You can trust G-E High-reliability Tubes to do their job *all* the time. They've helped us lift our high safety standards still higher."

You can't beat these special G-E miniatures for steady performance "under fire"—the kind of day-in, day-out job you can count on. So take a tip from American and other enthusiastic users, and specify G-E High-reliability Tubes in the equipment now on your drawing-boards! You'll lower upkeep costs, increase safety factor, widen your product's acceptance.

Altimeters, radio compasses, radio control apparatus, h-f aircraft receivers—all are employing G-E High-reliability miniatures with marked success. Every tube gets 50 hours' service at the factory under Class A conditions. Also, frequent samples are chosen for life tests, during which the tube is operated normally but intermittently by turning the heater on and off at one-minute intervals.

Communications . . . industry . . . along with aviation, find numerous applications for G-E High-reliability miniatures—the *better* tubes for *better* service where conditions are exacting! Write for further information. Learn more about what these tubes are; what they will do; how they can serve *your* needs more efficiently.
Electronics Department, General Electric Co., Schenectady 5, N. Y.



GL-5654



GL-5670



GL-5686



- GL-5654** Sharp-cutoff r-f pentode
- GL-5670** H-f twin triode
- GL-5686** Power-amplifier pentode
- GL-5725** Semi-remote-cutoff r-f pentode
- GL-5726** Twin diode
- GL-5749** Remote-cutoff r-f pentode
- GL-5750** Pentagrid converter
- GL-5751** High-mu twin triode
- GL-5814** Medium-mu twin triode

GENERAL  **ELECTRIC**
180-36

pH Meter

CAMBRIDGE INSTRUMENT CO., INC., Grand Central Terminal, New York City. The industrial model pH Meter is a precision instrument for the determination of acidity and alkalinity of fluids, which finds wide application in medicine, science and industry.



For many years, Cambridge has used KENYON Transformers in various industrial, research, laboratory and medical instruments.

Electrocardiograph

Another example of Cambridge pioneering is the Simpli-Trol Portable Electrocardiograph-Stethograph, a diagnostic instrument used by prominent cardiologists, hospitals and medical schools throughout the world for the study of heart disease.

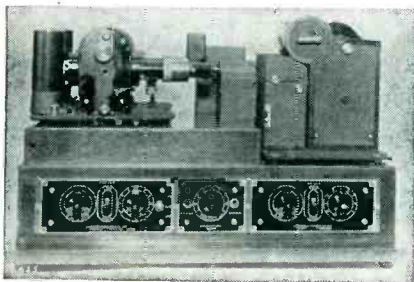

Many important developments in science and industry have been furthered by instruments designed and manufactured with KENYON Transformers by the Cambridge Instrument Co.

For over 25 years, leading manufacturers and engineers in all fields have specified KENYON Transformers for industrial, communication, sound, electronic and scientific applications. Cambridge, too, specifies KENYON Transformers for quality, dependability and sound construction!

Advertisement

Here's the "Q" in Transformers

It's **KENYON** Quality

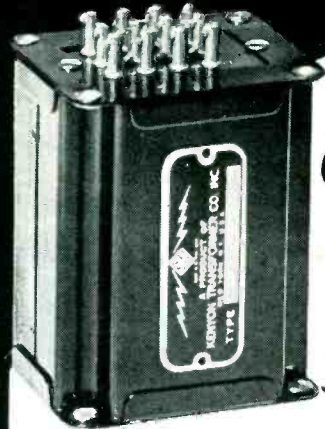

*Custom-built
to your
Specifications*

KENYON one of the oldest names in transformers, offers you high quality specification transformers custom-built to your requirements — practically at catalog prices! For over 25 years the KENYON "K" has been a sign of skillful engineering, progressive design and sound construction.

KENYON "Specials" Are Designed For:

- | | |
|----------------------|---------------------------|
| JAN APPLICATIONS | AUTOMATIC CONTROLS |
| BROADCAST | AUDIO AMPLIFIERS |
| INDUSTRIAL MACHINERY | EXPERIMENTAL LABORATORIES |
| RADAR | ATOMIC ENERGY EQUIPMENT |

Among many others

Consult our engineering staff on any of your "special" problems at no obligation to you. Call or write now for our representative.

KENYON "T's"—famous line of high quality, uniform transformers are ready for immediate delivery from stock. Our standard line can save you much time and expense. For a complete story about specific ratings on all transformers, send for your copy of the latest KENYON Catalog edition now!



KENYON TRANSFORMER CO., Inc.

840 BARRY STREET

NEW YORK 59, N. Y.

SEND FOR LATEST CATALOG NOW!

KENYON Transformer Co., Inc.

840 Barry Street, New York 59, N. Y.

Send me the latest edition of your new catalog without obligation.

Name..... Address.....

Position..... City..... Zone.....

Company..... State.....

We need "special" transformers —

Please have your representative call

electronic voltage regulators

by **sorensen**

- MAXIMUM ACCURACY
- MINIMUM DISTORTION
- FREQUENCY INSENSITIVITY



Standard DC

*Output voltage	6	12	28	48	125
**Load in amperes	5-15-40-100	5-15-50	5-10-30	15	5-10
Input voltage	95-130 VAC single phase 50-60 cycles; adapter available for 230 VAC operation				
Regulation Accuracy	±0.2% from 1/10 to full load				
Ripple voltage RMS Max.	1%				
Recovery time	0.2 seconds — value includes charging time of filter circuit for the most severe change in load or input conditions				

*Adjustable +10%, -25%
 **Individual models identified by indicating output voltage first then amperes. Example: E-6-5 6 VDC @ 5 amperes



Standard AC

Model in VA Capacity	150S	250S	2000S	5000S
	500S	1000S	3000S	10000S
Regulation Accuracy	±0.1%	0.1%	0.1%	0.1%
Harmonic Distortion	3% max.	2% max.	3% max.	3% max.
Input voltage	95-130 VAC also available for 190-260 VAC single phase 50-60 cycles			
Output voltage	Adjustable between 110-120; 220-240 in 230 VAC models			
Load range	0 — Full load			
P.F. range	Down to 0.7 P.F.			

NOTES: Regulators can be hermetically sealed.
 All models temperature compensated.

SPECIALS Your particular requirements can be met by employing the ORIGINAL SORENSEN CIRCUIT in your product or application.

SORENSEN REGULATORS can be designed to meet JAN specifications.

SORENSEN engineers are always available for consultation about unusual regulators to meet special needs not handled by THE STANDARD SORENSEN LINE.

Write for Complete Literature

Sorensen and company, inc.

375 Fairfield Avenue, Stamford, Conn.

PRODUCED FOR YOUR REQUIREMENTS
- by the top specialists in the ceramic field

Hi-Q

CERAMIC PLATE CAPACITORS

Essentially similar, except in shape, to Hi-Q Disk Capacitors except that in the multiple units they do NOT have to have a common ground as is the case with disks. These Hi-Q Plates can be produced in an unlimited range of capacities, the number on a plate being limited only by the K of the material and the physical size of the unit. They offer the greatest available capacity per unit volume of any type condenser on the market.

Guaranteed minimum values of capacity up to 33,000 mmf per sq. in. are available. This is based on the use of Body 41 ceramic having 3000 as a dielectric constant "K" and .020 in. thickness and the formula:

$$C \text{ (mmf)} = \frac{.224 K A \text{ (Sq. in.)}}{D \text{ in.}}$$

If temperature compensating ceramics are used, the capacity will be considerably lower. Typical circuits are shown here, but almost any combination can be produced for your specific needs. Consult our engineers for complete details. Write for new Hi-Q datalog.

PC-100

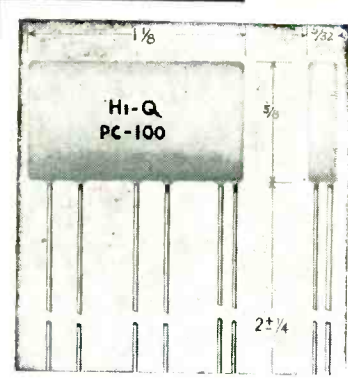

1-2	.002	+ 75%	- 25%	mf
3-4	220	+ 50%	- 50%	mmf
4-5	220	+ 50%	- 50%	mmf
5-6	.005	+ 75%	- 25%	mf

PC-101



1-2	.002	+ 75%	- 25%	mf
2-3	100	+ 50%	- 50%	mmf
3-4	.005	+ 75%	- 25%	mf
4-5	150	+ 50%	- 50%	mmf
5-6	.005	+ 75%	- 25%	mf

PC-102

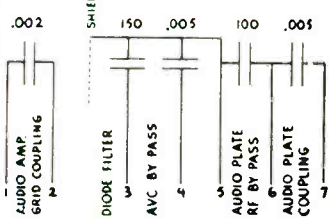

1-2	.002	+ 75%	- 25%	mf
3-5	150	+ 100%	- 0%	mmf
4-5	.005	+ 100%	- 0%	mf
5-6	100	+ 75%	- 25%	mmf
6-7	.005	+ 75%	- 25%	mf

PC-103

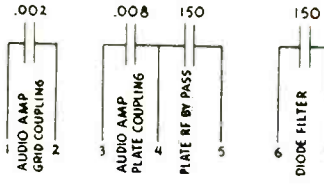

1-2	.002	+ 75%	- 25%	mf
3-4	.008	Min	%	mf
4-5	150	+ 50%	- 50%	mmf
6-7	150	+ 50%	- 50%	mmf

PC-104

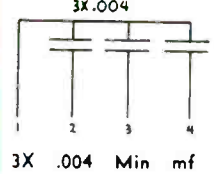

3X .004 Min mf

PC-105

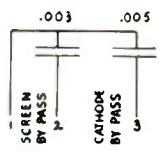

1-2	.003	+ 75%	- 25%	mf
1-3	.005	+ 75%	- 25%	mf

PC-107

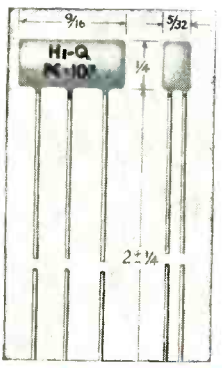

1-2	150	+ 75%	- 25%	mmf
1-3	500	+ 75%	- 25%	mmf

Hi-Q COMPONENTS

Capacitors
 Trimmers • Choke Coils
 Wire Wound Resistors

BETTER 4 WAYS

- ✓ PRECISION
- ✓ UNIFORMITY
- ✓ DEPENDABILITY
- ✓ MINIATURIZATION

JOBBERs — ADDRESS: 740 Belleville Ave., New Bedford, Mass.

Hi-Q

Electrical Reactance Corp.

OLEAN, N. Y.

SALES OFFICES: New York, Philadelphia
 Detroit, Chicago, Los Angeles

PLANTS: Olean, N. Y., Franklinville, N. Y.
 Jessup, Pa., Myrtle Beach, S. C.

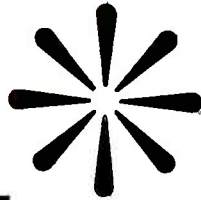

Products bearing the registered trademark "**dag**" originate only with the Acheson Colloids Corporation, Port Huron, Michigan, or with Acheson Colloids Ltd., London, England. Acheson Colloids is the world's largest producer of colloidal graphite dispersions for the metalworking and electronic industries, and also supplies dispersed pigments to a large segment of the color-consuming trade. The trademarks "Oildag", "Aquadag", "Prodag", "Glydag", "Castordag", "Varnodag" and "Gredag" identify particular products of Acheson Colloids Corporation or its affiliates, and are duly registered in the United States and in other principal countries of the world.



Acheson Colloids Corporation, Port Huron, Michigan
... also Acheson Colloids Limited, London, England

QUICK, RELIABLE

impedance measurements up to 500 megacycles

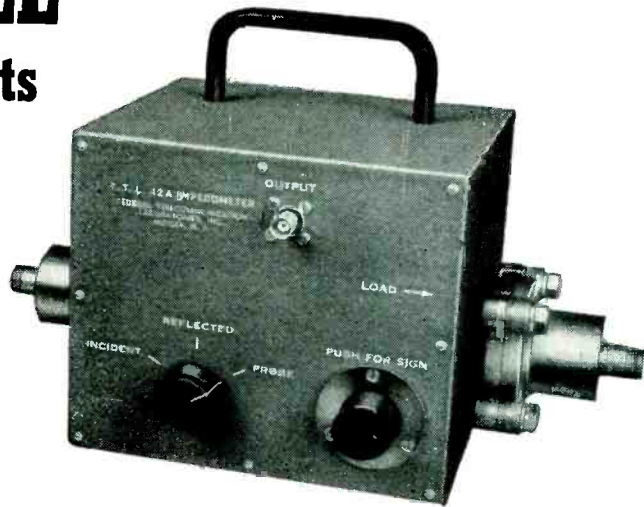

FTL-42A IMPEDOMETER

Any signal generator with 0.1 volt maximum into 51.5 ohms output furnishes sufficient power for operation.

Crystal detector and audio amplifier with output meter have sufficient sensitivity as a detector above 100 megacycles.

Compact, simple, accurate instrument for the measurement of impedance, attenuation, reflection coefficient and standing-wave ratio at frequencies up to 500 megacycles.

Read relative voltages of incident wave, reflected wave and resultant. Plot diagram of voltages on Smith Chart and impedance can be determined to $\pm 5\%$.

Requires no unusual accessories — only those found in every laboratory and test shop working in the frequency range of the instrument: signal generator with 0.1 volt maximum output, crystal detector, audio amplifier, and output meter. Below 100 megacycles a radio receiver is desirable for its greater sensitivity.

In addition, the FTL-42A Impedometer can be operated with input power up to several hundred watts when it is desired to drive the load in this manner.

Adapters for $1\frac{1}{8}$ inch line to type N are furnished so that the instrument can be used with flexible cables.

The FTL-42A Impedometer can be used directly with $1\frac{1}{8}$ inch line, or with other sizes of lines or cables by use of various adapters that are available.

It can be built for other impedances such as 72 ohms coaxial, according to requirements of user.

Dimensions of cabinet: $6\frac{1}{16}$ inches long by $5\frac{1}{16}$ inches wide by $5\frac{7}{8}$ inches high. Net weight including adapters is 7 pounds.

Price — \$400.00

Write for complete FTL-42A brochure.



Federal Telecommunication Laboratories, Inc.

500 Washington Avenue

Nutley 10, New Jersey



**A NEW SERVICE TO TV
MANUFACTURERS**

**A NEW MARKET FOR TV
SERVICEMEN**

with General Electric TV Components

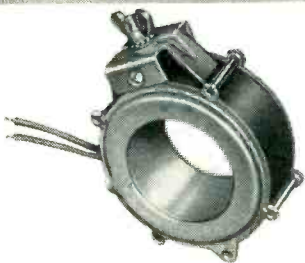

EM-PM FOCUS COIL—These units combine the effects of Alnico 6 permanent magnet and an electromagnet to provide uniform focus with a minimum of circuit power.

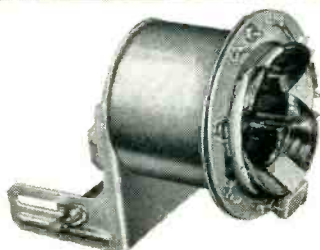

NEW DEFLECTION YOKE—Sweeps 70° with only 20 watts of power from a 260-volt supply. Ferrite core units available for high efficiency applications.

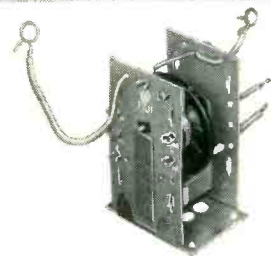

HORIZONTAL SWEEP TRANSFORMER—When used with high efficiency yokes, these ferrite core transformers provide 70° deflection at 13 kv.

You can put your confidence in—

GENERAL  ELECTRIC . .

RECEIVER MANUFACTURERS

You can cut replacement parts servicing problems to a minimum...keep your sets in the field with the assurance of ready serviceability . . . reduce material and handling costs...by designing General Electric TV components into your product.

More than twenty TV receiver manufacturers are now using G-E components. Big makers like them because they're expertly fabricated, dependable, backed by a name you can depend on.

Smaller manufacturers turn to G.E. for components specially adapted to fit particular designs. Remember—when you use G-E parts, duplicates are stocked by G-E distributors and dealers everywhere—automatic assurance that your sets will be repaired in the field, not returned to the factory.

SERVICEMEN

Estimates peg the TV market at ten million sets in use by the end of 1950...*that's your opportunity!*

Millions of G-E parts are now in receivers everywhere...and more manufacturers are turning to General Electric every day...Be sure you get your share of the skyrocketing replacement business that supports these receiver sales...*that's your market!*

Now—for the first time—dealers and servicemen can stock the complete line of General Electric components shown here! They're available through parts jobbers and distributors in your area.

Put yourself in the replacement business for keeps—and for profit. Call your jobber or distributor for full details. Meanwhile, send for the complete G-E Parts Catalog, just off the press. Mail the coupon and the catalog will be rushed to you—free!

WIDTH & LINEARITY CONTROLS—
Provide convenient control of picture and linearity by screwdriver adjustment.

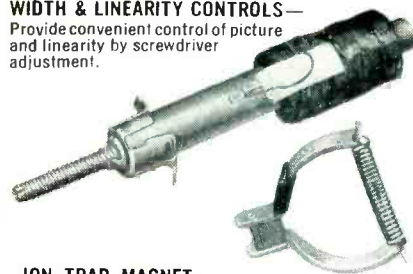

ION TRAP MAGNET—
Available in two sizes, 35 and 42 gauss.

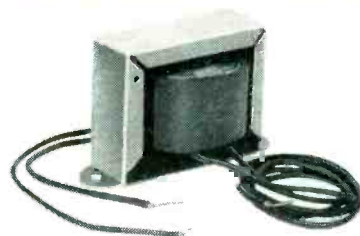

VERTICAL SWEEP TRANSFORMER—For use in magnetic deflection circuits from 50°-70°. Designed to match vertical output tube to deflection yoke.

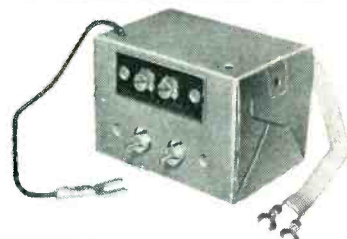

FM WAVE TRAP—Reduces or eliminates interference caused by FM broadcasting stations operating in 88 to 108 mc channels.



IF WAVE TRAP—Designed to reduce or eliminate interference on TV receivers caused by signals at IF frequencies of 41-47 mc.

**ARE YOU READY?
MAIL THIS COUPON TODAY!**

General Electric Company, Section 4100,
Electronics Park, Syracuse, N. Y.

I want my share of the new TV replacement market. Send me complete catalog of TV components and facts on service sales.

NAME _____

ADDRESS _____

CITY _____

STATE _____

Miniaturization Specialist Capacitors—

1000 to the Pound!

AEROVOX MICRO-MINIATURES

(TYPE P83Z AEROLITE® CAPACITORS)

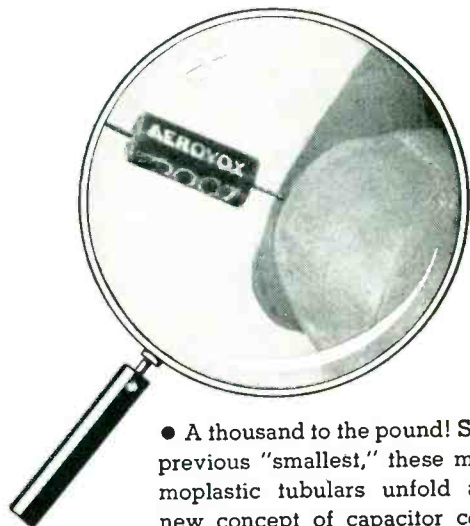

● A thousand to the pound! Smaller than previous "smallest," these molded thermoplastic tubulars unfold an entirely new concept of capacitor construction.

The smaller physical sizes are directly attributed to the latest metallized-paper technique which combines both dielectric and electrodes in a single winding strip. Unusually strong lead connections to capacitor section. Since capacitance is predetermined mechanically in the initial processing, it is no longer necessary to rely on the human element for capacitance control.

Type P83Z Micro-miniatures are particularly applicable to that portion of the electronic field where low capacitance paper capacitors and high-capacity disk capacitors are now being used.

●Trade-mark

Featuring . . .

Two sizes: 3/16" d. x 7/16" l.; 1/4" d. x 9/16" l.
200, 400 and 600 rated voltage; 300, 600 and 900 test voltage.
Hvovl K impregnated in humidity-resistant molded thermoplastic case.
Operating temperature from -15°C. to +85°C. without derating.
Power factor less than 1% when measured at or referred to frequency of 1000 cps and ambient temperature of 25°C.
Life test: 1000 hours at 1.25 times rated voltage in ambient temperature at 85°C.
Insulation resistance of 25,000 megohms or greater, measured at or referred to temperature of 25°C. Insulation resistance at 85°C., 500 megohms or greater.



● Try Aerovox Micro-miniatures in your miniaturized assemblies. Write Dept. MM-83 for engineering data, samples, quotations and application-engineering aid.



FOR RADIO-ELECTRONIC AND INDUSTRIAL APPLICATIONS

AEROVOX CORPORATION, NEW BEDFORD, MASS., U. S. A.

Sales Offices in All Principal Cities • Export: 41 E. 42nd St., New York 17, N. Y.

Cable: AEROCAP, N. Y. • In Canada: AEROVOX CANADA LTD., Hamilton, Ont.

The Way Up!

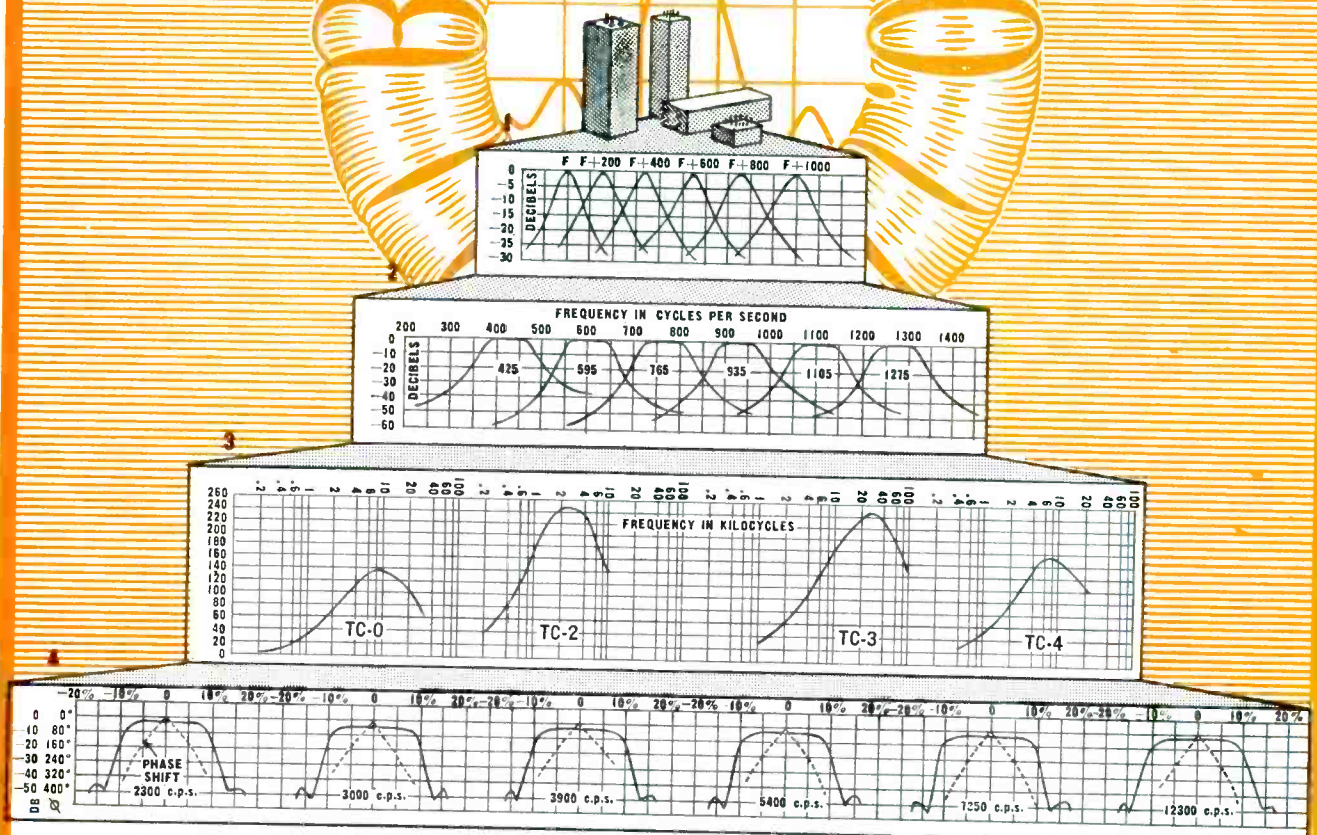

1 SUB-MINIATURE "GUIDED MISSILES" FILTERS

For security reasons details of this development in miniaturization must be omitted. It can be told, however, that all six channels are contained in a total volume of 18 cubic inches or 3 cubic inches per channel.

2 TONE CHANNEL FILTERS *

Available for either 170 or 340 cycles spacing between channels. These filters have received wide acceptance and are extremely popular among manufacturers of carrier telegraph equipment. In addition to the many standard types of tone filters we are supplying, special characteristics can readily be incorporated into designs to suit your application.

3 HIGH Q TOROIDAL COILS

"Actually the first essential requirement in the design and manufacture of high quality audio filters, these toroids wound on molybdenum permalloy cores have provided the almost impossible solution for many network problems. As the leading independent manufacturer of toroids, our products are backed by years of experience and specialized knowledge."

4 TELEMETERING FILTERS *

Among the earliest to be employed in the improved telemetering system now in general use. Particular attention has been paid to linearity of phase shift and good transient suppression as well as high inter-channel attenuation in order to eliminate distortion in telemetering reception.

*"Filters such as these are included in a wide variety of types which we are now producing for manufacturers and users of microwave communications and relay equipment. We would be pleased to discuss your application for filters in this field and bring you up to date on the latest developments in the application and design of filters which have resulted from our close association with the carrier communications industry."

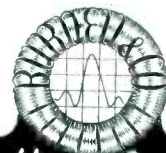

Burnell & Company

YONKERS 2, NEW YORK

CABLE ADDRESS "BURNELL"

Exclusive Manufacturers of Communications Network Components

Announcing

the **H-14**

SIGNAL GENERATOR

108-118 megacycles

Newest in ARC's Line of Signal Generators



Checks on...

- 24 Omni courses
- Left-center-right on Phase-localizer
- Left-center-right on Amplitude-localizer
- Omni course sensitivity
- To-From and Flag-alarm operation
- All necessary quantitative bench tests



Use the H-14 for Testing Omni

Receiving Units in Aircraft

..... or on the Bench.

The Type H-14 Signal Generator, 108-118 megacycles provides a standard signal source for the complete testing of VHF airborne omnirange and localizer receivers in aircraft or on the bench. It provides for testing 24 omni courses, plus left-center-right checks on both amplitude and phase localizers. Aircraft may be checked out quickly and accurately just before take-off. RF output for ramp checks, 1 volt into 52 ohm line and for bench checks, 0-10,000 microvolts. Provision for external voice or other modulation. AF output available for bench maintenance and trouble shooting.

PRICE: \$885.00 net, f.o.b. Boonton, N. J.



Aircraft Radio Corporation

Boonton, N. J.

Dependable Electronic Equipment Since 1928

MICROWAVE TEST SET ... TYPE

H-10

23,500-24,500 MEGACYCLES

Provides source of cw or pulse frequency-modulated RF, power level -37 to -90 dbm. RF power meter measures levels from +7 to +30 dbm. Frequency meter for measuring output or input RF accurate to better than 20 mc. Primary purpose of the H-10 is to measure receiver sensitivity, bandwidth, frequency, recovery time, and overload characteristics, plus transmitter power and frequency. Recommended as a standard source of RF for research or production testing. Equal to military TS-223/AP.

PRICE: \$1692.00 net, f.o.b. Boonton, N. J.



UHF SIGNAL GENERATOR ... TYPE

H-12

900-2100 MEGACYCLES

Provides source of cw or pulse amplitude-modulated RF, power level 0 to -120 dbm. Internal pulse circuits with controls for width, delay, and rate, and provision for external pulsing. Single dial tuning, frequency calibration accurate to better than 1%. Built to Navy specifications for research and production testing. Equal to military TS-419/U.

PRICE: \$1950.00 net, f.o.b. Boonton, N. J.



ARC COMMUNICATION AND NAVIGATION EQUIPMENT

Aircraft Radio Corporation also manufactures LF and VHF airborne communication and navigation equipments - all CAA-Type-Certificated for scheduled air-carrier use or for those whose type of flying requires a high degree of reliability and performance. Equipment consists

of light, small units which can be combined to provide the required operation, whether it be the 1 Receiver/1 Transmitter (15-pound) installation in a 2-place helicopter, or a 3 Receiver/2 Transmitter/VHF Omni installation (70 pounds) in larger 2-engine aircraft.

WRITE TODAY for descriptive bulletins on any of these instruments

Only
One



In medieval times, a coat-of-arms had an importance that could not be overestimated. It was granted as a personal badge, signifying the attributes and accomplishments of its proprietor—and as such was respected thruout the civilized world. It had no duplicate.

In turn, the emblem imposed upon its owner a responsibility for maintaining an enviable reputation—a condition which stimulated general confidence in him.

Times have changed, but not all things. The sense of sanctity of an emblem is prevalent today as

it was hundreds of years ago. That is why we take such pride in our trademark: NICHROME.

It is evidence of our accomplishment; our unique, personal badge — respected everywhere. Granted solely and wholly to us by the United States Patent Office over forty years ago, it symbolizes a series of superb electrical heat and corrosion-resistant alloys (developed and produced *only* by Driver-Harris Company) which today is serving industry all over the world.

Yes, there are other excellent heat and corrosion-resistant alloys, but *only one* NICHROME—the product of exclusive Driver-Harris knowledge and techniques.

We are well aware of our obligation to maintain its reputation, both here and abroad. In fact, such obligation is an inspiration to give of our best—now, tomorrow, and always.



Nichrome* is manufactured only by

Driver-Harris Company
HARRISON, NEW JERSEY

BRANCHES: Chicago, Detroit, Cleveland, Los Angeles, San Francisco,
Manufactured and sold in Canada by
The B. GREENING WIRE COMPANY, LTD., Hamilton, Ontario, Canada

*T.M. Registered in United States Patent Office by Driver-Harris Company August, 1908

12 Improvements IN NEW 1951

MODEL O-6

PUSH-PULL

Heathkit OSCILLOSCOPE KIT

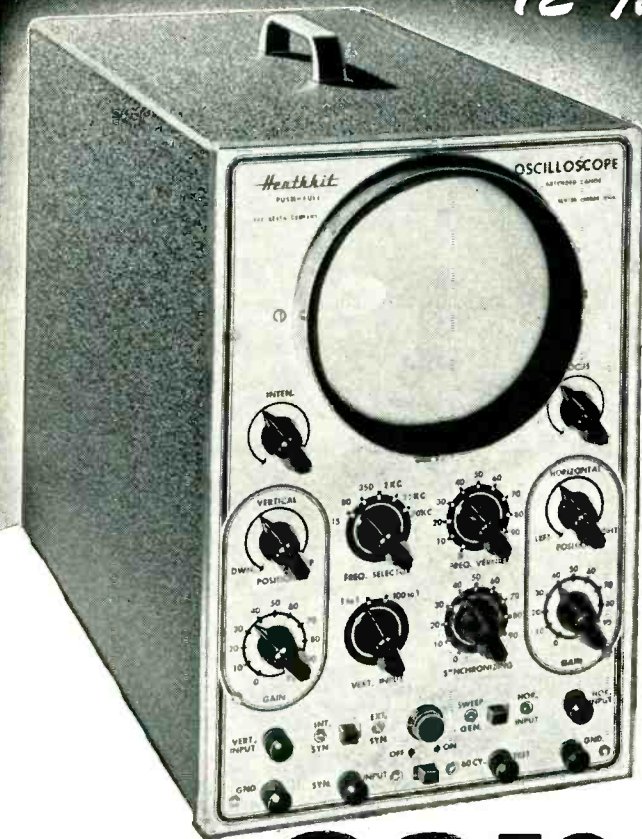

Only **\$39.50**

- ★ New AC and DC push-pull amplifier.
- ★ New step attenuator frequency compensated input.
- ★ New non frequency discriminating input control.
- ★ New heavy duty power transformer has 68% less magnetic field.
- ★ New filter condenser has separate vertical and horizontal sections.
- ★ New intensity circuit gives greater brilliance.
- ★ Improved amplifiers for better response useful to 2 megacycles.
- ★ High gain amplifiers .04 Volts RMS per inch deflection.
- ★ Improved Allegheny Ludlum magnetic metal CR tube shield.
- ★ New synchronization circuit works with either positive or negative peaks of signal.
- ★ New extended range sweep circuit 15 cycles to over 100,000 cycles.
- ★ Both vertical and horizontal amplifier use push-pull pentodes for maximum gain.

New INEXPENSIVE MODEL S-2 ELECTRONIC SWITCH KIT

Twice as much fun with your oscilloscope — observe two traces at once — see both the input and output traces of an amplifier, and amazingly you can control the size and position of each trace separately — superimpose them for comparison or separate for observation — no connections inside scope. All operation electronic, nothing mechanical — ideal for classroom demonstrations — checking for intermittents, etc. Distortion, phase shift and other defects show up instantly. Can be used with any type or make of oscilloscope. So inexpensive you can't afford to be without one.

Has individual gain controls, positioning control and coarse and fine switching rate controls — can also be used as square wave generator over limited range. 110 Volt transformer operated comes complete with tubes, cabinet and all parts. Occupies very little space beside the scope. Better get one. You'll enjoy it immensely. Model S-2. Shipping Wt., 11 lbs.



Only **\$19.50**

The new 1951 Heathkit Push-Pull Oscilloscope Kit is again the best buy. No other kit offers half the features — check them.

Measure either AC or DC on this new scope — the first oscilloscope under \$100.00 with a DC amplifier

The vertical amplifier has frequency compensated step attenuator input into a cathode follower stage. The gain control is of the non frequency discriminating type — accurate response at any setting. A push-pull pentode stage feeds the C.R. tube. New type positioning control has wide range for observing any portion of the trace.

The horizontal amplifiers are direct coupled to the C.R. tube and may be used as either AC or DC amplifiers. Separate binding posts are provided for AC or DC.

The multivibrator type sweep generator has new frequency compensation for the high range it covers; 15 cycles to cover 100,000 cycles.

The new model O-6 Scope uses 10 tubes in all — several more than any other. Only Heathkit Scopes have all the features.

New husky heavy duty power transformer has 50% more laminations. It runs cool and has the lowest possible magnetic field. A complete electrostatic shield covers primary and other necessary windings and has lead brought out for proper grounding.

The new filter condenser has separate filters for the vertical and horizontal screen grids and prevents interaction between them.

An improved intensity circuit provides almost double previous brilliance and better intensity modulation.

A new synchronization circuit allows the trace to be synchronized with either the positive or negative pulse, an important feature in observing the complex pulses encountered in television servicing.

The magnetic alloy shield supplied for the C.R. tube is of new design and uses a special metal developed by Allegheny Ludlum for such applications.

The Heathkit scope cabinet is of aluminum alloy for lightness of portability.

The kit is complete, all tubes, cabinet, transformer, controls, grid screen, tube shield, etc. The instruction manual has complete step-by-step assembly and pictorials of every section. Compare it with all others and you will buy a Heathkit. Model O-6. Shipping Wt., 30 lbs.

EXPORT DEPT.
13 East 40th St.
NEW YORK CITY (16)
CABLE: ARLAB-N.Y.

The **HEATH COMPANY**

... BENTON HARBOR 14, MICHIGAN

HOW TO STOP TROUBLE BEFORE IT STARTS!

It's no accident that AISiMag components give you the plus performance and the smooth assembly that they should. It's planned that way.



Every new design goes through two groups of engineers at the AISiMag plant. The first group studies the design to see if it can be made to do its job more effectively or if it can be modified for more efficient production.

Production engineers in the second group study the design to adapt it to the most efficient production methods in our plant. On complex designs, both groups study the prints, then get together for final discussions. Thus the men who are directly responsible for production see the design before the order is accepted. They point out any design features that might lead to trouble or unnecessary expense.



These engineering recommendations are sent to the customer. Specialized experience and intimate

knowledge of available production methods thus give you better AISiMag components at a saving.

In many instances, our engineering groups recommend hand made test samples of the original design and of modified designs. These can be made promptly and at reasonable cost. Once the proper design is found, production orders can be entered with assurance that the design does the job and that it is practical to produce.

When production orders are entered, Quality Control takes over. If the job gets off specification at any point, the trouble is corrected immediately. This saves a lot of time and a lot of money and helps us make delivery as promised. And it assures that your AISiMag parts will fully meet all specifications.

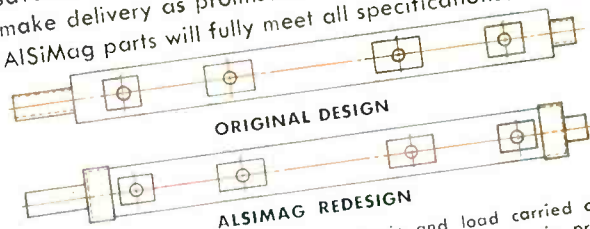

Weak points removed from the ceramic and load carried on metal caps. Overall strength greatly increased. Losses in production and in use greatly reduced. Precision manufacture at minimum cost obtained through redesign.

ALSIMAG®

49TH YEAR OF CERAMIC LEADERSHIP
AMERICAN LAVA CORPORATION
 CHATTANOOGA 5, TENNESSEE

OFFICES: METROPOLITAN AREA, 671 Broad St., Newark, N. J., Mitchell 2-8159 • CHICAGO, 228 North LaSalle St., Central 6-1721
 PHILADELPHIA, 1649 North Broad St., Stevenson 4-2823 • LOS ANGELES, 232 South Hill St., Mutual 9076
 NEW ENGLAND, 38-B Brattle St., Cambridge, Mass., Kirkland 7-4498 • ST. LOUIS, 1123 Washington Ave., Garfield 4959

"AISiMag engineers have always had the answer to our ceramic problems."

"AISiMag is always right on the specifications."

"AISiMag delivers as promised and gives us parts that do the job."

"In nearly every case AISiMag engineers have helped us work out a better component that costs us less money."

"AISiMag cannot always give us the delivery date we want but they have always delivered as promised."

"AISiMag is the only one that has always met our tolerance requirements."



the
best
picture
in
Television
is...

CLAROSTAT

**FOR CONTROLS,
RESISTORS, BEAM-BENDERS**

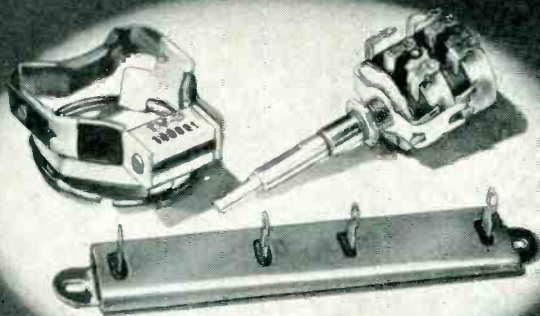

As "Big Business," television came suddenly. Just as suddenly, Clarostat was ready. Three decades of pioneering and specialization, backed by a plant second to none, assured TV designers and manufacturers of an outstanding selection of resistors, controls and resistance devices.

And when ion spot blemishes became a major problem, again Clarostat was ready with simpler and cheaper beam-benders.

Thus Clarostat products are already represented in over 5,000,000 sets and in countless radios in daily use. All because, for quality, uniformity, dependability, economy, it's CLAROSTAT.

WRITE FOR Engineering Bulletins on resistors, controls and resistance devices. Let us collaborate on your control and resistance problems and requirements.

Controls and Resistors

CLAROSTAT MFG. CO., INC. • DOVER, NEW HAMPSHIRE
IN CANADA: CANADIAN MARCONI CO. LTD., MONTREAL, P. Q., AND BRANCHES

CLAROSTAT



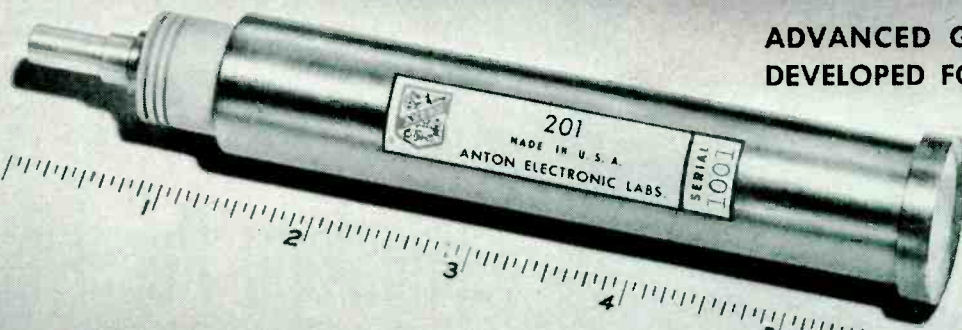

ADVANCED G-M COUNTER DEVELOPED FOR U.S. NAVY



ANTON

TYPE 201—U. S. NAVY TYPE BS-1.

High sensitivity end mica window counter for β , γ , and high energy α detection. Specifically designed for precision survey instruments.

ADVANCED ELECTRONICS

ANTON LABORATORIES is a complete, self-contained electronic establishment in which the advanced designs of skilled technicians are converted into a wide range of outstanding instruments and components for measurement and generation of radiation—equipment that has won the acclaim of users in research laboratories, schools, hospitals, and the acceptance of manufacturers and the Armed Forces.

Located in the center of research activity, in New York City, cooperating with eminent scientists in many fields, the ANTON Laboratories provide completely integrated facilities for research and production. We design what we make—and make what we design—all under one roof and one management. We do an outstanding job, because we do all of the job.

Most recently, our work in cooperation with the U.S. Navy and the Naval Research Laboratories has resulted in the development of Counter Tubes of greatly improved sensitivity, performance and dependability. These are now available to laboratories and manufacturers of quality instruments.

Complete Tube Catalog, containing detailed specifications and technical data, is available upon request.

IMPROVED COUNTER TUBES

Anton Tubes are the product of years of intensive research effort—employing new methods in design and manufacturing, improved materials, precision workmanship, and controlled production techniques.

● GROOVED CERAMIC INSULATORS

A basic improvement over conventional flame-worked glass bulb: Precision molded . . . uniform diameter . . . accurate alignment . . . mechanically stronger. Deep grooves lengthen surface path to minimize external leakage. No bulge around cathode to interfere with probe assembly or restrict "stacking" . . . no wax coating to be scratched . . . and non-photosensitive.

● HALOGEN QUENCHED

Uniform, stable characteristics unaffected by use . . . cannot be damaged by sustained over-voltage . . . operating range -55°C to $+75^{\circ}\text{C}$. . . long shelf life . . . large pulse amplitude.

● MECHANICAL DESIGN

Mechanically rugged, capable of withstanding shock and vibration . . . designed for convenient incorporation in instruments . . . exhaust tip protected by screwed-on terminal cap.

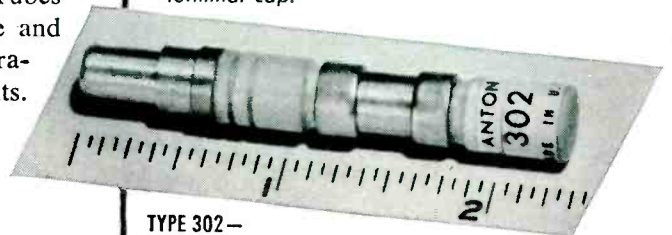

TYPE 302—

U. S. NAVY TYPE BS-2. Low sensitivity gamma counter, extremely short dead time— for precision high intensity measurements.

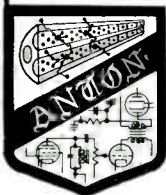

ANTON ELECTRONIC LABORATORIES, INC.

1226-1230 FLUSHING AVE., BROOKLYN 6, N. Y.

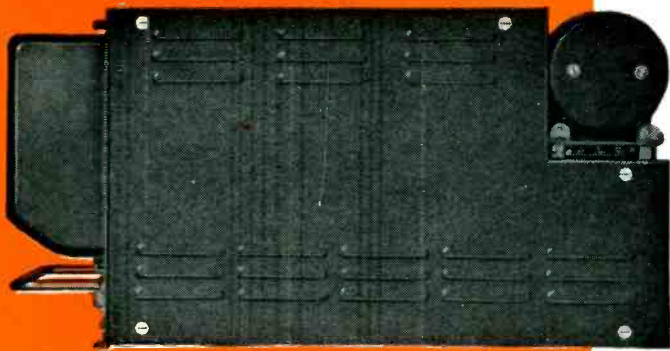

51V-1 glideslope receiver, covers in place

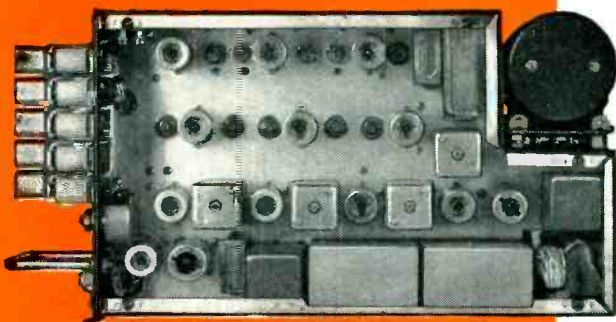

Collins 51V-1 chassis (right side)

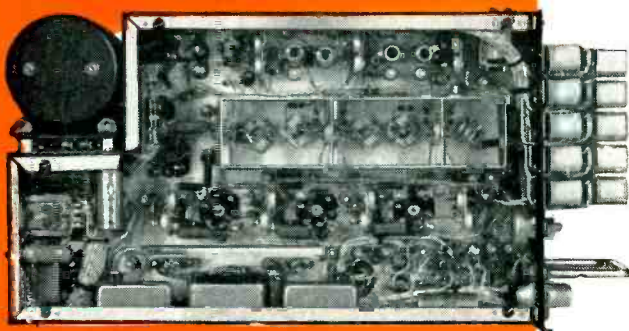

Collins 51V-1 chassis (left side)

Glideslope Receiver

51V-1

...inside and out

THIS is the new Collins 51V-1 glideslope receiver for aircraft. Note the orderly design, and the accessibility of all tubes, components, and wiring.

The 51V-1 provides reception of 90/150 cps tone modulated glideslope signals on any of the twenty channels in the uhf range of 329-335 mc. This receiver together with Collins 51R navigation equipment will fulfill ILS receiving requirements for military, commercial and private aircraft. The design of the 51V-1 is based on "Glideslope Receiver Characteristics" issued by Aeronautical Radio, Inc., and on U. S. Airforce specifications.

Output circuits of the 51V-1 receiver feed standard ID-48ARN deviation indicators including flag alarm. By means of the flag alarm the pilot has a positive indication of the reliability of the glideslope signals and instrumentation.

The 51V-1 control circuits are integrated with the standardized R/θ channeling system with channel selection provided by means of a Collins 314U remote control unit.

More complete information, in the form of an illustrated bulletin, is yours on request.

IN AVIATION RADIO, IT'S...



COLLINS RADIO COMPANY, Cedar Rapids, Iowa

11 West 42nd Street, New York 18, N. Y.

2700 West Olive Ave., Burbank, Calif.

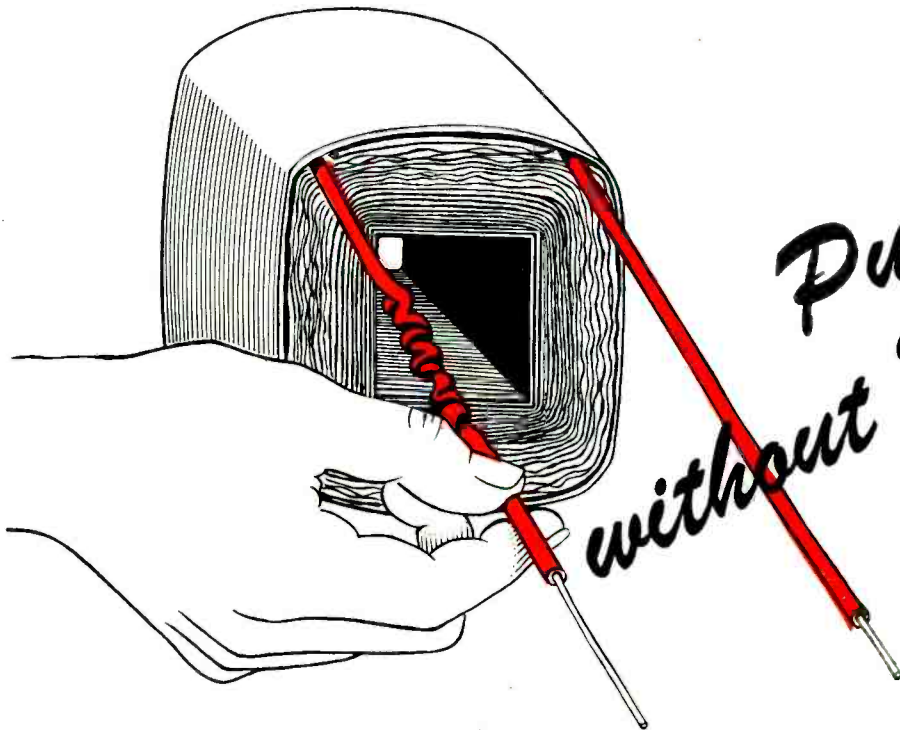

*Push-back
without "Breakdown"*

New Tough Insulation Speeds Coil Production

In coil manufacture, the amazing flexibility of BH "649" Fiberglas Tubing and Sleeving permits ease of push-back with no loss of physical or dielectric properties. Saves valuable production time. Cuts down rejects. BH "649" can be twisted, compressed, folded — with no cracking or rupture of the film.

BH "649" has a smooth bore, handles easily during production with no snagging. Will not support combustion. Resists moisture,

oils, grease or ordinary chemicals. Remains supple after baking at 302°F. for 24 hours. Unaffected at temperatures as low as -67°F. Suitable for use with most impregnants—for complete test data, see our Technical Data Folder. BH "649" is made in Grades A-1, B-1, C-1 and C-2—in all sizes from No. 24 to 5/8" inclusive. Write for production samples.

BENTLEY, HARRIS MANUFACTURING COMPANY
CONSHOHOCKEN, PA.

BH *Fiberglas** SLEEVINGS

—USE COUPON NOW—

Bentley, Harris Mfg. Co., Dept. E-42, Conshohocken, Pa.

I am interested in BH "649" Fiberglas Tubing and Sleeving. Send samples for production testing of Grade _____ in sizes as follows _____ for _____ operating at temperatures of _____ °F. at _____ volts.
(size or I.D.) (product)

NAME _____

ADDRESS _____

Send samples, pamphlets and prices on other BH Products as follows:

- BH non-fraying Fiberglas Sleeving
- Cotton or Rayon-base Sleeving and Tubing

MYCALEX

MINIATURE TUBE SOCKETS

7-PIN and 9-PIN...and SUBMINIATURES

*Premium Insulation
Priced Competitively*

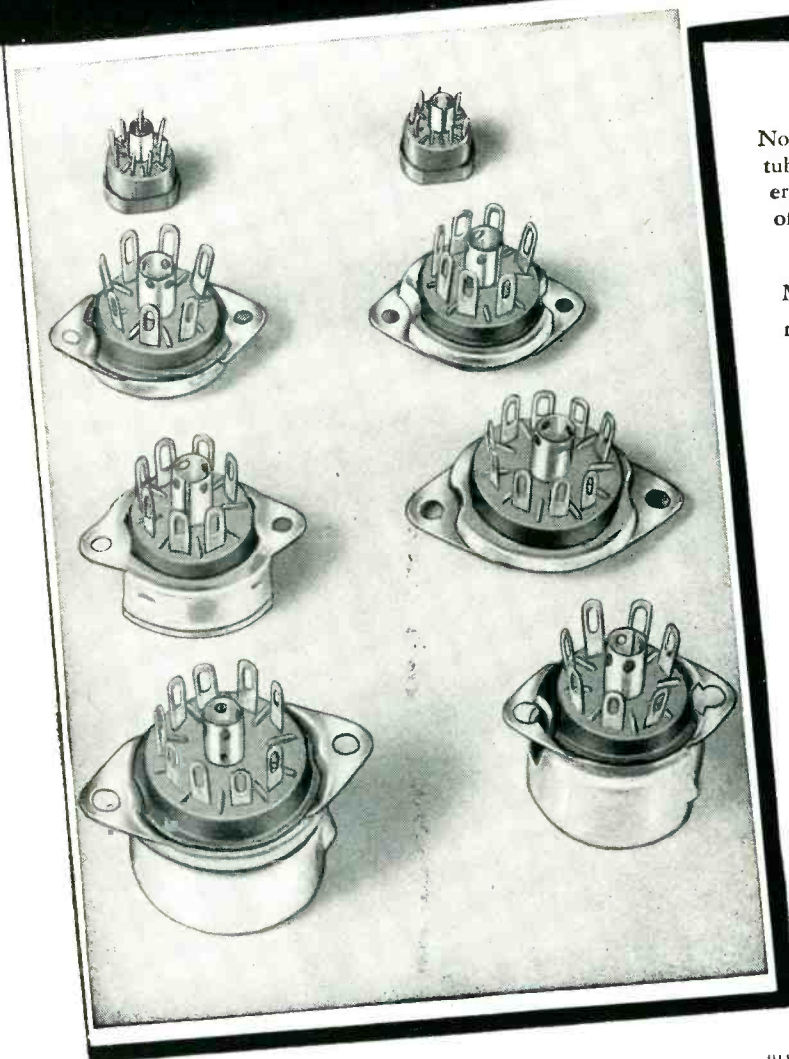

Now MYCALEX offers both 7-pin and 9-pin miniature tube sockets . . . with superior low loss insulating properties, at prices that offer ceramic quality for the cost of phenolics.

MYCALEX miniature tube sockets are injection molded with precision that affords uniformity and extremely close tolerances. MYCALEX insulation has high dielectric strength, very low dielectric loss, high arc resistance and great dimensional stability.

Produced in two grades: MYCALEX 410 conforms to Grade L4 specifications, having a loss factor of only .015 at 1 MC. It is priced comparably with mica filled phenolics.

MYCALEX 410X is for applications where low cost of parts is vital. It has a loss factor only one fourth that of "everyday" quality insulating materials, and a cost no greater.

Prices gladly quoted on your specific requirements. Samples and data sheets by return mail. Our engineers will cooperate in solving your problems of design and cost.

Mycalex Tube Socket Corporation

"Under Exclusive License of Mycalex Corporation of America"
30 Rockefeller Plaza, New York 20, N. Y.



MYCALEX CORP. OF AMERICA

"Owners of 'MYCALEX' Patents"

Executive Offices: 30 Rockefeller Plaza, New York 20, N. Y.

Plant and General Offices: Clifton, N. J.

Airborne Instruments Laboratory Specifies

CLARE SEALED **RELAYS**

**For Aircraft, Ship and
Submarine Control Equipment**

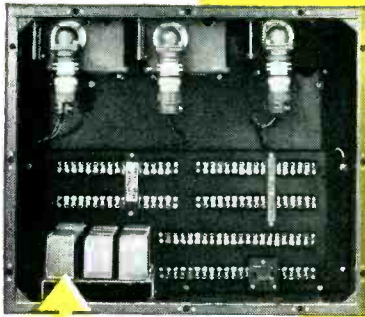

Front view of Airborne Instruments Laboratory control panel, with cover removed, showing group of eight CLARE hermetically sealed relays which perform important circuit control functions.

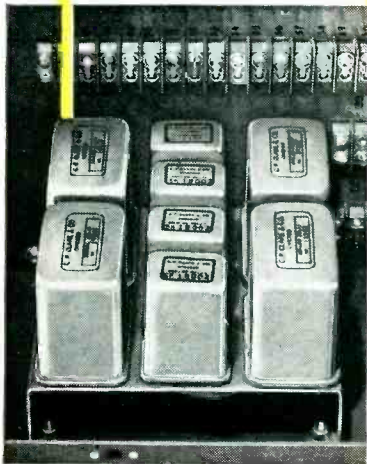

Cutaway view of typical CLARE Type "K" d-c Relay which is hermetically sealed in a permanent atmosphere of dry, inert gas to give maximum performance under the most extreme conditions of dust, moisture, air pressure and combustible gases.

Close-up view of the CLARE relay installation which demonstrates the economical use of space which use of CLARE sealed relays makes possible.

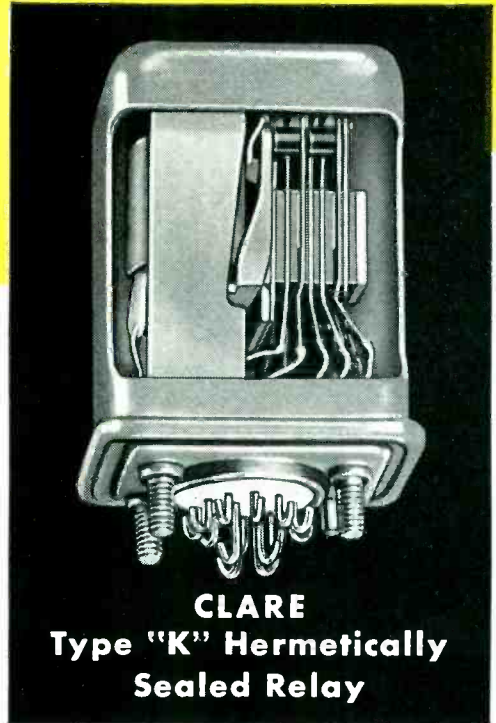

**CLARE
Type "K" Hermetically
Sealed Relay**

● Airborne Instruments Laboratory of Mineola, N. Y. uses CLARE Type "J" and Type "K" sealed relays as components of ruggedly designed but delicately operated control equipment for aircraft, ship and submarine.

These small, compact, space-saving relays are used in circuit applications that cover the broad field of low and high current, a-c and d-c switching and video switching. CLARE Type "J" and Type "K" Relays were selected for their outstanding speed of operation, dependable performance, resistance to vibration and very small size. Hermetically sealed in dry, inert gas, they are immune to changes in atmospheric pressure, humidity, dust or dirt . . . will operate as required over a long period.

CLARE relays have long been first choice of manufacturers whose products must not fail. Selection of highest quality materials, precise manufacture and ability to "custom-build" just the relay for a specific requirement have made CLARE relays first choice with engineers who insist on . . . and get . . . the best.

Sales engineers are located in principal cities to cooperate with you in the development of a CLARE "custom-built" relay that will meet your most difficult relay need. Look in your classified telephone directory or write: C. P. Clare & Co., 4719 West Sunnyside Ave., Chicago 30, Illinois. In Canada: Canadian Line Materials Ltd., Toronto 13, Ontario. Cable Address: CLARELAY.

CLARE RELAYS... ..

First in the Industrial Field

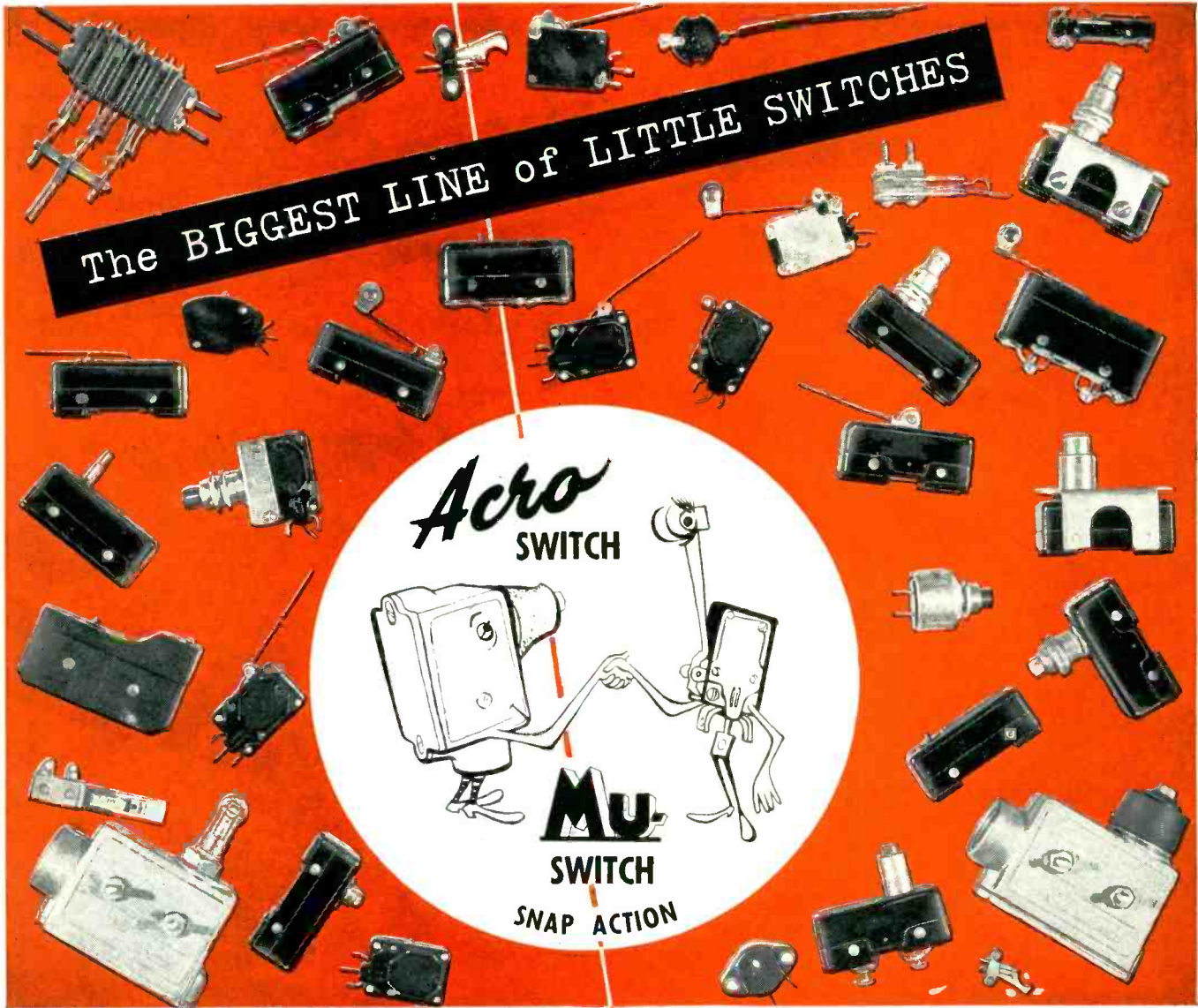

Now United

under the strong ownership-management of Acro Manufacturing Company, Mu and Acro snap-action switches comprise the finest and most complete line obtainable. The combined plants, with enlarged engineering and research facilities, are equipped to precisely manufacture (or develop, if required) the style switch which best suits your needs. To old or new Acro and Mu customers our expanded facilities will bring even better products and service. Design engineers are invited to submit their switch problems to us for speedy, economical solution. Write either location.

THE BIG NAME
IN
ELECTRICAL SWITCHES

ACRO MANUFACTURING COMPANY

MU SWITCH DIVISION
CANTON, MASS.

ACRO SWITCH DIVISION
COLUMBUS 16, OHIO

COIN SWITCHES, OPEN BLADES, PHENOLIC ENCLOSED, METAL CLAD, MINIATURES, HIGH VOLTAGE, D. C., PUSH BUTTON, PANEL MOUNTS

the

PRESTO PT-900

America's finest
portable tape recorder



Look at these features:

- Three heads for recording, playback, erasing.
- Separate recording and monitoring amplifiers.
- Three microphone input.
- Speeds: 15" and 7½"/sec.
- Frequency response: 50-15,000 cps.
- Power supply and amplifier in separate, leatherette covered cases.

The PRESTO PT-900 has been chosen by discriminating engineers, educators and broadcasters throughout the country as the best constructed, best performing, most durable, portable tape recorder available today. Combining the features of machines costing hundreds of dollars more, the PT-900 answers the need for a recorder of ultra-high fidelity in a completely portable, compactly designed unit. Built by the world's largest manufacturer of recording equipment and discs, the PRESTO PT-900 is precision engineered for years of satisfying service.

 **PRESTO** RECORDING CORPORATION
Paramus, New Jersey

In Canada: Walter P. Downs, Ltd., Dominion Square Bldg., Montreal, Canada
Overseas: M. Simons & Son Co., Inc., 25 Warren Street, New York, N. Y.

BUSINESS BRIEFS

By W. W. MacDONALD

the New PYRAMID "Humidi-Seal"

(TUBULAR PAPER CAPACITOR)



Ruggedly built to withstand undue vibration and rough handling

Outer tube plastic impregnated to prevent moisture-absorption

Light outer coat of high-temp wax provides double protection

Each end plastic sealed against moisture

Leads anchored securely in solid plastic end



Type 85TOC "Humidi-Seal" capacitors are specially designed for 85° C. operation, even in the most humid atmospheres, and will meet the severe present-day demands of endurance in television receivers, auto radios, etc.

WRITE FOR COMPLETE LITERATURE

Representatives and Distributors
throughout the U.S.A. and Canada



PYRAMID

PYRAMID ELECTRIC COMPANY

155 Oxford Street
Paterson, N. J., U.S.A.

TELEGRAMS: WUX Paterson, N. J.
CABLE ADDRESS: Pyramidusa

Better Men than this *Business Briefs* editor, in government and industry, are reshaping our economy to meet the requirements of peace, part-time police action or full-scale war. We are glad they are doing such planning, for the transition from the first condition to the second has already occurred and the third step seems probable. The only real uncertainty appears to be one of terminology and timing.

We think that no matter which way the bear jumps the devotion of American men and materials to purely military projects will eventually be at least equal to that which applied at the close of World War II. We think the electronics industry will ultimately face a greater manpower shortage, receive more military equipment orders, and have to suspend more civilian business than most people believe at this time. We think this will be more apparent after the November elections.

Having said all this, we can now report current news out of Washington, without further editorial comment.

Mobilization Plans already being implemented as this item goes to press lead Washington officials to believe that military orders for electronic items through the remainder of 1950 and fiscal year 1951 will total between \$2 billion and \$2.4 billion, with equipment actually shipped totalling about \$1.5 billion.

Electronic industry spokesmen say that if this is so military business will require about 25 percent of their plant capacity and manpower to handle. This might permit an industry goal of 6 million television sets and 10 million radio receivers to be reached in 1950, despite an anticipated sharp drop in December. A reduction in civilian business of from 20 to 25 percent would be sufficient in 1951. Military people think this is over-optimistic.

Some raw materials are already in short supply due to military

needs. Some component parts are in short supply due to heavy television receiver production and protective stockpiling. Allocations in some categories seem likely.

Three Major Groups have been set up by the electronics industry to work closely with the military. They are: (1) the National Electronics Mobilization Committee, which is a joint undertaking of RTMA and NSIA; (2) the Electronics Industry Advisory Committee, appointed in 1948 by the Munitions Board and NSRB; and (3) the Army Signal Corps Advisory Council.

Navy has set up a new Electronics Office, part of the Office of Navy Materiel located in the Executive Office of the Secretary of Navy. It will serve as a central point of contact for contractors formerly dealing individually with BuShips, BuAer, BuOrd, BuSupplies and Accounts.

Training Servicemen capable of handling electronic equipment to the satisfaction of the Navy Department in time of war costs from 10 to 100 times the value of the equipment these men maintain, according to L. V. Berkner of Carnegie Institute. It takes from two to four years, plus an additional four to ten weeks on each new highly specialized piece of equipment.

Editorial Assistant Jack Carroll went on *ELECTRONICS'* masthead last month. This month he is back in his Ensign's uniform and Somewhere in the Pacific.

Fascinating Fact of the month is the granting of permission to remain silent for one day to radio stations KFGQ and KFGQ-FM by the FCC. It seems that the stations are run by a biblical college and the staff needed a day off to attend graduation exercises in Iowa City.

Puerto Rico, because of a very lenient corporation and personal

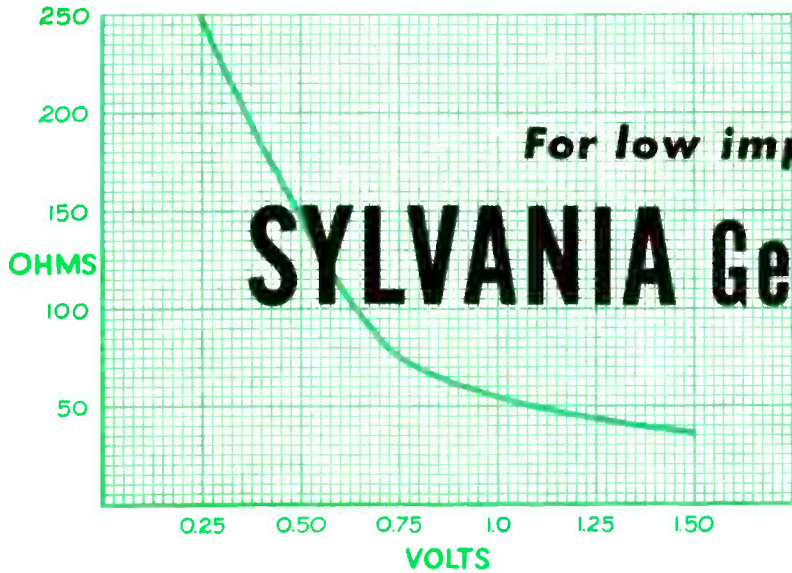

For low impedance applications...

SYLVANIA Germanium Diodes

Typical 1N56 Resistance Characteristic



1N56 DIODE with a potential of +1 volt will pass a current of 15 ma. or more. With a potential of -30 volts, less than 300 μ a. will flow.

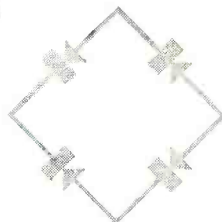

For Carrier Communications

1N71 VARISTOR—The 1N71 consists of 4 matched low impedance diodes each of which, with +1 volt impressed, will pass a current within one ma. of the average current of the four.

All Germanium Diodes are notable for their low forward impedance. But the 1N56 is specially engineered to make the most of this quality.

Use this diode for high efficiency circuits with low input and output impedances. Use it for relay activation, heavy current and surge applications with low impedance coils, transformers and condensers.

Try the 1N71 varistor in carrier telegraphy and telephony work. The low shunt capacitance insures high efficiency throughout the high frequency range. You will find this varistor equally efficient in low impedance modulator circuits of the carrier suppression or carrier transmission type.

Both the 1N56 Germanium Diode and 1N71 Varistor are available from Your Sylvania Distributor. Also ask him for a copy of the new book "40 Uses for Germanium Diodes." Priced at only \$1.00, it is the most complete collection of germanium diode applications yet published.

Call him today . . . or mail the coupon below.

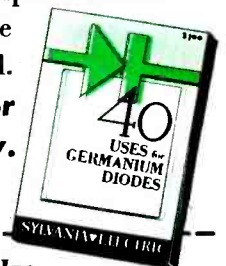

ELECTRONIC DEVICES; RADIO TUBES; TELEVISION PICTURE TUBES; ELECTRONIC TEST EQUIPMENT; FLUORESCENT LAMPS, FIXTURES, SIGN TUBING, WIRING DEVICES; LIGHT BULBS; PHOTOLAMPS; TELEVISION SETS

SYLVANIA ELECTRIC

Sylvania Electric Products Inc.
Dept. E-1010, Emporium, Pa.

Name _____

Street _____

City _____ Zone _____ State _____

SHOCK AND VIBRATION NEWS

BUSINESS BRIEFS

(continued)

There's a BARRYMOUNT for each of your needs!



AIRCRAFT MOUNTING BASES

Standard bases with dimensions to government specifications. Special bases to customers' exact requirements.



AIRCRAFT VIBRATION ISOLATORS

Unit isolators designed to meet Army, Navy, and CAA requirements. Stock mountings — 1/4 pound to 45 pound load range. Others on order.

SHOCK MOUNTINGS

For mobile, railroad, and shipboard electronic and electrical equipment. Also for isolation above 2000 c.p.m., and for general sound isolation.



INSTRUMENT MOUNTINGS

For electronic components, tiny fractional H.P. motors, record changers, dictating machines, and other lightweight apparatus.

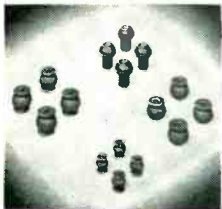

INDUSTRIAL MOUNTINGS

For fans, motor generator sets, transformers, presses, other heavy industrial equipment.

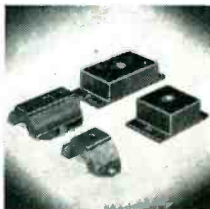

Free Catalogs give dimensions and load ratings of stock BARRYMOUNTS. Catalog 502 covers aircraft applications. Catalog 504 covers industrial and general-purpose mountings. **WRITE TODAY** to

THE **BARRY** CORP.

Main Office 177 Sidney St.

Cambridge 39 Massachusetts

New York Rochester Philadelphia Washington Cleveland Dayton
Chicago Minneapolis St. Louis Los Angeles Toronto

tax policy that is unique in the U. S., is being eyed as a plant location by a number of manufacturers. Already several people in our business have set up shop in the unincorporated territory and one or two others appear to be on the verge.

First Six Months of 1950 saw production of the following receiver totals by RTMA members:

	TV	Home Radios (inc. portables)	Car Sets
Jan	335,588	470,715	189,480
Feb	367,065	529,254	221,139
Mar	525,277	724,691	255,673
Apr	420,026	618,352	234,351
May	376,227	693,592	206,464
Jun	388,962	731,108	270,318

The 2,413,145 tv sets produced in the first half of 1950 compared with 913,071 made in the corresponding period of 1949. The 5,228,170 radio sets made compared with 3,481,858 made in the preceding comparable period.

F-M and F-M—A-M radios included in the figures above totalled 539,852 in the first six months of 1950, an increase of 115,000 over the first six months of 1949. In addition, 225,673 of the television sets made from January through June this year had f-m reception facilities.

Receiving Tube Sales by manufacturers totalled 170,375,921 in the first half of 1950 as against 81,663,213 in the first half of 1949.

Electrons, Inc. says Detroit is still number one market for industrial thyratrons of its manufacture, but that Milwaukee and Cleveland are running a close second and third. We wonder how these and other cities stack up as industrial electronic equipment markets for others.

Heard In A Lab, and applicable in many other walks of life: "He has an unerring instinct for the unimportant."

Mexican XHTV is now transmitting television programs on a commercial basis two hours nightly, transmits music and a test pattern two additional hours each day. At least three major U.S. television receiver brands are be-

ing sold in quantity in Mexico City.

In July we mentioned a 700-outlet master television antenna system installed in New York and invited correspondence from anyone who knew of a bigger job. Curtis Pierce of RCA Victor Distributing now tells us that Roberts-Stage Electric is completing a 740-unit installation suitable for both television and f-m on Chicago's Lake Shore Drive.

New Product Ideas are always interesting to manufacturers. If you have one tell us about it. Maybe we can help.

Advertising Copywriters are indeed ingenious in the matter of artwork. Looking through the ads in one of our recent issues we note the presence of such widely assorted eye catchers as flying saucers, Indians, tight-wire artists, ghosts, magicians, elephants and butterflies.

September Issue Ads:

Just two pieces of copy make a direct bid for military business. However, several makers of temperature, pressure and humidity test chambers, and vibration testers, are back in print for the first time since World War II.

Three tube makers feature special long-life industrial types.

We are intrigued by the terms "mush-wound" coils and "ground worms (hard or soft)".

Quality of editorial material is the thing we strive for on **ELECTRONICS**, but you get quantity too. The average issue weighs 23 ounces.

Self-Hypnosis may be accomplished with a photoelectric relay controlling a 10-watt lamp, according to the Photobell Company. "The lamp is placed near the phototube, causing rapid oscillations controllable by varying the adjusting knob. Adjust the frequency by trial to match your eye requirements, look closely, and . . ."

And what wakes you up, a power failure?

SIGMA

Sensitive Relays



SERIES 4

SPDT GENERAL PURPOSE SENSITIVE D. C. RELAY. Inexpensive Balanced armature for *vibration resistance* on aircraft at 50 milliwatt adjustment. Sensitive enough for V-T operated relay circuits; can be set to operate down to 10 milliwatts. Precision adjustments for pull-on and drop-out. 2 amp. nominal contact rating. Coil resistance up to 14,000 ohms.

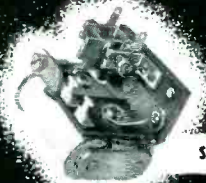

SERIES 5

SPDT VERY SENSITIVE D. C. RELAY. Balanced armature and magnetic efficiency resist aircraft *vibration* on inputs as low as 5 milliwatts. Withstands 500g shock without damage. Precision adjustments. 2 amp. nominal contact rating. Coil resistance up to 16,000 ohms. Special adaptations: Built-in rectifier, two-coil differential operation, constant voltage temperature compensation.



SERIES 41

SPDT SENSITIVE RELAY AC-DC-KEYING. Unusual characteristics at low cost. Same D. C. sensitivity as Series 4 but less flexibility of adjustment. Available with long life and bounce-free contacts, it is suited to high speed counting and keying. Mechanical life exceeds 10⁹ operations. Good for plate circuits needing moderate precision and vibration immunity. Contact ratings up to 5 amps. Coil resistance to 14,000 ohms. A. C. sensitivity exceeds 0.1 V.A. at 60 cps. Serviceable on frequencies from 16-400 cps. Protects delicate thermostat or instrument contacts.



SERIES 6

MULTICIRCUIT POLARIZED SENSITIVE RELAY. Single or double (differential) windings. Resistance up to 25000 ohms total. Contacts up to 4PDT, 5 amp. nominal rating. Balanced armature for strong vibration resistance. FORM X—Three Position or Null Seeking. For automatic positioning or 2-Way process control. Sensitivity (depending on contact complexity) from 10 to 100 milliwatts. FORM Y—Biased (Spring Return). Use as an ordinary sensitive relay if a complex contact combination is needed. Combines function of pilot relay and contactor. Sensitivity same as Form X. Responds only to one polarity. FORM Z—Latching (*permanent magnetic*). Replaces mechanical latch electrical reset relays, where longer life and greater vibration resistance is required. Sensitivity from 100 to 250 milliwatts.



SERIES 7

SPDT SENSITIVE HIGH SPEED POLARIZED RELAY. Single or multiple windings up to 14,000 ohms (single). Balanced armature. Nominal contact rating 2 amps. For repeating *telegraphic signals* at speeds up to 250 W.P.M. Small in size and weight. Hermetically sealed. Mechanical life exceeds 10⁹ operations. FORMS X, Y and Z (see Type 6 above) available in Series 7. Sensitivities from less than 1 to 10 milliwatts depending on form and requirements. Form X is useful as the detecting element in positioning bridge circuits.



VARIETY OF ENCLOSURES

In addition to the open styles shown, SIGMA Relays are available with dust-proof or hermetically-sealed enclosures. Most types are available for either plug-in or permanent solder-lug connections.



WRITE FOR FULLY DESCRIPTIVE CATALOG

SIGMA Instruments, Inc.

SENSITIVE RELAYS

62 Ceylon Street, Boston, Mass.

**Value
Beyond
Expectation!**

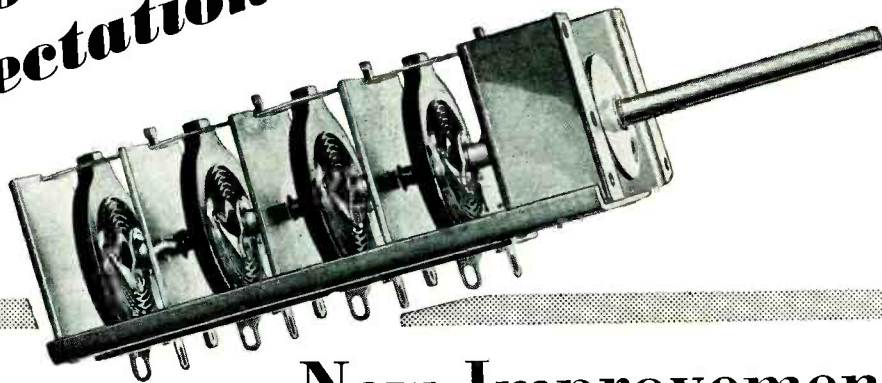

New Improvements in Mallory Inductuner* for Television Receivers

Outstanding Advantages of the new Mallory Spiral Inductuner:

1. A single control for easy selection and fine tuning of any television or FM channel.
2. Easily adapted to UHF converter use.
3. Excellent stability eliminates frequency drift.
4. Supplied in three- or four-section designs.
5. Far more quiet operation; permits high signal-to-noise ratio in front end designs.
6. Free from microphonics.
7. Greater selectivity on high frequency channels.
8. Eliminates "bunching" of high band channels.
9. Simplifies front end design and production.
10. Reduces assembly costs.

*Reg. trade mark of P. R. Mallory & Co., Inc. for inductance tuning devices covered by Mallory-Ware patents.

Now there are important new reasons why the Mallory Inductuner should be first choice for your TV receiver. Each one offers more convenience to the set owner, new economy for you, without any sacrifice in the performance advantages of the continuous tuning principle . . .

Improved Inductuner eliminates "dead zone" from continuous tuning; covers entire TV range from 54 to 216 megacycles, including FM, in only 4 revolutions!

Improved Inductuner covers entire TV spectrum in only 3 revolutions, if FM is not required!

Improved Inductuner can be channel-indexed for touch-tuning without dial watching . . . still provides fine-tuning adjustment!

Finally, the Improved Inductuner is available at low cost and will make important savings for you in assembly and alignment operations.

That's Value Beyond Expectation!

Write for technical details. Also inquire about the surprisingly low cost and superior performance of the suggested front end designs which Mallory engineers have developed around the Inductuner.

Television Tuners, Special Switches, Controls and Resistors

SERVING INDUSTRY WITH

Capacitors	Contacts
Controls	Resistors
Rectifiers	Vibrators
Special	Power
Switches	Supplies
Resistance Welding Materials	

P. R. MALLORY & CO., Inc.
MALLORY

P. R. MALLORY & CO., Inc., INDIANAPOLIS 6, INDIANA



CROSS TALK

► **BLOOPERS** . . . Major Armstrong has reminded the industry that local oscillator radiation, now so troublesome in the f-m and tv bands, is an old problem, licked long ago in regenerative and superhet sets for the broadcast band. In a strong letter read before the RTMA f-m receiver committee he cites measurements on a particularly bad f-m receiver, with no r-f stage, that developed a full volt of local oscillator voltage across the antenna terminals, and compares it with a better receiver developing 20 millivolts.

We agree with the Major that keeping the radiation voltage down to 20 millivolts is good engineering, but unfortunately it's not good enough. If it were, the tv band would not be in the trouble it's in today. Measurements on tv receivers of twelve manufacturers, recently conducted under RTMA auspices, showed that the voltage across the antenna on channels 2 through 6, adjacent to the f-m band, was under 20 millivolts in 12 models of the 14 tested. The majority were below 10 millivolts on channels 2 through 6.

The mark to shoot at is one millivolt across 300 ohms for these channels. Such a radiated voltage represents only 3 billionths of a watt radiated, and produces a field of 15 microvolts per meter at 100 feet. Even on the low-band channels, achieving this low level is difficult. On the higher channels, thus far, it has

proved almost impossible to meet this mark, because radiation direct from the chassis comes into play when the wavelength is only a few times the maximum dimension of the chassis.

The development that licked the problem on the broadcast band, so far as we are able to determine, is the built-in loop antenna. The majority of a-m sets now made use loops, and no r-f stage. But the loop is such a poor radiator that the radiation is held to an acceptable level. We wish that some equally simple solution were available to f-m and tv designers.

► **TV NATIONS** . . . A checkup reveals that as of September 1, public television service of one sort or another is being rendered in eight countries. In the Americas, stations are operating on 525 lines in the U. S. A., Mexico City and Sao Paulo (Brazil). A second Brazilian station, in Rio de Janeiro, is scheduled to start on 625 lines, the difference in scanning being predicted (wrongly!) on the power supply frequency. Equipment for 525-line service has been shipped to Cuba and should be on the air this fall. In Europe stations are on the air in London and Birmingham, Paris, Eindhoven (Holland) Milan, and in Russia. Experimental transmissions, without public participation, are reported to be under way in Denmark and Sweden.

Many new stations can be ex-

pected in Europe, now that the European standards have been agreed on. Word from Geneva has it that the European nations (except France and England) have definitely settled on 625-line, 25-frame scanning, as anticipated in our last report (August issue, p 70). Negative modulation and f-m sound, following U. S. A. practice and opposed to the British recommendations, have been adopted. The channel width is 7 mc. Except for the adoption of 25-frame scanning, which will put the European system at a disadvantage from the flicker standpoint, the choices made at Geneva are a sound basis for television service, and reflect a careful study of alternatives.

► **RED FEATHER** . . . The symbol on our cover this month is a reminder that October is Community Chest month. Two of our leading industrialists, whose names are 100 percent correlated (Charles E. Wilson, president of General Electric and Charles E. Wilson, president of General Motors) are national campaign chairman and vice-chairman respectively. The Wilsons point out that the one-campaign method is a very sound way of raising money, from a business standpoint, because the production costs drop as the volume increases. The campaign is not only sound in method, it is free-enterprise humanitarianism at its best. Give enough!

NEW IDEAS In

By **NEWLAND F. SMITH**

*Engineer in Charge of Television
WOR-TV
New York, N. Y.*

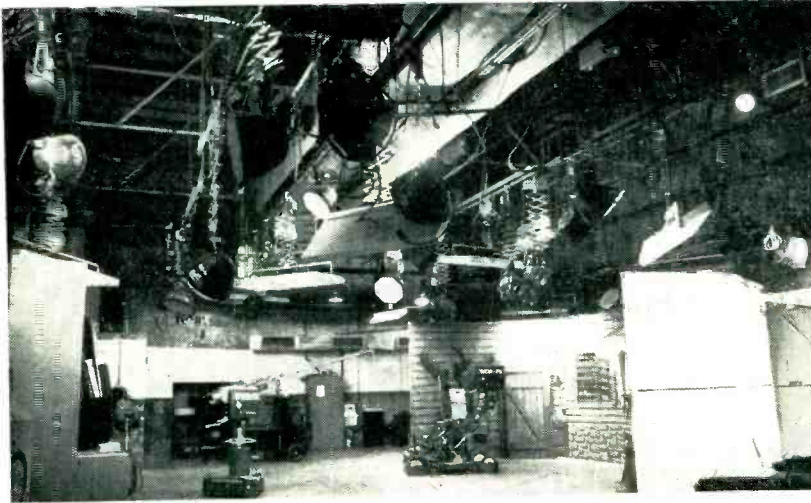

General view of studio A. Each studio has its own program control room from which program director, video switcher and audio operator watch action. Cameras are controlled from central control room which views both main studios from second floor

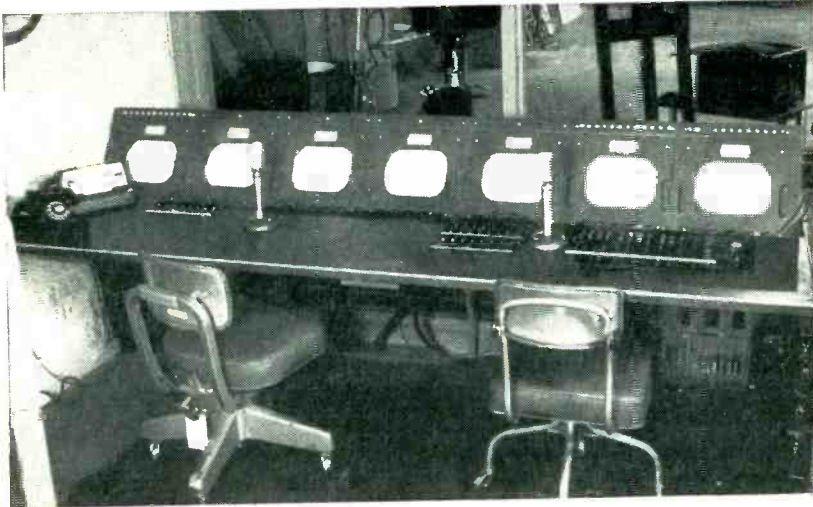

Program control room. Director's console is designed for unobstructed view of studio

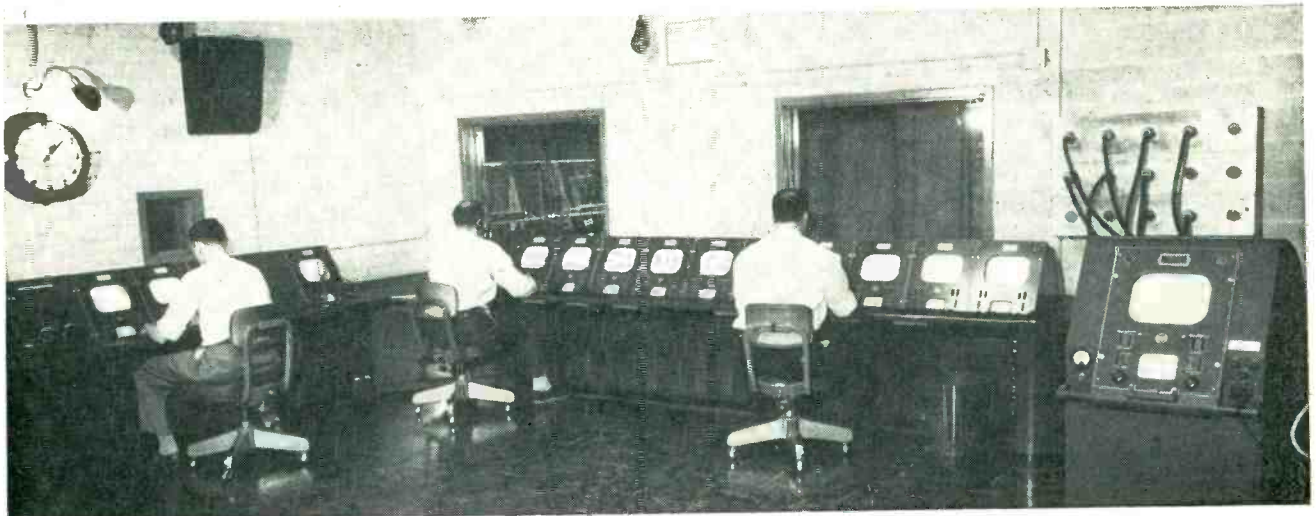

Camera control center. Here operators set outgoing video levels and maintain electrical focus on all cameras. Camera cable patch panel is visible at extreme right

DEMANDS ON TECHNICAL FACILITIES at television studios vary from program to program and from day to day as new techniques and ideas are developed. In order to keep up with constantly-changing requirements, the arrangement of equipment must be extremely flexible.

A new approach to the problem of television studio design has been made at WOR-TV. A maximum of attention has been directed toward getting the most out of available technical equipment. Facilities are provided for rapid and effortless interchange of equipment from scene to scene and from studio to studio. Careful planning has reduced the number of camera chains required, while at the same time production problems have been eased.

The setup includes two large studios, two announce studios, three program control rooms, film

Television Studio Design

Separation of program direction and technical control solves many problems and enables station to get more out of available facilities. Central camera control provides increased flexibility and efficiency with less confusion and complication

projection facilities and a camera control center. The space is divided as shown in Fig. 1.

All camera-control facilities for all studios are centrally located in the camera control center. Thus, camera-control operation is removed from the actual studio control rooms which are called the program control rooms.

Program director, video switcher, and audio operator are located in these program control rooms. The program director's console has seven 10-inch picture monitors. These monitors are directly in front of the director, enabling him to have a close view of each camera and signal available for his program make-up. The console has a lower top than is normally used in television consoles, providing a good view through the studio window onto the studio floor. Here the program director finds no distraction from the camera control operators

being between him and his monitors, as in the usual setup, making concentration on his production that much easier.

Video Switching

To the right of the program director, who normally sits in the center of the console desk, sits the video switcher. He has, in front of him on the desk top, a sixty-button control panel, which enables him to do the necessary camera switching as called for by the director.

The panel uses d-c voltages to energize video-switching relays which are centrally located for all studios in the camera control center. The control panel consists of five rows of buttons. It may be seen on the right-hand end of the desk in the program control room photograph. The lower row of controls provides for the switching of any one of the twelve inputs to the outgoing program line, and represents,

therefore, the program output of this studio. The next two rows select inputs for the effects mixer amplifier. The gain of each section of the mixer amplifier can be controlled independently or simultaneously by a fader lever located to the right of the buttons. The output of the effects mixer is brought back into the main switching bank in the number twelve position, thus providing for the switching of a super-position or a lap dissolve directly onto the program line by pressing the number twelve button in this row.

Two additional rows of buttons on the top of the panel enable either of the two preview monitors located in the console to be switched at will to any one of the twelve inputs to this switching system.

Program Patching

All required signals for a particular program are sent to the program-control-room switchboard through a coax patch panel located in the camera control center. With the normal arrangement, the first eight positions on each studio-control switching system are reserved for camera inputs, that is, signals with video and blanking only. The next three positions are reserved for composite video signals. This enables a remote signal to be switched in as part of a studio program in any of the studio control rooms where it is required.

The video switching relays used in the system are the standard RCA TS-20A switching relays. In these, the timing is dependent on only one relay for each outgoing channel, thus simplifying adjustment. In

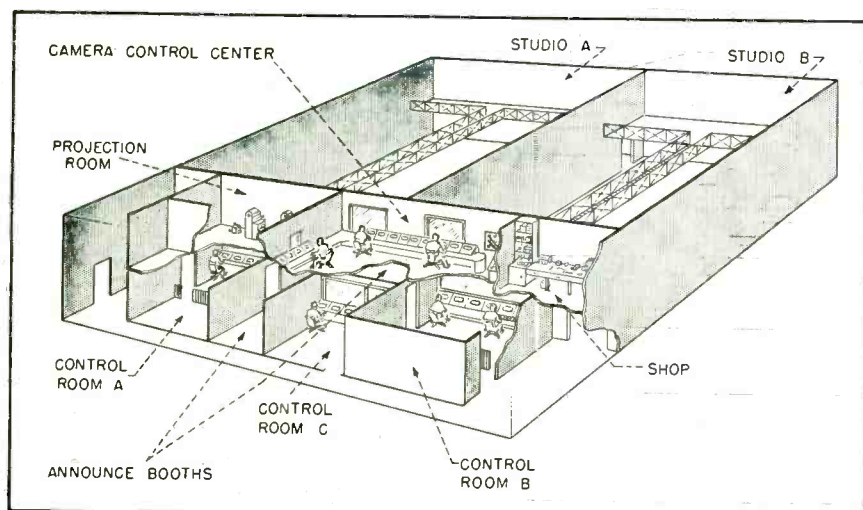

FIG. 1—WOR-TV's new 67th Street studio building is designed to afford most efficient use of technical facilities

switching a television signal, time delay is very important and has been reduced in these relays to approximately one millisecond. In the case of the program bank of relays, the transfer relay is set to produce an overlap in the switching. That is, the two cameras are momentarily on together at the time of switch-over. This gives a smoother appearance on the outgoing signal than a gap between the two cameras. It does, however, momentarily parallel the output of the camera control units during the one-millisecond switchover. This does not reflect back in any other outgoing signal.

In the case of the effects and preview switching relays the timing has to be set for a gap in switching. It is necessary to use gap switching here in order that switching of cameras on the preview or effects

busses will not disturb cameras that may be feeding the outgoing program line.

The camera switching system, which is identical for all studios, is shown in block form in Fig. 2. The switching relays incorporate in each outgoing bank a cathode follower which isolates the capacitance of the outgoing line from the incoming camera circuit. In this manner a uniform frequency characteristic through the video bank is obtained out to seven megacycles. It is necessary, however, to keep the cable to the isolation amplifier as short as possible.

Camera Control Center

All control units for both film and studio cameras are located in the one central control room as shown in Fig. 3. Central camera control

operators merely set levels on the outgoing video signals and maintain proper background and electrical focus on each of the cameras. A line monitor is incorporated in the camera control console for each of the studio control rooms. Thus, the camera control operator can readily check his levels after being switched onto the program line.

The camera cable patch panel on the wall of the camera control center enables any of the eight studio camera control units to be patched into any of fifteen outgoing cables. These cables are routed to the different studios and announce booths. Any combination of the eight studio cameras can be distributed to the studios as required for a given program. In addition to distributing the cameras to the various studios as required, it is, of course, necessary to patch the video output of the camera chain to the proper camera-switching control position, where the show is to be directed.

A tally-and-intercom patch panel enables the tally light signals that are furnished by the switching relays to energize the corresponding camera control monitors and cameras when they are switched on the air. The same patch cord also carries order wire and program audio to the headsets of the camera control operators and the cameramen. Thus, at each of the camera control positions the operator can plug in a headset which will give him communication with the video switcher in the appropriate program control room, and also with the cameras that he is controlling. In addition, the program audio is fed to the camera operator from his studio.

The film camera controls located to the left of the studio camera controls are operated in a similar manner, with the exception that the camera cable is connected directly from the film cameras in the projection room to their corresponding camera control units. The video outputs of the film camera controls may be patched at the video patch panel into any of the three studio control rooms for switching as required. Thus we have the provision in any one of three studio control rooms to switch in film inserts or

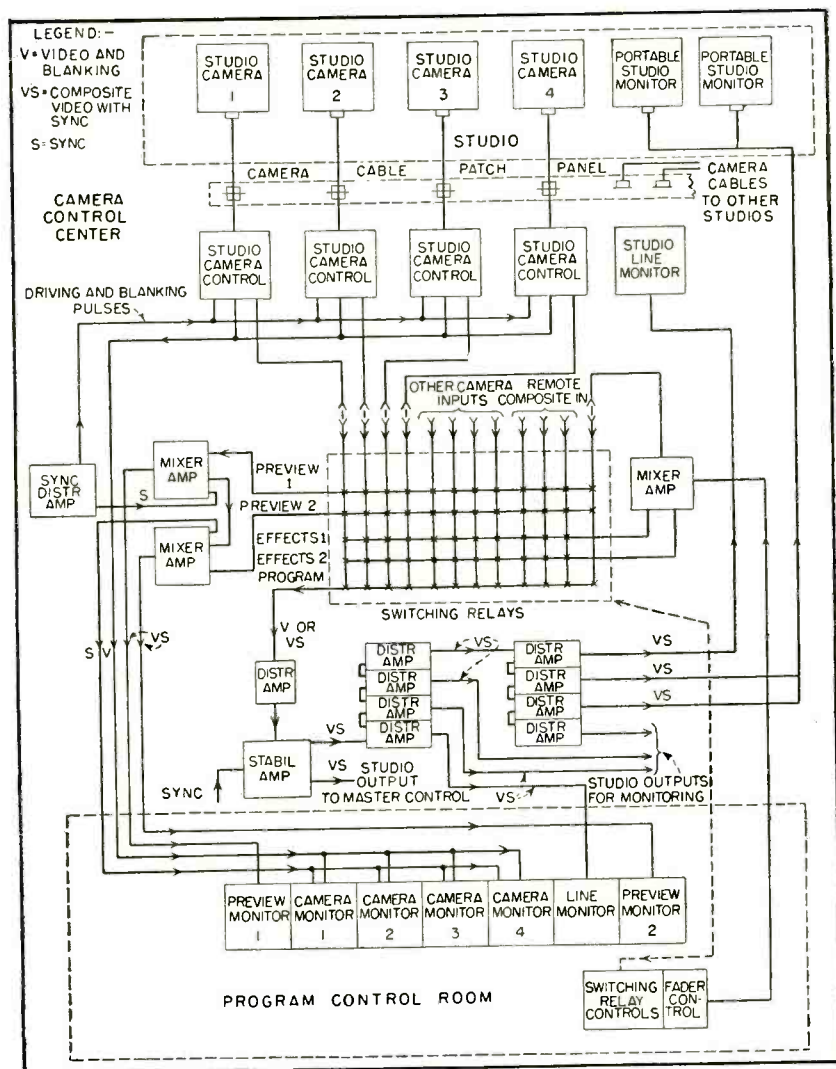

FIG. 2—Video switching is accomplished by remotely-controlled relays located in the camera control room

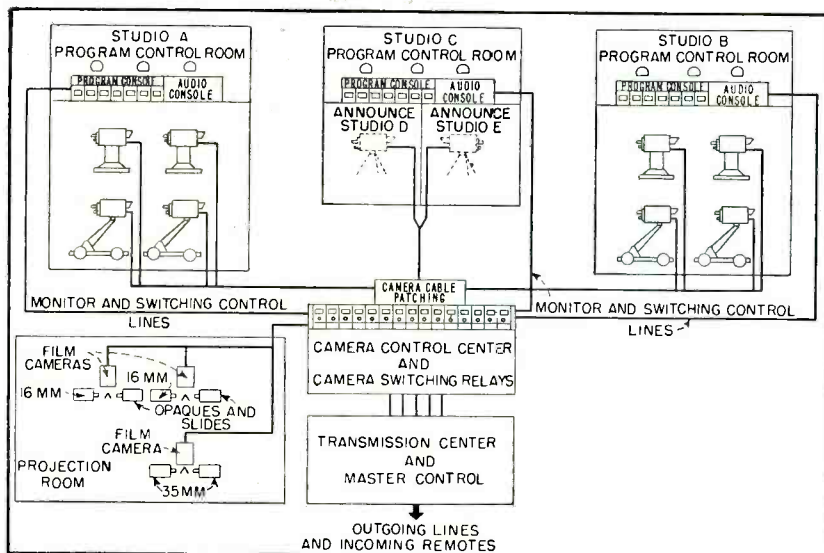

FIG. 3—Complete equipment diagram shows wide variety of combinations available through the use of separate program and camera control rooms

slides, as well as any of a number of studio cameras, depending upon the size of the production.

Advantages

By centralizing the camera control units some of the control operators who have been working with one studio can switch immediately to a program from a second studio, since it requires no physical movement from one room to another. It is possible to realize a saving in operating personnel. Also, the quick interchange of camera control sections, by use of the camera cable patch panel, makes it possible to replace defective units quickly in case of trouble during a rehearsal or actual program.

An additional advantage of the centralized control room is a simplification of the cable-delay problem which normally occurs when several studios are operated at different distances from a central master control room. In this case it is customary to delay the horizontal driving and blanking pulses of the nearer studio control rooms, so that the time delay is equal to that of the studio control room having the greatest cable distance to the master control room. By having all of the camera control units for all studios located at one point the same delay between synchronizing and blanking pulses holds, regardless of which studio control room is used.

By centralizing the camera-control equipment and the camera-switching equipment for all studios in one place, the actual program signal does not appear in nor is it routed through any of the studio control rooms. The monitors in the individual studio control rooms are fed by lines from the camera control center, which merely bridge the program circuits in the camera control center.

Power Supplies

In addition to the switching relays and associated amplifiers, the camera control center contains the necessary power supplies for all of the studio equipment, including monitors in the individual program control rooms. There are approximately 150 power supplies which occupy 20 cabinet-type racks. All of these power supplies are of either of two standard types. They are all of the plug-in type, which means that spare units can be quickly substituted in case of failure of any individual power supply. A power-cable extension cord with suitable connectors is always kept available for patching in the d-c outputs of the spare supplies when required.

Centralizing all power supplies simplifies the power distribution problem and eliminates much of the heat from the studio control rooms. Furthermore, a reduction can be made in the number of spare

units required to take care of several studios.

Projection Room

The projection room, located adjacent to the camera control center, contains three TK-20A iconoscope film cameras. Each of these is multiplexed by means of a mirror system to provide three sources of film or slides for each film camera. Two 16-mm projectors, two 35-mm projectors, opaque projectors, and slide projectors comprise the projection equipment.

Cabinet racks contain picture monitors for each of the film camera chains as well as space for audio and intercom amplifiers. An intercom system consisting of a microphone and talk-back speaker is suspended over each film camera assembly. The intercom system can be tied in individually with any of the studio control rooms that the film camera should be associated with on a given program. In this way one film camera chain can be used for a rehearsal with one studio control room, while another film camera chain is being used with a second control room to produce a show on the air. In the same way that tally lights indicate studio cameras are on the air, tally lights on the individual film cameras show when each is placed on the air by a studio control room. The tally signals are fed through the tally patch panel in the same way that the studio camera tallies are fed.

Master Control

The master control facilities are located in the same room as the

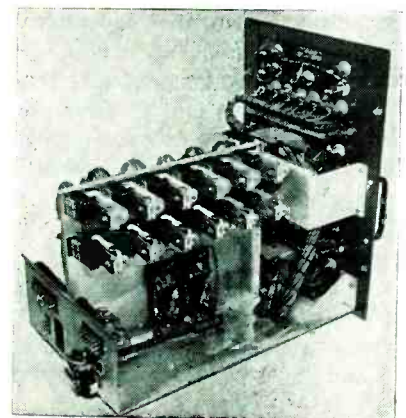

Video switching relays like these are energized by d-c from program control rooms

camera control center, and actually are one half of the large U-shaped console. The switching facilities consist of equipment to switch six incoming studios to four outgoing channels. Both audio and video are switched here, and individual picture and audio monitors are provided on each outgoing channel. All switching is done by relays. The switching relays set for gap timing are used for the video switching and a special audio-relay switching system has been built up to accompany this.

All switching can be preset and provision is made for either simultaneous audio-video switching or independent audio and video switching if required. Normally, only simultaneous audio-video switching is used, since only complete programs are switched at the master control point. However, if required to hold over the audio from one studio to another, and switch only the video, this can be accomplished, and the audio switched at a later moment. Provision is also made for tripping all four outgoing channels simultaneously when required, or for switching them in groups or individually.

At this point in the system only composite signals are handled, and no provision is made for lap dissolving or fading. Fading is always a program function, and should be handled when so required at the direction of a program man in one of the studio control rooms. Each outgoing channel is provided with a stabilizing amplifier in its output, so that the picture level and synchronizing level may be set independently on that particular channel. Corresponding audio-gain controls are also provided on each outgoing channel.

The transmission center is really a part of master control. Two additional console sections are provided with TM-5A picture monitors, which can be fed from any of the six inputs to master control. The inputs to these monitors are switched by control buttons directly in front of the monitor. Any of the inputs to master control can be previewed here before actual switching.

Adjacent to the monitors are located remote controls on six stabilizing amplifiers. The controls en-

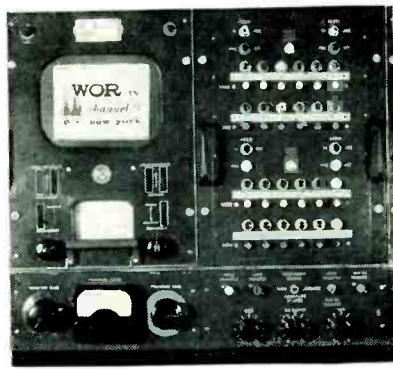

Master control switching console

able the operator to match the levels on all of the studio outputs as well as any remote outputs which may be patched in for checking.

Phase Comparison

A means is provided for comparing the phase of an incoming remote signal with that of the local synchronizing system. This is done by switching the vertical driving pulses of the local sync generator onto the grid of the cathode-ray oscilloscope in one of the preview monitors. This blanks out the period of the local vertical synchronizing signal, and when a remote signal is switched up on this monitor a portion of its synchronizing will be blanked out. When the blank period is phased so that the vertical disappears, then the two synchronizing generators are properly phased as regards vertical synchronizing. Normally, the phase of the remote sync generator is changed to bring it in with that of the local studio sync generator. Thus, the studio sync generator is kept as a standard.

Remote controls on the phasing of the local sync generators are brought over to this console section also, so that when required the phase of these generators can be changed conveniently. In addition, a remote-control switch is provided so that a stand-by sync generator can be switched in in place of the regular generator as an emergency. It is important that the two local generators be previously phased.

Provision has been made for utilizing the new RCA Genlock unit. This will enable remote signals coming in to control the phase of the studio sync generator line-by-line. A remote signal coming in can be treated as a local camera,

and when patched into any of the studio control rooms can be faded and lap dissolved with local cameras. To treat the signal this way it is necessary to wipe off the synchronizing component on the incoming remote by means of one of the TA-5C stabilizing amplifiers. The synchronizing thus removed is fed into the Genlock unit to provide afc control on the local sync generator. Synchronizing from the local generator is then finally mixed with the output of the studio control room to provide a composite signal for both local cameras and remotes.

Remote signals come into the building through Telco video lines. Approximately twenty-four circuits are available from different points within the city where remotes are handled. One circuit comes from the microwave receiving location on the Empire State Building, where many remotes are received, and is then routed to the master control.

Results

This studio system has been in use since the first of the year, and has worked out very well. On some of the larger productions both studios have been used for one show. In this case as many as seven camera signals have been switched in one studio control room to make up a given production. On other occasions rehearsals have been conducted in one studio concurrent with an on the air show from another studio control room. The flexibility of the system has been very apparent in the rearranging of camera facilities to meet the individual requirements of different types of productions.

With the present setup, only three program control rooms are used. Undoubtedly, the future of television will require many more studios. In such a system the same basic principles that have been used in the WOR-TV studios could be extended to provide the same advantages. It may be that a practical limit, as to the number of camera control units that might be located in one center, would be reached. In that case, two or more camera control centers might be provided for, say, six or eight studios, to form a practical arrangement.

SUN FOLLOWER for V-2 Rockets

Automatic tracking device keeps spectrograph in nose of V-2 rocket pointed at sun for making intensity measurements at wavelengths as low as 500 angstroms. Servo-drive system resembles SCR 584 auto-track principle, except that error signal is derived from photocell mounted in rocket

KEEPING a spectrograph in a spinning V-2 rocket pointed at the sun is accomplished by a photocell-controlled servo-drive mechanism called the sun follower. By lengthening the available exposure time, measurement of radiation intensities down to 500 angstroms has been made possible. Hitherto observation of solar spectra from photographs taken by ultraviolet spectrographs in the nose or tail of V-2 rockets passing through the ozone layer has been limited to wavelengths above 2,000 Å.

To overcome the effects of the rocket's angular motion, a two-axis tracker was developed for stabilizing the spectrograph and keeping it pointed at the sun regardless of the spin and precession of the rocket. Automatic detachment and descent by parachute are provided to facilitate recovery of the sun follower and spectrograph.

Requirements

The behavior of the rocket in flight is depicted in Fig. 1. During the burning period, axial-spin and precessional velocities are imparted to the rocket and remain approximately unchanged from a few seconds after burn-out until the denser atmosphere is encountered on descent. A typical rocket assumes axial-spin velocities up to 50 rpm in either direction, and precessional velocities up to 10 rpm in either direction at angles up to 20 degrees to a precessional axis which may be inclined up to 20 degrees from the vertical.

By **HARRY L. CLARK**

Head, Applied Optics Branch
Naval Research Laboratory
Washington, D. C.

Built into the nose of the rocket, as shown in Fig. 2, and timed to operate above the denser portion of the earth's atmosphere after doors in the rocket's nose have opened, the sun follower stabilizes by means of error signals derived from the sun. This is accomplished with a photocell error-signal generator and two independent servo-drive units. The azimuth axis is collinear with the longitudinal axis of the rocket. The elevation axis is perpendicular to the axis of the rocket and rotates about it. By

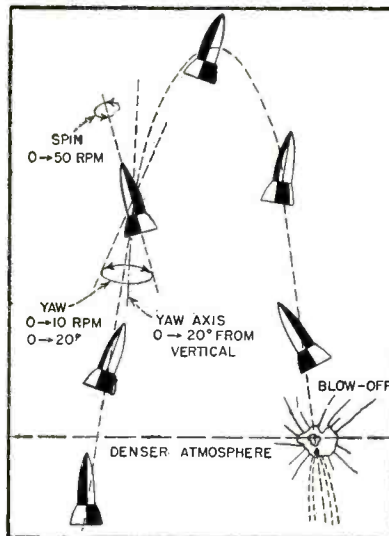

FIG. 1—Typical V-2 flight pattern shows precession and spin that limit spectrograph exposure time

tracking with an error of less than one-half degree in both azimuth and elevation, the sun follower permits the use of a spectrograph capable of recording wavelengths as short as 500 Å.

Stabilization

The principle of the stabilization system is similar to that of the tracking unit employed in the SCR-584 radar, except that the photocell error-signal generator and low-frequency amplifier replace the radar's r-f transceiver. A block diagram is shown in Fig. 3. A real image of the sun is focused by a lens onto a rotating shutter situated in the focal plane with its center on the optical axis. The shutter (Fig. 4) is constructed of transparent material upon which is placed a number of equally-spaced, radial, opaque spokes. Superimposed on the spoke design is a pattern of linear shading. The spokes chop the sun's radiation at 400 cps producing a 400-cps carrier. The linear shading modulates the carrier at 40 cps. The degree and phase of modulation of the 400-cps carrier are determined by the position of the sun's image on the shutter. A photovoltaic cell placed immediately behind the shutter intercepts the 40-cps-modulated, 400-cps light signal and converts it into a proportional electrical signal which is amplified, maintained at constant level with avc, and demodulated.

The resulting 40-cps signal is then fed into a two-channel phase-comparator circuit. In the azimuth

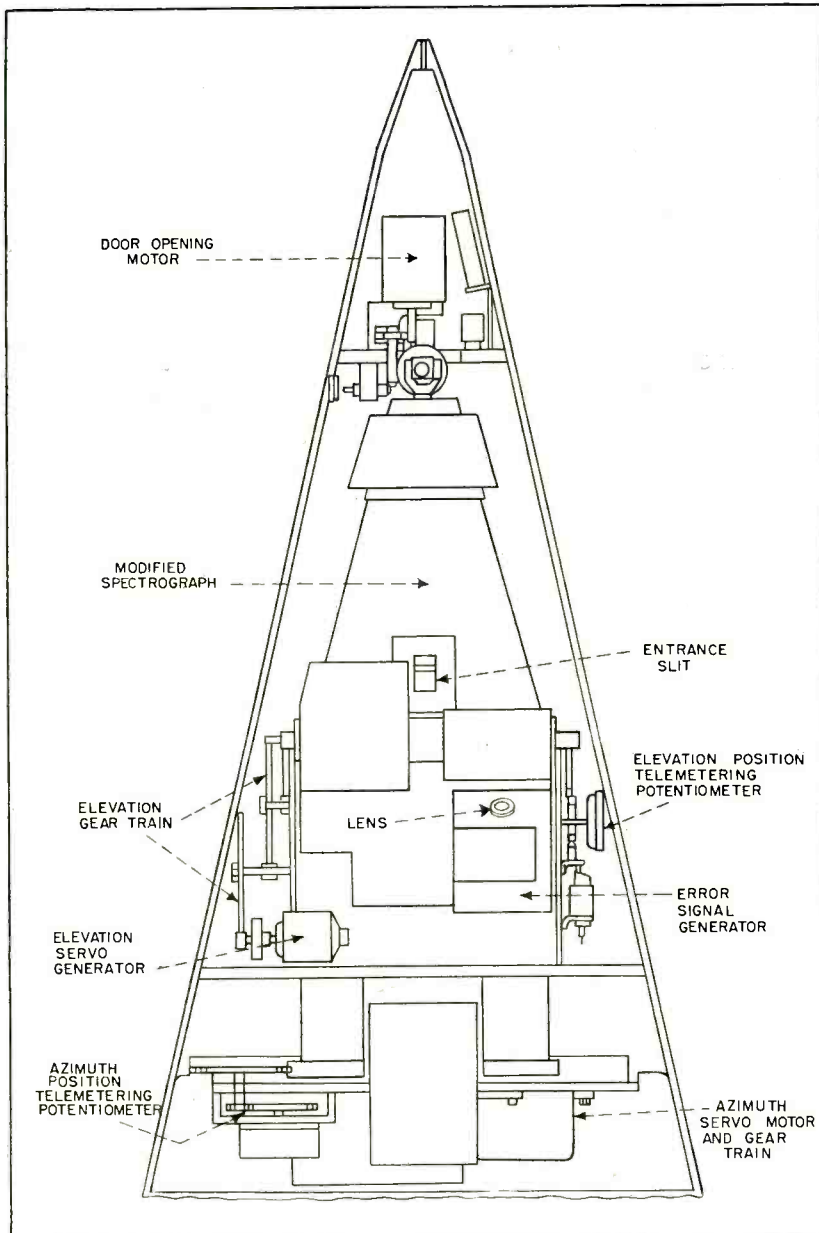

FIG. 2—Rotating nose of rocket compensates for spin while spectrograph is elevated to overcome precession

channel the phase of the signal is compared with the phase of a fixed 40-cps voltage from a reference generator which rotates in synchronism with the shutter. In the elevation channel, the phase of the signal is compared with that of a second fixed 40-cps voltage which is in quadrature with the fixed voltage of the first channel. The results of the phase comparisons in both channels are two independent d-c voltages whose magnitudes are functions of the differences in phase between the respective signals and fixed voltages which produced them and are proportional to the magnitudes of the respective demodulated signals.

This dual relationship makes the respective d-c output voltages directly proportional to the horizontal and vertical displacement of sun from the center of the shutter and hence the optical axis.

Displacement Voltages

For example, if the sun's image is positioned on the optical shutter at a distance R from the optical axis and the resulting differences in phase angle between the 40-cps modulation on the 400-cps carrier and the azimuth and elevation reference voltages are α and β respectively, then the following proportionalities hold for the d-c voltage

swings, ΔV_{az} and ΔV_{el} in the azimuth and elevation channels

$$\begin{aligned}\Delta V_{az} &\propto \cos \alpha \\ \Delta V_{az} &\propto R\end{aligned}$$

and

$$\begin{aligned}\Delta V_{el} &\propto \cos \beta \\ \Delta V_{el} &\propto R\end{aligned}$$

combining

$$\begin{aligned}\Delta V_{az} &\propto R \cos \alpha \\ \Delta V_{el} &\propto R \cos \beta\end{aligned}$$

therefore

$$\begin{aligned}R \cos \alpha &= X \\ R \cos \beta &= Y\end{aligned}$$

In other words, the d-c voltage swing in the azimuth channel is directly proportional to the right-left displacement, X , of the sun's image and the d-c voltage swing in the elevation channel is directly proportional to the up-down displacement, Y , of the image. This is true for image displacements up to 25 degrees off the optical axis and is determined by the extent of the linear portion of the shading on the optical shutter. Beyond 25 degrees to the edge of the shutter the shading is a maximum and constant.

After amplification the two d-c voltages are employed to control, individually, the outputs of the azimuth and elevation amplidyne. These in turn control the azimuth and elevation servo motors. Portions of the amplidyne outputs are fed back into the last stages of the amplifiers for antihunt control.

The only stable condition for the system exists when the image of the sun is on the optical axis of the error-signal generator. Other positions of the sun's image result in the generation of restoring torques in the azimuth and elevation channels which are directly proportional to the magnitudes of the respective horizontal and vertical displacements of the image. Since the optical axis of the ultraviolet spectrograph is mechanically aligned with the optical axis of the error-signal generator; and, since the error-signal generator tends to line up with the sun, the spectrograph is brought into alignment with the sun.

Automatic Search

In addition to the simple tracking function, the sun follower automatically searches for the sun in the azimuth plane when energized at the start of the rocket's flight and

will do so automatically if it loses the sun during the flight. The search rate is 70 rpm relative to the rocket in a clockwise direction.

Since the rate of search must be greater than any anticipated rocket spin velocity, the rotational velocity of the sun follower relative to the sun may be high under some conditions. The stopping and locking-on requirements are severe. Under the worst possible condition, when the direction of search and the direction of spin are the same, net search velocities up to 120 rpm can be expected. Because of the limited field of view of the error-signal generator, it is necessary to stop the sun follower in less than an 80-degree sector so the tracking unit can take over. This amounts to a deceleration of approximately 600 rpm per second. A velocity-sensitive unit providing for such deceleration has been incorporated in the sun follower.

Since the vertical coverage of the error-signal generator includes the sun in its field of view under normal conditions, no added provision for rapid acceleration and deceleration is required in the elevation plane.

The sun follower also provides rocket-aspect data for telemetering. Since the error-signal generator tracks the sun in both azimuth and elevation, its instantaneous position with respect to the main body of the rocket is the same as the rocket's instantaneous position with respect to the sun. Potentiometers attached to the sun follower provide d-c voltages for telemetering the

rocket's attitude. In addition, the sun follower's tracking errors in azimuth and elevation are telemetered.

Rocket Installation

The first sun follower was installed in V-2 rocket No. 38 which was fired on April 19, 1948. The rocket's flight was off course and had to be terminated at an altitude of eighteen miles. The cycle of operation of the sun follower had not begun at that time. In hope of saving the sun follower, the ejection mechanism was actuated immediately following radio-fuel cutoff. Signal Corps motion pictures taken with the aid of a tracking telescope show that the sun follower was ejected properly. However, at the time of the ejection the rocket's velocity was 3,830 ft per sec and it is doubtful if the parachute withstood the shock of opening in the earth's atmosphere. No part of the sun follower has been recovered.

A simplified version of the sun follower is now being prepared for installation in the Venus and Viking rockets as well as in some of the few remaining V-2 rockets.

BIBLIOGRAPHY

- H. N. Newell Jr. and J. W. Stry, "Upper Atmosphere Research Report No. II," NRL Rpt. R-3030, Dec. 30, 1946.
- W. A. Baum, F. S. Johnson, J. J. Oberly, C. C. Rockwood, C. V. Strain and R. Tousey, *Phys. Rev.*, 70, p 781, 1946.
- E. Durand, J. J. Oberly and R. Tousey, *Phys. Rev.*, 71, p 827, 1947.
- E. Durand, J. J. Oberly and R. Tousey, Analysis of the First Rocket Ultraviolet Solar Spectra, *J. Astrophys.*, 109, p 1, 1949.
- H. L. Clark, "Upper Atmosphere Report No. IX," NRL Rpt. 3522, Aug. 11, 1949.

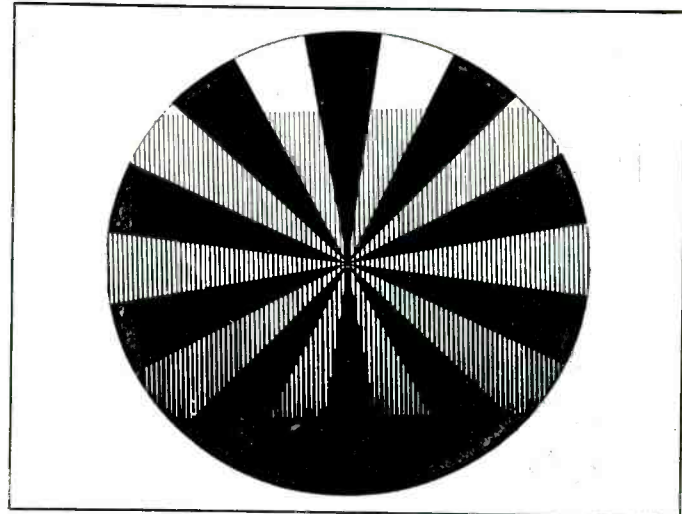

FIG. 4—Spokes of shutter provide 400-cps optical carrier as wedge shading modulates at 40 cps

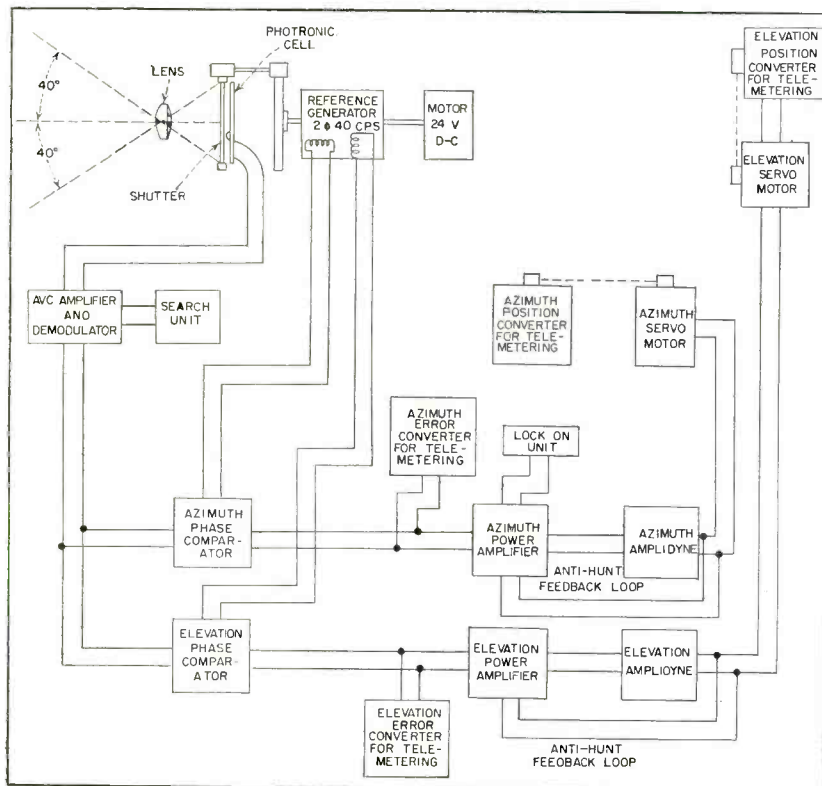

FIG. 3—Block diagram traces error signal from phototube generator to servo-drive motors

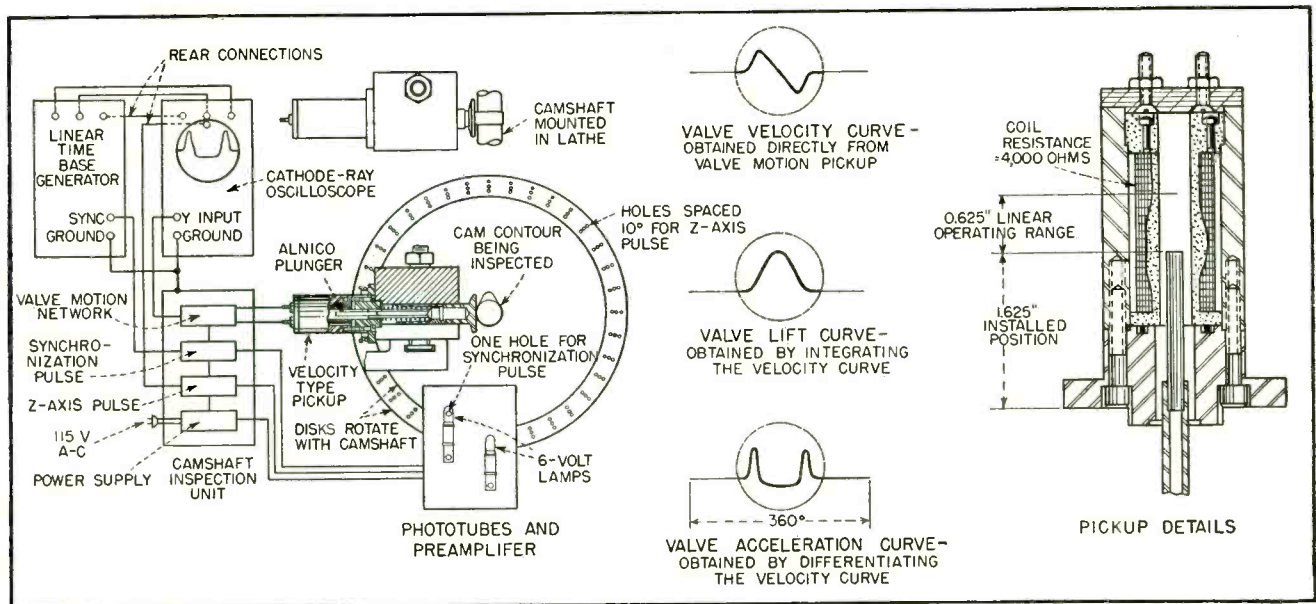

FIG. 1—Inspection fixture, associated electronic equipment, examples of the three types of curves obtained, and details of pickup coil whose output voltage varies linearly with velocity of the plunger inside

Electronic Inspection of ENGINE CAM CONTOURS

Cam pushes rod-shaped permanent magnet back and forth inside pickup coil to generate voltage proportional to velocity, for viewing on cathode-ray screen to reveal contour errors. System can also be used directly on engines to study valve motion at high speeds

THE CAMSHAFT LOBES that lift the valves of internal combustion engines must be accurately ground if good engine performance is to be obtained. In the production of camshafts, errors in profile can arise from factors such as wear in master cams and machinery, uneven grinding operations, lash and inertia. A cam lobe possessing a contour deviating noticeably from the theoretical can affect engine performance and cause failure of parts in the valve gear. This points to the need for cam contour inspection.

Inspection Methods

The conventional method of inspection involves using a suitable fixture to record the cam contour lift at intervals of one or two de-

By **MICHAEL G. TURKISH**

*Electrical Engineer
Eaton Manufacturing Co.
Detroit, Michigan*

grees. This method is sufficiently accurate for most inspection purposes as it provides data comparable to the design lift figures. However, small contour errors are not easily found without plotting a lift curve several times size or taking differences between adjacent lift figures and plotting the resulting data which will resemble a velocity curve. Also, differences of these difference figures can be taken to secure data which will resemble that of an acceleration curve.

Using inspection data in this manner gives erratic results since the fifth decimal place greatly

affects the acceleration curve. Furthermore, this method of checking a cam contour is time-consuming and is impractical for production testing except when done in rather infrequent intervals. When each lobe is to be inspected on a sixteen-lobe camshaft for an eight-cylinder engine, the inspection time can require from eight to thirty hours unless the fixture is suitably designed to handle production inspection. Small errors in indexing, errors in bearing supports for the camshaft and clearance errors in the tappet follower can affect the accuracy considerably.

An alternate method is to use a template for comparative purposes; this, however, is not suitable for any real accuracy. A modified form of the template method involves

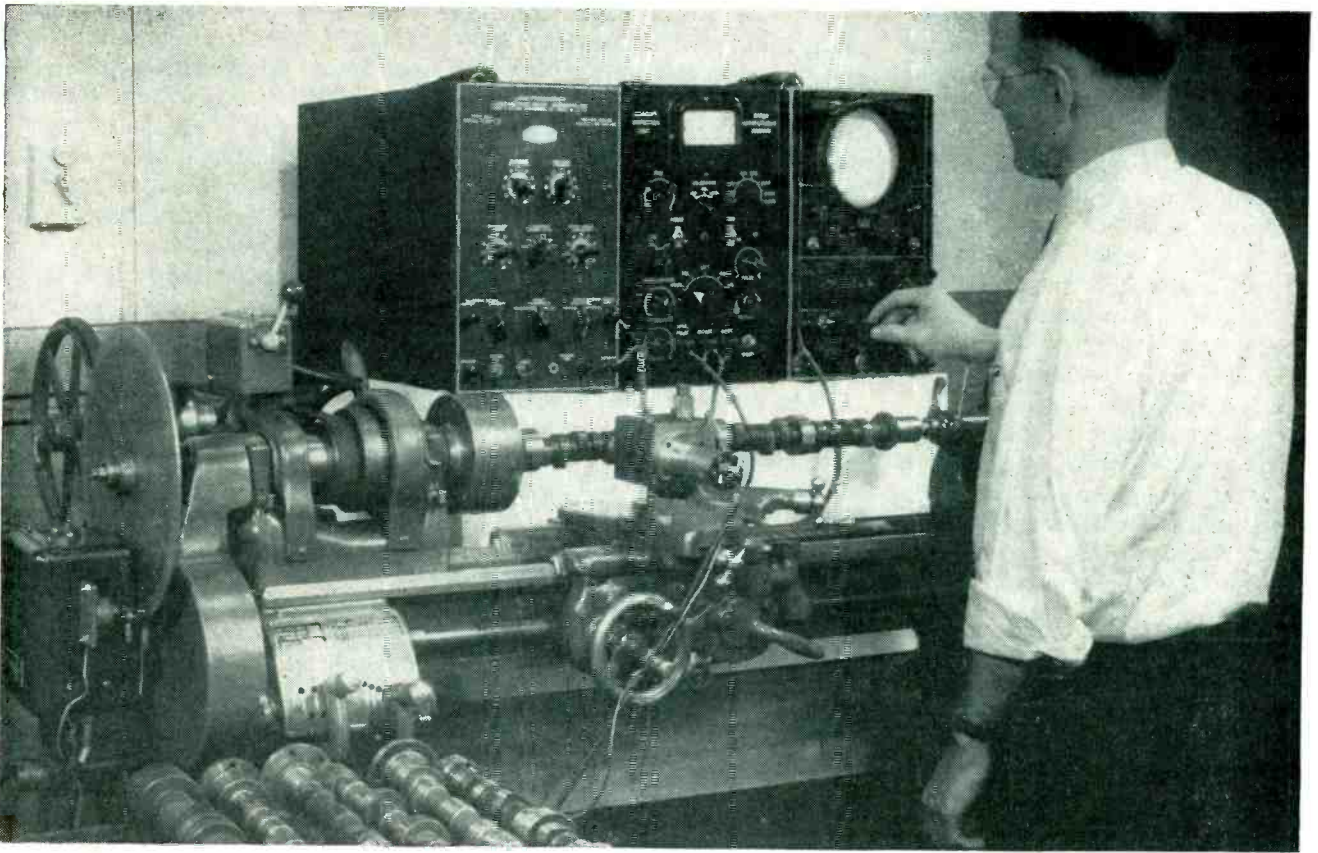

Cam contour inspection equipment installed on lathe. Operator watches curve on scope as tappet follower on lathe carriage is set on each cam lobe in turn. Disc at left end of lathe shaft has holes that pass light to phototubes in box below for generating sync pulses

using a magnifying comparator to cast an enlarged shadow of the profile on a ground glass screen. This is much more accurate, but still does not lend itself to production inspection.

In view of the shortcomings of the two established methods of inspection, the electronic method was evolved to obtain a rapid, accurate and more reliable method of determining the type of motion a particular cam will produce.

By using the electronic method of cam contour inspection it is possible to inspect each lobe in approximately one minute. All of the cam lobes of a camshaft can be inspected and photographed in only a fraction of an hour, once the equipment is set up. This method is equally suitable for supplementing production inspection and for cam contour development work.

Electronic Method

In the electronic method of inspection, the camshaft is mounted

in a lathe, and each cam contour is checked by observing curves that appear on the screen of a cathode-ray oscilloscope. The general arrangement of the equipment is shown in Fig. 1, along with the lift, velocity and acceleration curves that are selected at will with a three-position switch. Individual curves can thus be studied without going through the process of plotting them from data obtained by tedious micrometer measurements.

In actual inspection work the lift curve is not of much value as small errors are not apparent. The velocity curve reveals errors more readily, and is especially useful for checking the ramps provided at each end of the cam contour. The acceleration curve is best of all for critical cam contour inspection, as it reveals local irregularities even better than by calculation from lift figures measured to 0.0001 inch.

The camshaft to be inspected is mounted in a lathe and rotated at a uniform speed somewhere in the

range of 200 to 400 rpm. A tappet follower (flat, roller or shoe) is held against the cam lobe by a light spring to simulate the motion of a tappet in a valve gear. Attached to the follower is a small rod-shaped Alnico magnet that moves inside the pickup. The design of the pickup, also detailed in Fig. 1, is such as to give a high sensitivity factor along with linear response in its operating range.

The electronic equipment comprises a cam contour inspection unit, a 5-inch 208-B DuMont scope employing a blue screen for photographic purposes, and a 215 DuMont linear time-base generator. The scope has sufficient Y-axis gain to design a pickup for direct connection without an additional electronic amplifier. A more recent model of scope (DuMont 304-H) can be used without the separate generator as it has a sufficiently linear X-axis time base built-in.

The associated electronic circuit, shown in Fig. 2, provides two types

are easily made on the screen due to the sinusoidal waveform output from the pickup. To secure adequate sensitivity a higher speed is used for calibration than for actual cam contour inspection. Low speeds are desirable during cam contour inspection to keep inertia and spring loads to a minimum.

To find the sensitivity factor of the pickup coil, its output is fed through the cam contour inspection unit to the oscilloscope. The Y-axis gain is adjusted to give a certain amplitude on the screen, such as 2 inches overall. The selector switch is then set on CALIBRATION and the calibration switch is set on ACCELERATION. Finally, fine and coarse calibration controls are adjusted to give the same height as before on the screen. The reading of the voltmeter in millivolts, multiplied by the appropriate multiplication factor given on the coarse calibration control, is then used to establish the acceleration sensitivity factor of the pickup. This factor is used for all later adjustments, providing the pickup and magnet are not altered, the test speed is held at the pre-selected value, and the differentiating circuit is not altered. The velocity calibration is made in the same manner.

Inspection Results

The inspection fixture as built up employs a conventional lathe. The tappet follower can be a flat plate, roller, or curved shoe, and should be the same as the type normally used with the cam contour being inspected if accurate data are to be obtained for comparison with a theoretical curve. For purposes of magnifying errors appearing on the nose of the cam, a small roller follower may be used on a cam contour normally requiring a flat plate or large roller follower. In this instance, the wave forms will be of value for comparative purposes only in production testing and will have no direct relationship to theoretical curves.

At the adopted test speed of 226 rpm the maximum inertia load, when inspecting a high-acceleration cam, is about one pound. During testing a light oil (about SAE-10) is continually supplied to the cam lobe to eliminate any tendency of

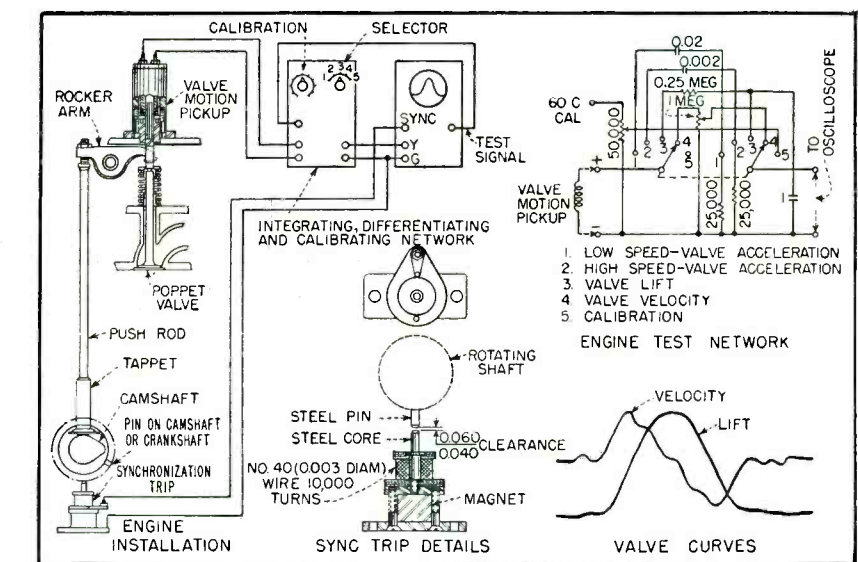

FIG. 5—Method of using equipment for checking operation of valves on an engine

the tappet follower to chatter. Inadequate lubrication produces rough and nonrepetitive curves.

Actual inspection is generally visual, but the curves on the screen can be photographed for closer study wherever desirable. A typical complete set of curves as photographed for study of velocity and acceleration is shown in Fig. 3. The multiple curves shown are obtained by multiple exposure, one for each line or pattern across the film. The film may be projected onto graph paper and traced for accurate comparison with a theoretical design curve, as shown in Fig. 4.

Engine Test Work

It is frequently desirable to observe valve motion directly on an internal combustion engine at relatively high speeds. Due to the flexibility of the various component parts, to a possible surge of the spring and perhaps to false motion in the valve gear, the resulting valve motion departs measurably from the theoretical motion which the cam is designed to produce. The same electronic instrumentation used for camshaft inspection may be advantageously used to observe valve motion at high speeds.

Arrangement of the equipment on an engine with overhead valves is shown in Fig. 5. Observations may be made with the engine motored with a dynamometer or under engine firing conditions. Typical

valve lift and velocity curves obtained with the engine delivering power at 3,600 rpm are also shown.

Due to the increased frequency of operation on an actual engine, it is necessary to alter the integrating and differentiating networks to secure accurate results. For this type of work the networks shown in Fig. 5 are used.

Synchronization of the oscilloscope may be obtained by using the simplified magnetic synchronization trip shown in detail in Fig. 5. This device consists of a coil of fine wire wound on a steel core and mounted on a permanent magnet. The motion of a steel pin past the core disturbs the magnetic flux passing through the coil for a short time interval to generate sufficient voltage to give synchronization. The high speed of operation produces a rapid change in flux so that a sufficiently high voltage is produced and no additional voltage amplification is required in the electronic equipment.

The use of this type of electronic test equipment for inspection purposes will assure that more manufactured cam contours will be closer to the preferred design. Its use on engine test work will reveal to the engine designer exactly how the valve gear is performing in an engine. The results will be longer life to the component parts of the valve gear and improved engine performance.

Curtain-Rod F-M Antenna

Body forms part of tunable horizontal loop exhibiting nearly omnidirectional characteristics. Design is easy to manufacture, install and adjust and withstands rough handling on the road and in the shop

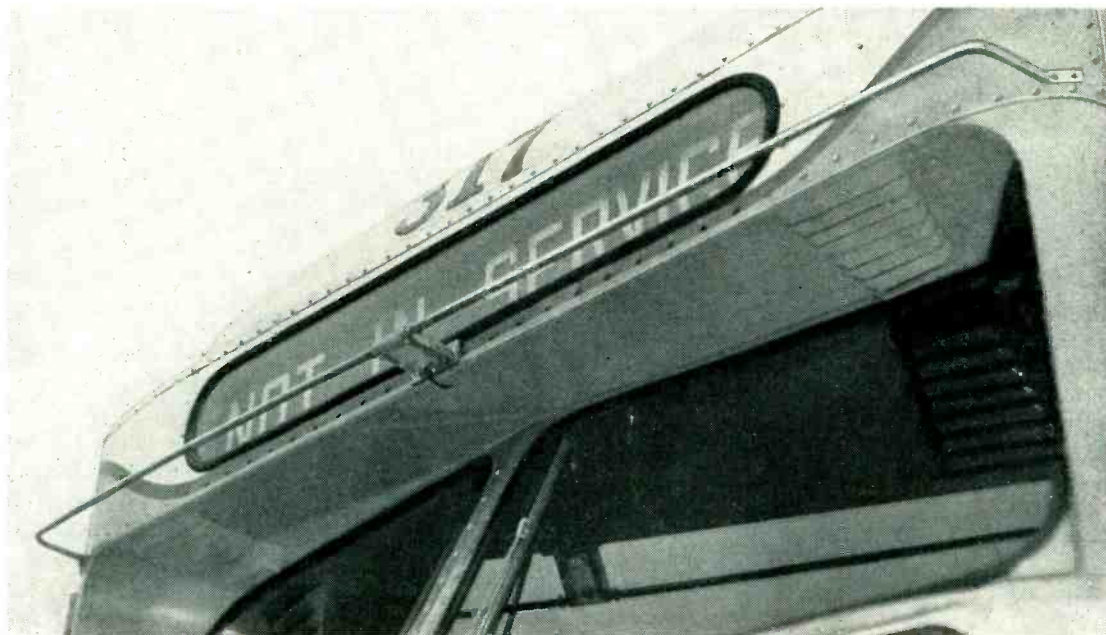

FIG. 1—Antenna mounted on front of bus between windshield and destination window

THE CURTAIN-ROD f-m antenna to be described is one component of a complete bus f-m receiver system which was developed for Transit Radio, Inc., Cincinnati, Ohio.¹

A satisfactory antenna for this application must meet the following requirements:

- (1) Receive horizontally-polarized waves.
- (2) The pattern in the horizontal plane should be reasonably omnidirectional.
- (3) A vswr on 50-ohm coaxial cable of 5 to 1 or better over a frequency band several times greater than the f-m channel width of 200 kc.
- (4) Mechanically strong to withstand the pressure of the large rotary brushes used to wash the bus, and to withstand the shocks caused by striking low-hanging tree branches during a run.

- (5) Easy to install, tune-up, and maintain by semi-skilled personnel.

Description

The antenna developed for this application is called a curtain-rod because of its physical appearance. Fig. 1 shows the antenna installed on the front of a bus between the windshield and destination window. It is a type of long, narrow, horizontal loop which is adaptable for mounting on the front or back of the bus. The loop is supported in the center by a metal U. This supporting U also serves as part of the tuned circuit that matches the balanced high impedance of the loop to the 50-ohm unbalanced coaxial cable which carries the signal to the receiver.

The antenna has five principal parts, four of which are shown in Fig. 2. The two long end elements are made of soft aluminum tubing

which can easily be bent, flattened and drilled. The center U has a mounting base and connecting lugs and is cast of brass. The tuning capacitor which is mounted and connected between the top ends of the U, is a 7-to-45 $\mu\mu\text{f}$ ceramic variable of the disc type. A Plexiglas cover for the center part of the U keeps rain, dust and tree branches away from the tuning capacitor and feed wires. An access hole is provided in the bottom of the cover so that the capacitor can be adjusted during routine maintenance without removing the cover. This hole is normally closed up with a metal snap-in button.

The cable that carries the signal from the antenna to the receiver is 50-ohm RG-58/U coaxial. It terminates at taps on the inner sides near the bottom of the U to provide a shunt-fed configuration.

Figure 3 shows how the optimum

for Buses

By LOUIS E. RABURN

Technical Supervisor, Antenna Section
Electronics Research, Inc.
Evansville, Indiana

vswr and frequency bandwidth for 5-to-1 vswr of the antenna installation shown in Fig. 1 vary throughout the frequency band 88 to 108 mc. (It is a conventional specification for receiving antennas that the mis-match loss may be as much as 2.5 db, corresponding to a vswr of 5 to 1). These curves show that the antenna can be adjusted for a vswr of less than 3 to 1 at any frequency in the band and that the bandwidth is more than 2 mc. Actual experience with a number of bus installations has indicated that this bandwidth provides a safe margin for reliable operation.

The first horizontal-plane patterns were measured using an actual bus installation tuned to f-m station WMLL on 94.7 mc. The bus was driven around in a small circle at a location in the middle of a level, clear field six miles from the station. The effective radiated power of the station was 4 kw and substantially line-of-sight propagation conditions prevailed. The strength of the input signal to the receiver was measured using a microammeter to indicate limiter-grid current for every 10-degree change of bus heading. The receiver meter had been previously calibrated in the laboratory with a signal generator. The measured pattern of receiver input signal voltage in millivolts versus bus heading is shown in Fig. 4. The strongest signal was received when the bus was headed toward the station but the extreme variation in the signal strength was only 7 db.

The same type of bus receiving antenna has also been used in several cities where the f-m station is still in the low band of 42-50 mc. In these cases, the antenna was modified by the addition of a 25- $\mu\mu\text{f}$ fixed capacitor in parallel with the variable tuning capacitor in the center U. The resulting antenna is not quite as well matched, but it still has a vswr of less than 5 to 1

throughout the band and gives very acceptable performance.

General Design Aspects

The length of the loop is nearly a half-wavelength and the loop is center-fed with a balanced structure. A lumped-circuit approximation helpful in understanding the antenna is shown in Fig. 5.

Each of the two end elements is approximately a quarter-wavelength long and during reception of a signal each element provides the center U with an induced loop voltage in series with a large resistance, R , and reactance, X . Voltage is the same from both elements and therefore a balanced voltage from a high-impedance source is applied across the top ends of the U. The U acts as a parallel L-C circuit balanced to ground; the base at the center of the U is actually grounded to the bus body.

The coaxial cable is tapped across the U near its base for best match to 50 ohms. The position of the tap varies with frequency, but a satisfactory compromise tap position can always be found. This location gives the vswr characteristics shown in Fig. 3.

More than a thousand of these antennas have been in service for several years without any major changes in the design. After the curtain-rod antenna had been developed it was learned that a 75-mc marker-beacon aircraft antenna having somewhat similar radiating elements was investigated by the Germans during World War II.²

The author wishes to credit John B. Caraway, Jr. of Electronics Research, Inc. for several invaluable suggestions and Richard W. Anderson for performing some of the measurements reported here.

REFERENCES

- (1) Car-Card Radio, *ELECTRONICS*, p 72, June 1948.
- (2) S. Zisler, Theory and Techniques of Antennas, Part I, p 24. Report F-TS-2222-RE available at Central Air Documents Office, Dayton, Ohio.

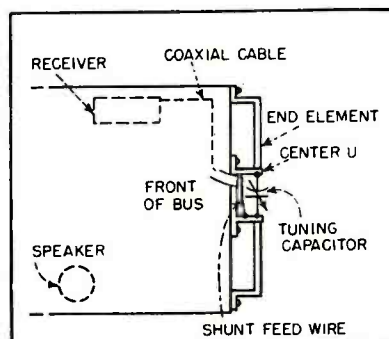

FIG. 2—Plan-view of antenna installation on front of bus

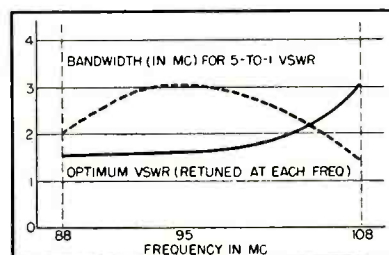

FIG. 3—Voltage-standing-wave ratio and bandwidth characteristics

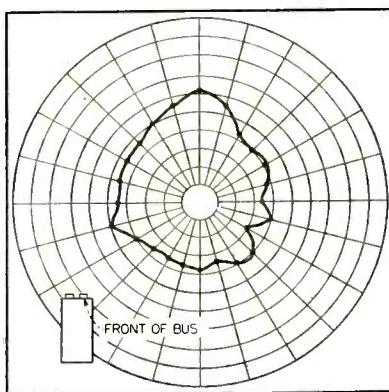

FIG. 4—Reception pattern of bus installation

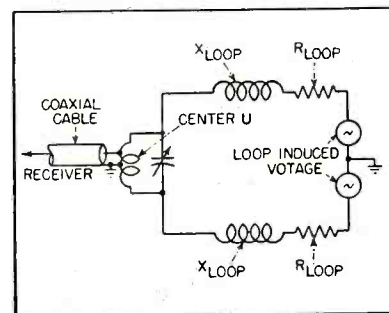
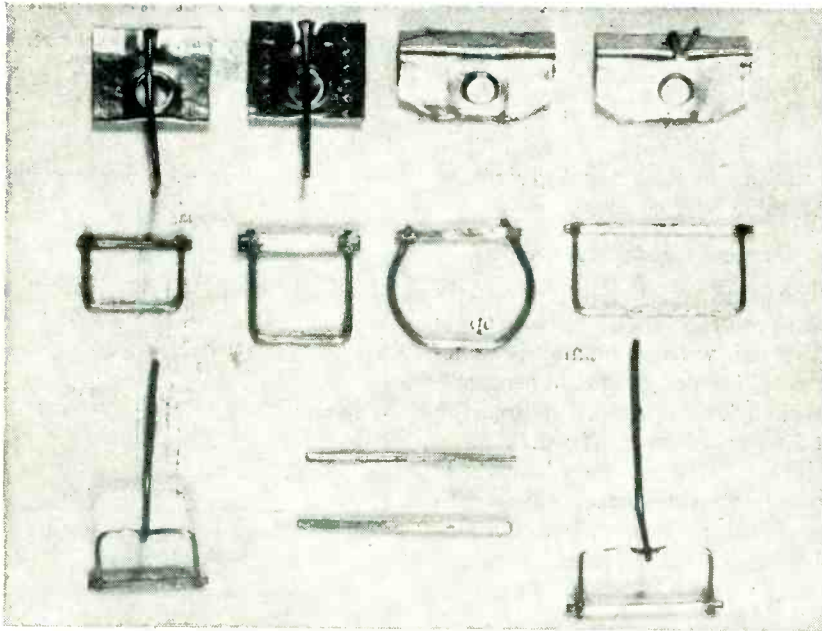

FIG. 5—Lumped circuit approximation of the antenna

GETTER MATERIALS



Typical Ba flash getters for glass bulbs (upper row) and getter strip assemblies

By **WERNER ESPE**

*Tesla National Works
Prague, Czechoslovakia*

MAX KNOLL

*Dept. of Electrical Engineering, Princeton University,
and RCA Laboratories Div., Princeton, N. J.*

and **MARSHALL P. WILDER**

*Tele-Radio, Inc.
Stamford, Conn.*

THE USE of getter materials is based on the ability of certain solids to collect free gases by adsorption, absorption or occlusion. This effect is widely utilized in the field of electronics to shorten the exhaust period and to improve and maintain a high vacuum or the purity of an atmosphere of noble gases.

Bulk getters are sheets or wires of gas-absorbing metals, which usually are heated for this purpose by mounting them on hot electrodes of the tube. In some cases the heating is accomplished by a separate heating source.

Coating getters are generally applied to those electrodes of vacuum tubes, which during service are maintained continuously at temperatures between 200 and 1,200 C. Such getters usually consist of non-volatile metal powders that are sin-

tered upon the electrode surfaces.

In the case of flash gettering, chemically active, comparatively volatile metals—mostly metals of the alkaline earth group—are evaporated by heating their supports at the conclusion of the pumping process. The metal vapor before and during condensation reacts instantaneously with all other than noble gaseous residues and forms on all cold parts of the tube, particularly on the tube walls, the so-called getter mirror. This surface, because of its large area, is capable of binding chemically or physically gases that are liberated during the life of the tube. With respect to the mechanism of gettering and the action of gases getter materials may be divided into two groups: corrosion type and solution type. From this aspect, barium (Ba) is the typical example

of chemical corrosion by gases and zirconium (Zr) an example of solution of gases in a metal. Corrosion takes place if the oxide film is porous and incoherent, thus not preventing further oxidation, which usually happens only if the volume of the oxide is smaller than that of the metal to be oxidized. In this case, the sorption of gas from the surrounding atmosphere can continue uninterruptedly. Oxides of the alkali and alkaline earth metals have less volume than the metal.

From a technical aspect the wide application of earth alkali metals for flashing getters in vacuum tubes is founded upon the fulfillment of the following requirements.

(1) During the standard degassing procedure at 400 C the getter should have low vapor pressure ($p < 10^{-2}$ mm Hg).

(2) The getter should be readily vaporized at its activation temperature. This temperature range must be high enough so that the getter may be readily degassed prior to the flashing; on the other hand, it must be sufficiently low to avoid the evaporating, melting or loosening of electrode metals. For nickel supports this establishes a temperature range of 600 to 1,000 C.

(3) After flashing, the getter deposit on the tube glass wall must have a negligibly low vapor pressure ($p < 10^{-7}$ mm Hg) assuming the operating temperature of the vacuum tube at 200 C.

(4) Between ambient and operating temperature the getter should be very active for all gases, especially oxygen. The oxide film created must be porous and incoherent in order that the gases may diffuse without hindrance into the interior of the getter mirror and may be absorbed also by getter molecules in the volume of the getter material.

for ELECTRON TUBES

The specific action and applicability of Ta, Cb, Zr, Th, Ti, Al, Mg, Ba and P as getters for vacuum tubes are shown. They can be formed as wires, sheets, tubes and tablets directly or indirectly heated; they may be powder coatings on hot electrodes; or they can be flashed

(5) The chemical compounds should be stable in order that during operating temperature or electron bombardment the absorbed gases are not expelled. For gas-filled tubes, the absorbed residual gas should not be replaced during operation by the filling gas, for example—Hg-vapor in tubes.

The first requirement is satisfied by all earth alkali metals. As seen from Fig. 1, Mg is near the border line, and cannot be used in tubes with high operating temperature because of the danger of migration of Mg atoms. Requirement 2 is met by all earth alkali metals but not by aluminum. Requirement 3 is met by all earth alkali metals with the exception of magnesium. The fourth requirement, with emphasis on activity, is met by all earth alkali metals with the exception of magnesium and aluminum. In a similar manner requirement of an incoherent oxide layer is not met by magnesium and aluminum. Requirement 5 (stable reactions) is met by all earth alkali metals but only up to a temperature of 200 C (regarding the oxides created even up to higher temperatures).

The materials Sr, Ba and Ca, are the most suitable for flash getters in high-vacuum electron tubes. Concerning the replacement of absorbed gases by mercury vapor, however, all earth alkali metals fail with the exception of magnesium, which is the reason that the latter metal is used in mercury tubes.

There are few quantitative data that permit a comparison of the getter-efficiency of different metals for different gases. Table I shows such a comparison for flashed deposits of Al, Mg, Th, U, mischmetal and Ba and the gases O₂, H₂, N₂, and CO₂. It exhibits Ba as the

most efficient getter among the metals investigated. The higher efficiency of diffuse deposits is due to their much larger surface, resulting from their finely divided state. This phenomenon, known as dispersal gettering is illustrated by the black Ba deposit.

The practical choice of the proper getter material is a function of factors other than efficiency alone. The broad use of high-efficiency flash getters requires considerations of insulation, interelectrode capacitance, contact potential and secondary emission of vacuum-tube electrodes and insulators, which often suggest their avoidance. On the other hand, Ba flash getters are preferred for oxide-coated cathodes because the Ba does not poison the cathodes and in some cases will improve the BaO cathodes. Judicious use of shields and proper positioning of the flash getters

avoids most of their disadvantages.

It has been known for a long time that almost all metals (after thorough degassing) are capable of adsorbing gases on their surfaces.

Tantalum

Certain metals are capable of incorporating gases, even noble gases, by solution in their bulk volume. The classical example is tantalum which, on account of this property, plays a predominant role in the construction of high-power transmitting tubes. After degassing in a high vacuum for several hours at a temperature of 1,600 to 2,000 C, tantalum is capable of absorbing gases in amounts up to several hundred times its own volume. The optimum gettering temperature for tantalum appears to be in the neighborhood of 1,000 C. At temperatures above 1,500 C, the gettering action is reversed. The maximum getter effect is secured, therefore, by dimensioning tantalum anodes so that during normal service the electrodes operate at red to yellow heat. Generally, the high price of tantalum sheets and wires limits the use of whole tantalum electrodes to particularly valuable tubes and suggests the coating of electrodes with tantalum powder. This is mostly performed by applying very fine tantalum powder on the surface of anode sheets in the finished assemblies. They are sintered together while simultaneously degassing these powders during the pumping operation by means of high-frequency heating or by electron bombardment. On account of the high degassing temperature required for tantalum, only molybdenum or tungsten is suitable as a base metal for tantalum powder. Tantalum should never be hydrogen-fired because of embrittlement

Table I—Comparison of Getter Efficiency for Metals and Gases

Getter	Gas	Efficiency (in microns of pressure)	
		Bright deposit	Diffuse deposit
Al	O ₂	7.5	38.6
	N ₂ , H ₂ , CO ₂	—	—
Mg	O ₂	20	202
	CO ₂ , N ₂ , H ₂	—	—
Th	O ₂	7.45	31.15
	H ₂	19.45	53.7
U	O ₂	10.56	9.26
	H ₂	8.9	21.5
Mischmetal	O ₂	21.2	50.9
	H ₂	46.1	63.9
	N ₂	3.18	16.1
	CO ₂	2.2	44.8
Ba	O ₂	15.2	45
	H ₂	87.2	73
	N ₂	9.5	36.1
	CO ₂	5.21	59.5

Getter efficiency is determined by the product of volume (1 liter) and pressure of gas cleaned up by 1 mg getter material. Diffuse deposits were obtained by flashing the getter in argon and consist of finely divided getter material.

and consequent destruction by this gas.

The main disadvantages of tantalum are the high material cost and the high temperature range required for proper degassing and subsequent gettering operation.

Columbium

During recent years columbium getter pellets have been introduced to the vacuum technique. These pellets are approximately three to five millimeters in diameter and one to three millimeters high, and consist of oxide-free columbium metal.

The getter pellets must occupy a position in the tube where they can be heated to a high temperature during exhaust by either high-frequency induction or electron bombardment. The position of the pellet must be such that the temperature is maintained by either radiation or electron bombardment at approximately 500 C. This temperature is not critical but must be above 400 and less than 900 C. A temperature of 1,650 C is needed to outgas columbium pellets because at this temperature occluded and absorbed gases are expelled and columbium oxide is volatilized. A temperature lower than 1,650 C will not accomplish this expulsion of columbium oxide. The outgassing time may vary from a period of five minutes to a somewhat longer time. The preferred manner for supporting the columbium getter pellet is to weld a molybdenum wire to it. The temperature of out-

gassing is too high for a nickel support but is in the proper range for molybdenum. Tungsten need not be used.

Zirconium

Zirconium has valuable gettering characteristics and has come into wide use during the past decade. It forms very stable solid solutions (or compounds) with such gases as O, N, CO and CO₂. Zirconium metal is cheaper than tantalum and requires somewhat lower operating temperatures. Zirconium is available either in solid metal form (sheets or wires) or it may be applied in the form of a powder to base metals (molybdenum) as described above. The proper outgassing temperature for zirconium lies between 1,000 and 1,700 C, which is attained by either direct or indirect heating of the zirconium metal or of the base metal to which zirconium metal or zirconium powder has been applied. Wherever it is deemed inadvisable to heat the getter material to this temperature range, an outgassing temperature of 700 C must be considered minimum for activating the surface of the zirconium getter. While zirconium is effective as a getter from about 400 C on, it is most active at temperatures up to 1,600 C if used, for example, on molybdenum and carbon anodes.

The solubility of H₂ in Zr at room temperature equals 1,500 times its own volume at 1 atmosphere. Sorp-

tion begins at 300 to 400 C and is completed at 500 C. As the temperature is increased, the metal frees H₂, but at 850 C the H₂ is again taken up during transition from α to β Zr. Above 850 C, H₂ is evolved. Sorption and desorption are reversible with decrease in temperature. Preliminary heating to a high temperature is a necessary condition for the sorption of H₂ at lower temperatures. During a rapid passage from a high temperature (above 1,200 C) to room temperature, a large amount of H₂ is quickly taken up.

Oxygen as well as N₂ dissolve homogeneously in Zr. When a Zr rod covered with a thick white oxide layer is heated in vacuum, the metallic luster reappears. Water vapor is cleaned up between 200 to 250 C. Care must be taken that a part of the Zr getter remains at a low temperature (approximately 400 C) during operation in order to bind the H₂, while another part must assume much higher temperatures (approximately 800 C) in order to absorb O₂, N₂ and other gases.

Zirconium metal in sheet form 0.002 to 0.005 inch thick is used on locations that can be properly outgassed and which operate in the temperature range indicated above. Very often zirconium sheets are mounted to grid shields, cathode supports, and other structures, which during operation attain a temperature of 600 to 800 C. In small tubes zirconium sheets, cylinders, or ribbons are used for cathode supports, grid supports and radiation shields. Zirconium wire of 0.005 to 0.020-inch diameter can be mounted for direct heating, being heated whenever absorption of gas is required, or it may be mounted for the same purpose by winding zirconium wire around Mo rods or other suitable structures.

Continuous gas absorbers such as that shown in Fig. 2 provide a support for the Zr wire and are operated from 350 to 1,700 C, for example, in x-ray tubes in series or in parallel with the filament (the temperature being adjusted by proper length of the wire). They have also been used for shortening the degassing time of electrode systems during pumping. Using a

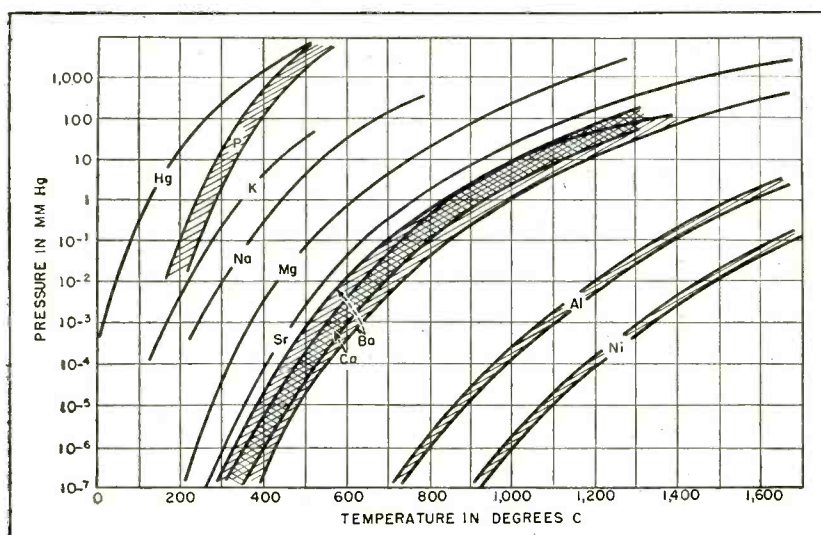

FIG. 1—Vapor pressure of metals used as flashing-type getters. Hg and Ni are included for comparison

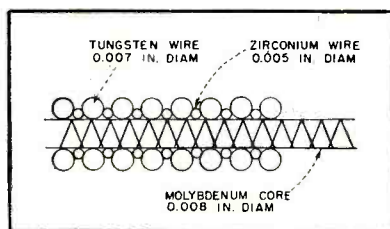

FIG. 2—Zirconium-wire assembly for continuously heated gas absorber

Zr wire spiral of fifteen turns on a 0.040-inch Mo mandrel, treated and outgassed for one hour at 1,700 C, a pressure of 5×10^{-6} mm Hg was reached in ten minutes instead of thirty minutes with the high vacuum pump alone. This auxiliary pumping getter can be used repeatedly even though exposed to atmospheric pressure between pumping cycles, no additional outgassing between cycles being required. In every case the Zr absorber maintained a higher vacuum at a considerably higher effective pumping speed than the 20-liter-per-second high-vacuum pump.

A convenient way of using zirconium is to spray the tube parts with fine zirconium powder. Such powders, of particle size between 1 and 8 microns, may be suspended in a temporary binder such as nitrocellulose dissolved in amyl acetate. For high voltage tubes a permanent binder such as colloidal silicic acid has been used with success. Such a binder has the further advantage of not giving off gaseous products during outgassing and operation. The amount of binder is usually two to five percent. This mixture is sprayed on the electrode parts, which in turn are fired in vacuum in order to remove the binder or to convert the binder to a stable compound. Nickel electrodes (preheated at 1,000 C, operating at 200 to 500 C), molybdenum electrodes (preheated at 1,300 C in vacuum and operating at 800 C) and graphite electrodes can be satisfactorily coated with such mixtures. Quantitative data on the sorption of different gases at different temperatures by powdered Zr are shown in Table II. Other methods of applying zirconium powder to electrodes have been reported, such as a suspension mixture consisting of paraffin, naphthalene, xylene and methanol or deposition of zirconium

powder by cataphoresis.

Zirconium hydride (ZrH_2) may also be applied to Mo, Ni, Fe or graphite anodes or grids as a paste, by spraying or cataphoretic precipitation, and reduced to pure Zr upon heating. This compound compared with pure Zr powder presents the advantage that at lower temperatures the zirconium is tied up and protected against oxidation or poisoning during seal-in and exhaust. Then as the temperature is raised, metallic zirconium is formed, liberating its hydrogen completely in vacuum at about 800 C. Thus, for coating on carbonized plates, which liberate much adsorbed gas during exhaust, zirconium hydride may be preferable to the pure metal since not only is the combined zirconium protected from the evolved gases but furthermore the hydrogen that it liberates at higher temperatures apparently reduces the last traces of adsorbed oxygen in the carbon layer.

Zirconium has been used successfully in high-power transmitting tubes, especially tubes having thoriated tungsten filaments, small microwave tubes and gaseous discharge tubes. Zirconium is inert to mercury vapor.

Stable solutions or compounds of Zr are formed with most gases including water vapor, with the exception of hydrogen.

The chief disadvantage of zirconium as a getter is that the optimum temperature for the sorption of hydrogen is too low for the effective cleanup of oxygen, nitrogen and the oxides of carbon. If, therefore, the zirconium-coated part is to operate at a temperature much in excess of 300 C, a supplementary lower temperature Zr getter or a getter of the barium or barium-magnesium type should be added to absorb the hydrogen. Whether this precaution is necessary or not depends upon the tube and the amount of water vapor or pure hydrogen found within it.

Thorium

During World War II, thorium, thorium alloys and mixtures of these with other getter materials were developed in Germany for use in vacuum tubes. Thorium metal is manufactured by reduction of ThO_2 ,

with Ca. Powdered Th is very pyrophoric; it is inflammable by mere friction. Electrode parts were coated with thorium powder by cataphoresis and heated for two to three hours in a vacuum furnace. For wires the coating was 5 to 10 microns thick and for sheets 1 to 2.5 mg per sq cm. The heating temperature is about 800 to 1,000 C for nickel and iron and 1,500 to 1,600 C for graphite electrodes. Considerable gas absorption is reported to occur around 200 C but especially in the range from 400 to 500 C. This getter is therefore suitable for power tubes and very small tubes with high anode temperatures. If the anode is covered with thorium powder its surface finish is rough, resulting in increased emissivity by blackening.

One alloy of thorium is the getter called Ceto, which comprises a 20-percent mischmetal, (chiefly cerium) and 80 percent thorium. This powder mixture is sintered at approximately 1,000 C, and the bars are milled to powder again. It is very inflammable. Ceto getter powder is transformed with amyl acetate into a paste that is applied to the tube electrodes in the amount of 15 to 25 mg powder per sq cm and then sintered upon the base metal in a vacuum furnace. The degassing temperature of the Ceto getter is 800 C and a marked getter action is exhibited from 80 to 130 C up, with an absorption maximum at 200 to 500 C.

Ceto getter material has a lower secondary emission than barium. It is used when it is desired to avoid or to reduce secondary emis-

Table II—Sorption of Gases by Powdered Zirconium

Gas	Temp C	Gas sorbed (cu cm \times mm Hg per mg Zr)
O ₂	25	0.38
	400	1.99
N ₂	500	0.11–1.0
	800	1.46
CO	25	0
	500	0.43
	800	3.65
CO ₂	25	0
	500	0.57
	800	3.04
H ₂	25	0.09
	350	13.33

sion that might arise from the use of Ba. It cannot be used above 600 C. Ceto bridges the gap between the low-temperature flashing getter such as Ba and the high-temperature non-volatile types (Th, Ta and Zr.) Pure thorium or compounds of Th and Zr are highly pyrophoric.

Titanium

A recent addition to bulk getter materials is titanium, which can be used either as bulk or as coating getter. It is not pyrophoric and its getter properties are good, besides being easy to form and machine. Blackening of the parts can be obtained by a short heating in air. At present titanium sheet is more expensive than zirconium per unit of gas absorbed.

Aluminum

Aluminum in its pure state is not used as a flash-getter, chiefly because its vapor pressure is too low (see Fig. 1). It vaporizes sufficiently only above 1,300 C, which is much too high for the conventional base metals like Ni. On the other hand, aluminum plated on Fe to a thickness of about 15 microns shows a considerable coating-getter effect for traces of O₂ being bound by the carbon content of Fe electrodes and released only slowly during the life of the tube. After heating at 700 to 800 C in vacuum, the aluminum forms a black compound with the Fe base (FeAl₃ or FeAl₅). This blackening increases the total emissivity to a level that is equal to or greater than that of carbonized Ni anodes. Such Al-plated sheet-iron has been widely used in Europe for anodes in receiving and amplifier tubes with oxide-coated cathodes.

The trade name for sheet iron plated with aluminum on both sides is P2-iron; plated with Al on one side and with Ni on the other—PN-iron.

Magnesium

Pure magnesium possesses many desirable properties for a getter material, such as availability in suitable forms, and being comparatively stable and volatile under vacuum at convenient temperatures around 500 C. Unfortunately, the gettering power of magnesium is

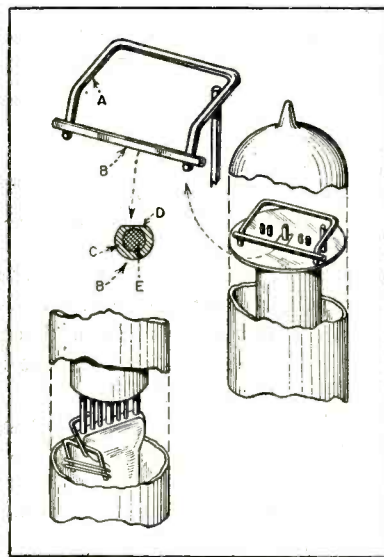

FIG. 3—Typical Kemet KIC getter mountings; A is nickel h-f induction loop, B getter strip, C iron sheath, D weakened zone to allow evaporation and E is 0.5 to 25-mg barium filling

not high because most gases are only physically absorbed. As a result, magnesium by itself is not used in high-vacuum tubes. The only evidence of its use is in Hg-vapor-filled rectifiers and in certain types as a grid coating powder to reduce secondary emission.

In order to obtain a material of greater stability and safety in use than pure magnesium, the so-called Formier getter was developed. It consists of aluminum-magnesium alloy powder (55 percent Al, 45 percent Mg) which is applied suspended in a nitrocellulose binder and applied to tube parts as a paint. On account of the limited gettering powers of magnesium, Formier is used only when other types of getters with higher evaporation temperatures must be avoided. Magnesium getters are difficult to degas, have little gas absorption up to temperatures of 175 C and absorb only oxygen. High vapor pressure precludes use in small tubes and at high operating temperatures.

Barium

The active ingredient of most flash getters is barium, which is used in combination with aluminum, magnesium, tantalum, thorium, strontium or calcium. The getter is attached to the electrodes in the form of a pellet, or more frequently, to a special metallic support within the tube as shown in

the top row of the accompanying photograph. It is mounted in such positions as to insure that the vapor stream produced is not splashed against such parts as the stem or the insulated lead-in wires. Shielding screens of metal, mica or ceramic materials are often provided to prevent this. The getter pellet must be attached to parts that during the pumping process may be readily heated to the evaporation temperature of the getter. This heating is performed by electron bombardment or, more frequently, by high-frequency induction from coils arranged outside the tube.

Flash getters of pure barium have the disadvantage that the unprotected barium reacts at room temperature with oxygen or with water vapor, thereby becoming inactive. This condition may be prevented by using: a protective layer or casing, alloys of Ba that are inert at room temperature or by generating the gettering material in the vacuum tube by a chemical reaction between stable Ba compounds and deoxidizing agents to form a reaction-type getter. Alloys of barium with magnesium and aluminum are relatively stable at room temperature and yield pure barium upon dispersal or flashing of the getter. The percentage of metals in standard alloys for getter tablets are: Ba 25, Mg 55, Al 20; Ba 37, Mg 37, Al 26; Ba 43, Mg 20, Al 37 (known by the trade name Kemet). The tablets are mounted on nickel flags of various shapes.

Barium-magnesium alloys yield very little Ba metal in the flashing and are, therefore, seldom used in modern high-vacuum tubes. Ba-Al getters provide much larger amounts of Ba metal, which accounts for their wider use. A common disadvantage of both types of alloys is their rapid rate of deterioration upon exposure to air and the necessity of vacuum packing.

Another commercial assembly is shown in Fig. 3. Other types comprise short pieces of iron, nickel and copper-clad barium wires to be mounted on a support of Ni-sheet, which can be high-frequency flashed at 900 to 1,100 C. Trade names of these materials are Feba, Niba and Cuba.

Several x-ray tubes of European

make use iron-clad barium (Feba) getter made in wire form, 2 mm diameter by 15 mm long. The getter is mounted within a miniature oven consisting of a ceramic tube into which the getter just fits. A tungsten spiral heater is wound on the outside of the ceramic tube. Care must be taken to avoid the possibility of migration of the barium to active tube elements. After sealing off the tube, the getter is flashed by heating the spiral.

Examples of the reaction type Ba getters are the reduction of BaO by Al to Ba (Alba getter) and of BaCO₃ or barium beryllate by Ta to Ba. In the case of BaCO₃, a tantalum wire heater is coated with a mixture of BaCO₃ and SrCO₃ (SrCO₃ prevents fusing of BaCO₃). At 800 to 1,100 C the carbonates dissociate to oxides and at 1,300 C the oxides react with Ta to form metallic Ba, whereby 40 percent of the theoretical Ba yield is obtained in the so-called Batalum process. Also barium beryllate (BaBeO₂) is stable in air and is used in a directly heated getter, shown in Fig. 4, formed in the shape of a trough from a 0.040 × 0.001 in. Ta ribbon, which holds approximately 2.5 mg of Ba and gives a Ba yield of 60 percent.

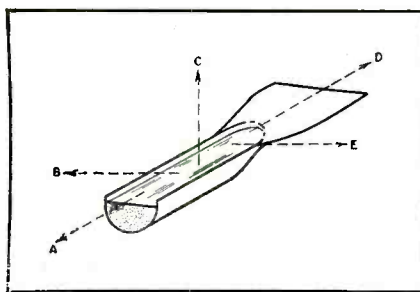

FIG. 4—Arrows indicate direction of barium metal evaporation from barium beryllate in tantalum trough

Another flashing-reaction-type getter is the so-called Bato getter, which is prepared by mixing an aluminum-barium alloy with iron oxide and thorium powder. Its purpose is to provide a source of heat in the getter pellet and in so doing aims at flashing Ba metal at a relatively low getter flag temperature. The source for the Ba is the Ba-Al alloy and the latent heat so derived forms an exothermic reaction between iron oxide and metallic thorium. The powder is formed into tablets, which are pressed into nickel cups and attached to special supporting members within the tube. Since it is important to store the Bato getter in a dry atmosphere, the getter flags are usually sealed into evacu-

ated ampoules or cans. After the pumping process, the getter is evaporated by high-frequency.

Flash getters are outgassed at temperatures between 600 and 700 C, usually by r-f heating from the outside of the tube, and flashed at temperatures between 900 and 1,300 C. The barium vapor condenses on the cold surface opposite the getter material, usually on the envelope of the tube. The appearance of the condensed getter deposit depends upon the vapor pressure in the tube at the time of flashing. If the getter is vaporized very slowly, the first barium atoms evaporated will absorb the gas present so that the remaining getter is deposited in a very high vacuum, exhibiting a shining mirror. If flashing is done very rapidly, however, the getter deposits in a rather high vapor pressure and the getter mirror will be discolored due to dispersion of the Ba. If vaporization is carried out in the inert atmosphere of a rare gas the condensed deposit will be black, resulting in a dispersal getter. This condition does not mean that the getter is contaminated, but merely that the deposit is finely divided and therefore absorbs light. Such deposits exhibit higher efficiency than the

Table III—Outgassing, Flashing and Operating Temperatures of Typical Getters

Material	Ta	Cb	Zr	Th	Ceto	Ba And Ba Reaction-Type Getters						Phosphorus
						Mg	Al-Mg	Compounds	Bato	Batalum	Ba-Beryllate	
Form of Application	bulk coating	bulk	bulk coating	coating	coating	flash	flash	flash	flash	flash	flash	flash
Form of Getter	sheet powder	pellets	sheet wire powder	powder	powder	ribbon wire	powder paint	metal-clad wire pellets	Ni-clad pellets	BaCO ₃ paint on Ta	BaBeO ₂ paint on Ta	powder suspension
Outgassing Preheating Temperature (deg C.)	1,600-2,000	1,650	700-1,300 (up to 1,700 in compound wires)	for metal base 800-1,000 for graphite 1,500-1,600	800-1,200	400	400	600-700	no ref	800-1,100	900-1,000	no ref
Flashing Temperature (deg C.)						500	no ref	900-1,300	750-800 (900)	1,200-1,300	1,300	>200
Operating Temperature (deg C.)	700-1,200	500	800 (up to 1,600 in compound wires)	400-500	200-500	absorbs gases only during flashing		20-200 max	20-200	20-200	20-200	100-200
Applications Reported	D, E, M	D, E	C, D, E, F, I, K, L, M, N	C, D	P	I, K	A, F	A, B, D, F, G, H, I, (L), N	D, M	A, F	A, F	O

A — Small receiving tubes	G — Cathode-ray tubes	N — Tubes with thoriated cathodes
B — Miniature tubes	H — Phototubes	O — Incandescent lamps
C — UHF tubes	I — Gaseous-discharge tubes	P — Vacuum tubes in which neither flashing getters nor the high temperatures necessary for Ta and Zr may be used
D — Medium-size transmitting tubes	K — Hg-vapor tubes	
E — High-power transmitting tubes	L — X-ray tubes	
F — Oxide-cathode tubes	M — High-power vacuum tubes	

bright deposits indicated in Table I.

Barium reacts with atmospheric gases such as oxygen, nitrogen and carbon dioxide at room temperature, as well as with hydrogen and carbon monoxide. This absorption at low temperature makes flash getters particularly valuable for tubes that do not attain high operating temperatures. If the volume of the vacuum tube is large, multiple getter strips or several getter pellets are employed.

Flash getters have the disadvantage that during flashing metallic vapor is produced, which may settle on insulating parts or build up a conducting layer on the glass envelope. Such layers may become charged during operation or represent interelectrode capacitance. Usually flash getters are inadvisable in high voltage tubes or in microwave tubes, the latter type having very close spacing and only short insulating surfaces. It should also be considered that the opaque mirror interferes with the cooling of electrodes by radiation. In high-voltage types like transmitting and x-ray tubes fast stray electrons may hit the mirror and evaporate sufficient getter material to cause a gas discharge followed by a short circuit and destruction of the tube.

Phosphorus

Phosphorus has a comparatively high vapor pressure (indicated in Fig. 1) and for this reason it is not used in radio transmitting, x-ray, or other high-vacuum discharge tubes. Inexpensive and simple to handle, it is used for high-vacuum and gas-filled lamps, especially for types of below 60 watts with voltages of 90 to 250 volts.

The outgassing, flashing and operating temperatures of typical phosphorus getters are given in Table III.

The authors wish to extend thanks to E. B. Steinberg (Remington-Rand) and E. A. Lederer (RCA) for assistance and suggestions in preparation of this manuscript.

BIBLIOGRAPHY

Condensed Papers and Books

S. Brunauer, "The Sorption of Gases and Vapors", Princeton 1942.
J. DeMent and H. C. Dake, "Rarer Metals", New York 1946.
S. Dushman, "Scientific Foundations of

Vacuum Technique", John Wiley and Sons, New York 1949.

W. Espe, New Getter Materials for the High Vacuum Technique, *Powder Metallurgy Bulletin*, p 100, Oct. 1948.

W. Espe and M. Knoll, "Materials of High Vacuum Technique", p 305, Ann Arbor 1944 (in German).

Faraday Society, London, "The Adsorption of Gases by Solids", p 447, Oxford 1932.

J. D. Fast, Metals as Getters, *Philips Tech. Rev.*, 5, p 217, 1940.

S. I. Gregg, "Adsorption of Gases by Solids", p 116, London 1934.

D. B. Langmuir and L. Malter, The Rate of Evaporation of Ta, *Phys. Rev.* 55, p 748, 1939.

M. Littmann, "Getterstoffe", Leipzig 1938.

I. W. McBain, "The Sorption of Gases and Vapours by Solids", London 1932.

A. E. Van Arkel, "Reine Metalle, Herstellung, Eigenschaften, Verwendung", Berlin 1939.

Gettering and Getters, *Light Metals*, p 34, Jan. 1944 and p 77, Feb. 1944.

J. S. Harrison, Production and Use of Getters and Materials in German Radio Valves, Thermionic Devices and Electric Lamps, B. I. O. S., Final Report No. 1834, London 1948.

Gettering by Evaporated Metals and Alloys

G. Ahrens, Cerium, *Mod. Metals*, p 20, Sept. 1945.

M. R. Andrews and J. S. Bacon, The Comparison of Certain Commercial Getters, *J. Am. Chem. Soc.*, 53, p 1,674, 1931.

M. Benjamin, C. W. Cosgrove and G. W. Warren, Modern Receiving Valves; Design and Manufacture, *J. Inst. El. Eng.*, 80, p 421, 1937.

J. E. DeGraff and H. C. Hamaker, The Sorption of Gases by Ba, *Physics*, 9, p 297, 1942.

S. Dushman, Recent Advances in the Production and Measurement of High Vacuum, *Journ. Frank. Inst.*, 211, p 689, 1931.

L. F. Ehrke and C. M. Slack, An Investigation into the Gettering Powers of Various Metals for the Gases H₂, O₂, N₂, CO₂ and Air, *Journ. Appl. Phys.*, 11, p 129, Feb. 1940.

G. Haase, Die Getterwirkung duenner Ba Filme bei tiefen Drucken, *Zeit. f. ang. Physik*, 2, p 188, 1950.

G. L. Hunt, Telefunken Metal Ceramic Radio Valves, B. I. O. S. Final Report 30, London 1945 (Dept. of Commerce, P. B. 18901).

G. W. Johnson, W. H. Hane and P. A. Anderson, A Quantitative Study of the Clean Up of H₂ by Ba, *Phys. Rev.*, 56, p 852A, 1939.

Getters and Gettering Methods for Electronic Tubes, Kemet Labs, 1947.

E. A. Lederer and C. H. Wamsley, Baterialum, a Ba Getter for Metal Tubes, *RCA Review*, p 117, 1937.

E. A. Lederer and C. H. Wamsley, Recent Advances in Ba Getter Technique, *RCA Review*, p 310, Jan. 1940.

A. L. Reimann, The Clean Up of Various Gases by Mg, Ca and Ba, *Phil. Mag.*, 16, p 673, 1933 and 18, p 1,117, 1934.

N. W. Robinson, Rugged Valves and Mechanical Tests for Valves and Components, B. I. O. S. Final Report 501, London 1945.

C. C. Van Voorhis, A. G. Shenstone and A. W. Pike, Purification of Inert Gas with Mischmetal, *Rev. Sci. Inst.*, 5, p 367, 1934.

R. Wild, Les Getters et leur Emplois, *LeVide*, 2, p 252, 1947.

Gettering by Solid Metals and Alloys

C. I. Bradford, J. P. Catlin and E. L. Wemple, Properties of Wrought Commercially Pure Titanium Prepared by Arc Melting and Casting, *Metal Progress*, 55, p 348, 1949.

I. E. Campbell and others, The Preparation and Properties of Pure Ti, *Journ. Electrochem. Soc.*, 93, p 271, 1948.

W. Daellenbach, Grossgleichrichter ohne Vakuumpumpe, *Elektrotechnische Zeitschrift*, 55, p 85, 1934.

R. S. Dean, and B. Silkes, Metallic Titanium and Its Alloys, U. S. Dept. Int., Bur. of Mines Information Circular 7381, p 38, Nov. 1946.

I. H. DeBoer and J. D. Fast, The α — β Transition in Zr in the Presence of H₂, *Rec. Trav. Chim.*, 55, p 350 and P 459, 1936.

I. H. DeBoer and J. D. Fast, Electrolysis of Solid Solutions of Oxygen in Metallic Zr, *Rec. Trav. Chim.*, 59, p 161, 1940.

I. H. DeBoer and J. D. Fast, Zr: I: Z. *An. Chemie*, 153, p 1, 1926 and 187, p 177, 1930.

W. Deck, The Adsorption of Gases by

Steel Walls of a Vacuum Discharge Apparatus and Its Bearing on the Life of Pumpless Mutators, *EBC Review*, 29, p 202, Aug. 1942.

E. I. du Pont de Nemours, Inc., Titanium Metal, *ELECTRONICS*, 22, p 207, March 1949.

W. Espe, Platovane zelezko jako nový material vakuove techniky, *Slaboproudny Obzor*, 11, No. 2, p 31, 1950.

W. Espe, Metalicke Thorium, nový zaimavy material techniky vakua, *Slaboproudny Obzor*, 11, No. 5, 1950.

W. Espe and V. Kratochvil, Titan-kov blitzke budoucnosti, *Slaboproudny Obzor*, 11, 1950.

G. A. Espersen, Zr for Electron Tubes, *Footprints*, 18, No. 1, p 3, 1946.

Fansteel Metallurgical Corp., Information for Use of Columbian Getter Pellets, Chicago.

Fansteel Metallurgical Corp., Columbium; Technical Information, Chicago 1946.

Fansteel Metallurgical Corp., Tantalum; Technical Information, Data Bulletin Ta 500, Chicago.

J. D. Fast, Ductile Shaping of Zirconium and Titanium, *Metalwiss.*, 17, p 453, 1938.

J. D. Fast, Zirconium, *Footprints* on Chemicals, metals, alloys and ores, 10, p 1, Dec. 1937 and 13, p 22, 1940.

J. D. Fast, Zirconium and Its Compounds with a High Melting Point, *Philips Tech. Rev.*, 3, p 345, 1938.

H. W. Gillet, Some Features of Ductile Zirconium and Titanium, *Footprints*, 13, p 1, 1940.

A. Greenwood, Titanium, Some Properties and Applications, *Metallurgia*, 36, No. 211, 1947.

W. G. Guldner and L. A. Wooten, Reactions of Zr with Gases at Low Pressure, *Journ. Electrochem. Soc.*, 93, p 223, 1948.

S. Hukagawa and J. Nambo, Absorption Properties of Metallic Zr and its Application to Electron Tubes, *Electrotech. Journ.* (Japan) 5, p 27, 1941.

W. J. Kroll and A. W. Schlechten, Survey of Literature on the Metallurgy of Zr, Bureau of Mines Information Circular No. 7341, 1946.

W. J. Kroll and A. W. Schlechten, Titanium and Zirconium—Two Metals of the Future, *Metal Industry*, 69, p 319, 1946.

O. Kubaschewski, Die Loeslichkeit von Gasen in Metallen, *Zeit. f. Elektrochemie*, 44, p 152, 1938.

W. C. Lilliendahl and others, The Quantitative Evaluation of O₂ in Zr, *Journ. Electrochem. Soc.*, 93, p 235, 1948.

J. R. Long, The Consolidation of Titanium Powder by Sheath Rolling, *Metal Progress*, 55, p 191, 1949.

J. W. Marden and M. N. Rich, Investigations of Zirconium, *Ind. Eng. Chem.*, 12, No. 7, p 651, 1920 and Bureau of Mines Bulletin 186, Mineral Technology 25, 1921.

W. C. Michels and S. Wilford, The Physical Properties of Titanium, *Journ. Appl. Phys.*, 20, p 1,223, 1949.

A. L. Reimann and C. K. Granz, Some High Temperature Properties of Niobium, *Phil. Mag.*, p 34, 1936.

E. R. Owen, Telefunken Special Materials for Radio Valves, B.I.O.S. Final Report 276, London 1945 (Dept. of Commerce, P. B. 27712).

M. Pirani, Ta und H₂, *Zeit. f. Elektrochemie*, 11, p 555, 1905.

O. C. Raiston, and F. J. Cservenyak, Potential Uses of Titanium Metal, *Ind. Eng. Chem.*, 42, p 214, 1950.

A. N. Rogers, Use of Zr in the Vacuum Tube, *Trans. Electrochem. Soc.* 88, p 297, 1945.

O. W. Simmons and others, Arc Melting of Titanium, *Metal Progress*, 55, p 197, 1949.

I. B. Sutton and T. D. McKinley, Induction Melting of Titanium in Graphite, *Metal Progress*, 55, p 195, 1949.

E. Wainer, Technology of Zr and Ti and their Compounds, *Ceramic Age*, 48, p 198, Nov. 1946.

F. S. Wartmann, Production of Titanium Powder by the Bureau of Mines, *Metal Progress*, 55, p 188, 1949.

E. Wedekind, Ueber die Darstellung des sog. kristallisierten Zr im el. Ofen, *Zeit. f. Elektrochemie*, 10, p 331, 1904.

L. V. Whitney, Temperature Scale of Cb, Th, Rh, Mo at 0.667 μ , *Phys. Rev.*, 48, p 458, 1935.

Gettering by Phosphorus

W. J. Bartlett, Chemistry in Incandescent Lamp Manufacture, *Ind. Eng. Chem.*, 21, p 970, 1929.

S. Dushman, Methods of Production and Measurement of High Vacuum, Part IX, Physical Chemical Methods, *G. E. Rev.*, 24, p 669, 1921.

Aircraft Ignition Tester

One set of spark plugs in an engine equipped with a dual ignition system is used as ionization detector to determine if the active set is firing properly. The drop in potential across the detector plug is sensed by an amplifier and neon-lamp indicator for each cylinder to give a dynamic indication on the ground

By **W. M. BAUER*** and **L. G. SANDS***

*Assoc. Prof. of Electronics Eng.
U. S. Naval Postgraduate School
Annapolis, Md.*

*Industrial Div.
Philco Corp.
Philadelphia, Pa.*

OPERATION of the ignition tester to be described depends upon the fact that an aircraft dual-ignition system includes two sets of spark plugs. Each cylinder has two plugs, connected to associated magnetos by a cable harness as shown in Fig. 1. When the engine is operating on one of the magnetos, the spark plugs of the other magneto system can be used as detector plugs to determine if the other spark plug in the same cylinder is firing properly.

Testing is accomplished by applying a fairly high voltage across the detector plug. When flame strikes the electrodes as the cylinder fires, ionization conductivity of the combustion gases permits current to flow and the potential across the detector plug drops.

This drop in potential across the detector plug is used to flash a neon lamp by means of an electronic circuit.

The basic circuit of the ignition tester is shown in Fig. 2. A potential of about 500 volts is applied to the detector plug through R_1 . The same voltage also charges C_1 through R_1 and R_2 . The grid of V_1 is normally positive, grid current being limited by R_3 . Neon lamp V_4 performs the double duty of voltage regulator and voltage level indicator.

The use of a spark plug as a detector of ionization has previously been used in studies of propagation of flames in cylinders. When an active plug fires, the combustion

flame at the detector plug greatly reduces the dielectric strength of the gap. When the gap of the detector plug becomes sufficiently conductive, the charged capacitor C_1 discharges through the detector plug. This discharge charges C_2 in opposition to its normal polarity and makes the grid of V_1 negative. A typical oscillogram of this variation in grid voltage, measured at the junction of C_1 and C_2 , is illustrated in Fig. 3. It will be noted that the grid voltage is driven from a positive value to a much greater negative value.

Swinging the grid of V_1 negative cuts off this triode with the result that its plate potential becomes much more positive, making the

grid of V_2 positive. Tube V_2 is normally biased to cutoff, so the positive swing causes V_2 to conduct and to light the neon indicator lamp V_3 . Flashing of V_3 indicates that the live spark plug has fired the cylinder's combustion charge.

After the voltage discharge through the detector plug, the grid voltage of V_1 relaxes toward its quiescent positive bias illustrated in Fig. 3, so that V_1 becomes conducting. It allows V_2 to return to its normally nonconducting state until the next ignition flame is detected by the detector plug. By providing suitable voltages across the detector plug and to the grid of V_1 , even a weak detection signal, owing to a very lean mixture, can

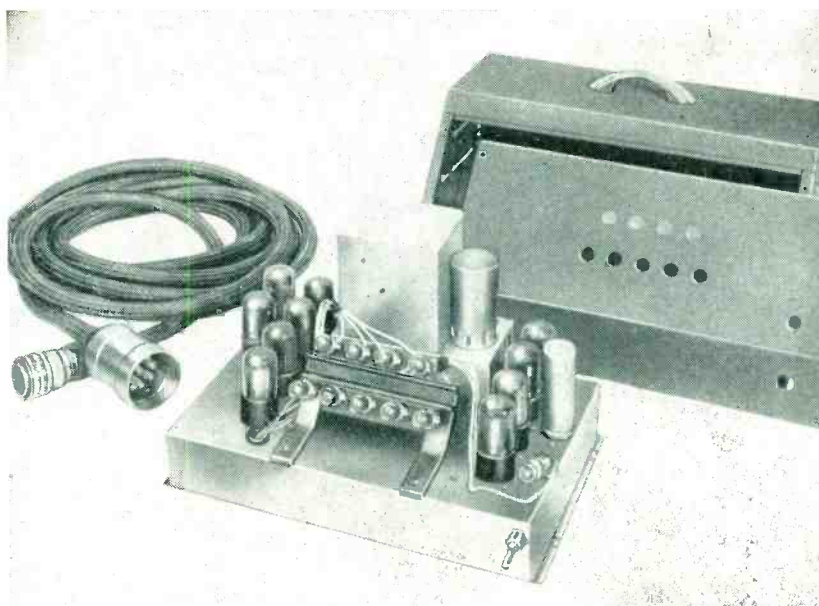

Complete tester, showing connecting cable from harness disconnect block. Two voltages are obtained from vibrator supply and additional vacuum-tube rectifier

* Formerly Curtiss-Wright Corp.

be relied upon to flash the indicating lamp V_3 brightly.

Bias Tube

The unusual location of the neon indicator lamp V_3 in the plate circuit of triode V_2 may be noted since the cathode is isolated from ground except during the conduction period of the lamp V_3 . By this means, a negative biasing battery or other inconvenient biasing method is avoided. Cutoff bias voltage is developed automatically by cathode emission and by electron collection by the plate. The cathode, being isolated from ground by the neon lamp, will raise itself to a positive potential by loss of electrons. With the grid grounded through R_3 , cutoff bias is obtained that keeps lamp V_3 dark until the positive grid signal is transmitted through capacitor C_3 .

In practical applications a separate electronic detector circuit is used for each cylinder. For a nine-cylinder engine, nine detector circuits with a total of nine firing indicator lamps and nine dual-triode tubes together with a power supply are used. This arrangement makes it possible to check all nine cylinders at once.

To connect such an ignition tester to an aircraft engine, disconnect junction blocks must be located in an accessible position somewhere along the high tension leads between the distributor and the ring manifold of the harness. In Fig. 1, the continuous ring manifold is shown with the disconnect

Spark Plug Faults Are Elusive

A plug that acts erratically in an engine when hot may test good when removed. Plugs that work perfectly under cruising conditions may go bad under takeoff conditions of higher compression and temperature. Many a crash has occurred that could have been avoided if ignition had been checked under load on the ground.

A conventional preventative is routine replacement of all spark plugs. However, it takes twelve man-hours to do the job on an 18-cylinder engine—with no assurance that new troubles have not been introduced. The ignition fault finder described in this article may go a long way toward improving maintenance

blocks located on top of this manifold in front of the engine. To attach the tester, one disconnect is opened and the tester cable is plugged into the manifold block. The plug from the magneto has all contacts grounded for protection.

For a nine-cylinder engine, nine individually shielded wires are connected to the tester from the receptacle on the ignition harness. Shielded leads are preferred in order to prevent crosstalk between the test leads in the cable to the tester. If unshielded leads are used, the mutual capacitance between leads permits induction of the firing signal from one lead to all the others. Such capacitance causes false flashing of the indicator lamps and greatly dissipates the strength of the initiating signal.

Another difficulty encountered was the severe interference from the mutual capacitance between the live ignition leads and the test ignition leads in the same harness. Reduction of interference voltage is accomplished by the capacitor

divider action of the comparatively large capacitance to ground of the test leads in the 20-foot cable connection to the tester. Further elimination of interference is accomplished by the integrator circuit defined by R_2 and C_2 . Tolerant of residual interference is made possible by operation of triode V_1 with positive bias that is too high for any negative interference peak to overcome.

Using the Tester

To test the ignition system of an aircraft engine, the engine may be run first on magneto 1. In this case, magneto 2 is cut out and the tester cable is connected to the receptacle at the disconnect block between the magneto and ignition harness in the circuit of magneto 2. With the engine running, firing of each cylinder is indicated by the flashing of its respective neon indicator lamp. The indicator lamp indicates definitely whether the associated cylinder is or is not firing, even if there is only occasional missing. The in-

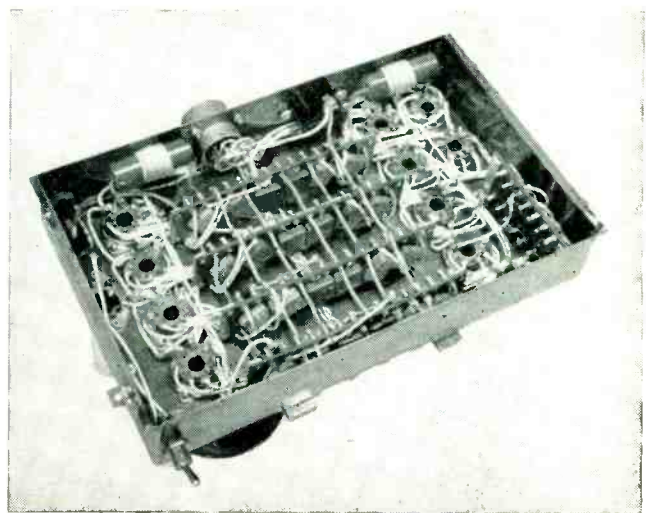
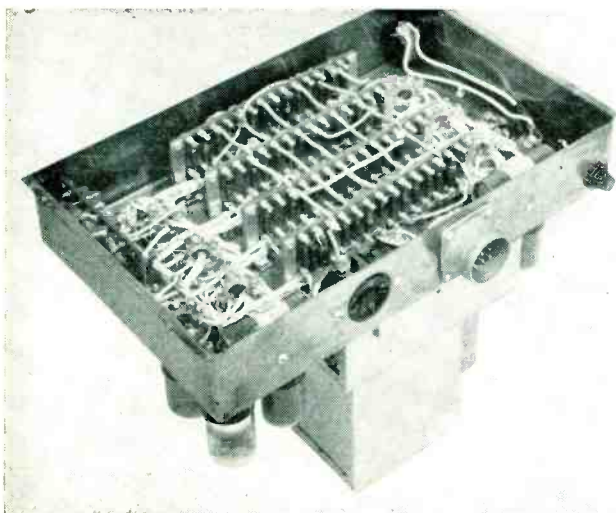

Underchassis views of the tester. Connection to the individual test plugs is made through the multiconductor plug shown at left

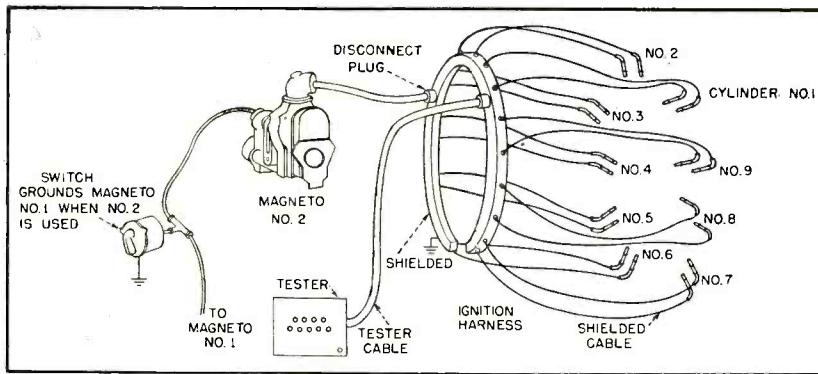

FIG. 1—Simplified detail of conventional ignition harness and method of attaching tester

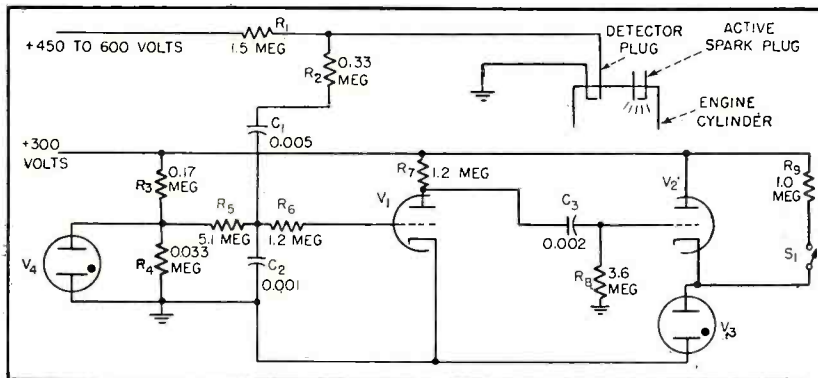

FIG. 2—Schematic of the test circuit. A similar channel is required for each cylinder

indication is simply the failure of the neon lamp to flash repeatedly so that an experienced operator is not required to interpret the lamp indications.

The ignition trouble is accordingly localized in the particular circuit which fails to fire the cylinder charge and in most cases the trouble can be cleared by replacement of the spark plug. If after such replacement, trouble still exists in this particular circuit, a standard harness and magneto tester may be used to locate the trouble in this circuit.

As a matter of convenience, the tester may be provided with a so-called memory switch (S_1 of Fig. 2) for each indicator circuit. If an indicator lamp shows faulty ignition, the memory switch may be closed so that the lamp will remain lighted after the ignition testing is completed.

Tests have shown that the detector spark plug need not itself be in perfect condition for detecting proper firing of the active plug on test. It has been found that fouled spark plugs will serve as ignition detectors until they are practically

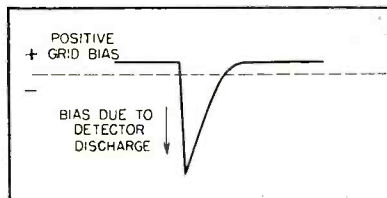

FIG. 3—Oscillogram of the voltage at the grid of tube V_1

shorted by a bridge of carbon across the electrodes of the spark plug. Even in case the testing apparatus falsely indicates faulty ignition of the active spark plug due to the detector plug being very badly fouled, the tester will still definitely indicate faulty ignition in that cylinder since the badly fouled plug would in this case fail to give satisfactory ignition.

Unique Performance

During a test demonstration of the ignition tester on a Wright G-200 engine, an indication of intermittent ignition in a cylinder where a new spark plug has been installed was indicated. Examination showed a mechanic's failure to make a proper connection to that spark plug. No other existing type of tester could have found this

trouble, nor could a complete replacement of an entire set of spark plugs preclude recurrence of the same trouble. The action of some questionable spark plugs was to go dead for a second or two, repeating the trouble after an interval of a few seconds to half a minute. Synchronized with the indication of the tester, there was an unmistakable change in sound and vibration of the engine. This type of an intermittently bad spark plug usually tests good on all other testers.

The presently used ignition harnesses are usually not equipped with disconnect blocks that would permit the ignition tester to be readily attached. Manufacturers have indicated a willingness to produce new harnesses with disconnects. Although this type has been developed and is being tested by airlines and engine manufacturers, present applications are confined largely to military uses.

The photograph shows an experimental model tester equipped with nine separate channels so that all cylinders of a nine-cylinder engine may be tested simultaneously. A type 6SN7GT dual-triode is used in each channel. Power is supplied from a vibrator pack and its associated rectifier tube since this particular model is intended for portable operation at an airport. The dual voltage output from the vibrator is obtained with a synchronous vibrator in addition to the novel use of a full-wave rectifier tube across the secondary of the vibrator transformer. The nine neon indicator lamps are visible through the openings in the front panel. The neon lamp to the far right is the voltage regulator V_2 referred to earlier in this paper. The glowing of this lamp indicates that the voltage applied from the power supply is sufficient for reliable operation of the ignition tester.

Test facilities for this development of the Curtiss-Wright Corporation Development Division were provided by the Wright Aeronautical Corporation ignition service and engineering departments, and by the Army School in Paterson, New Jersey. Grateful acknowledgment is also expressed for the helpful cooperation of A. C. Winter, Tony Munsell and J. G. Smith.

Video

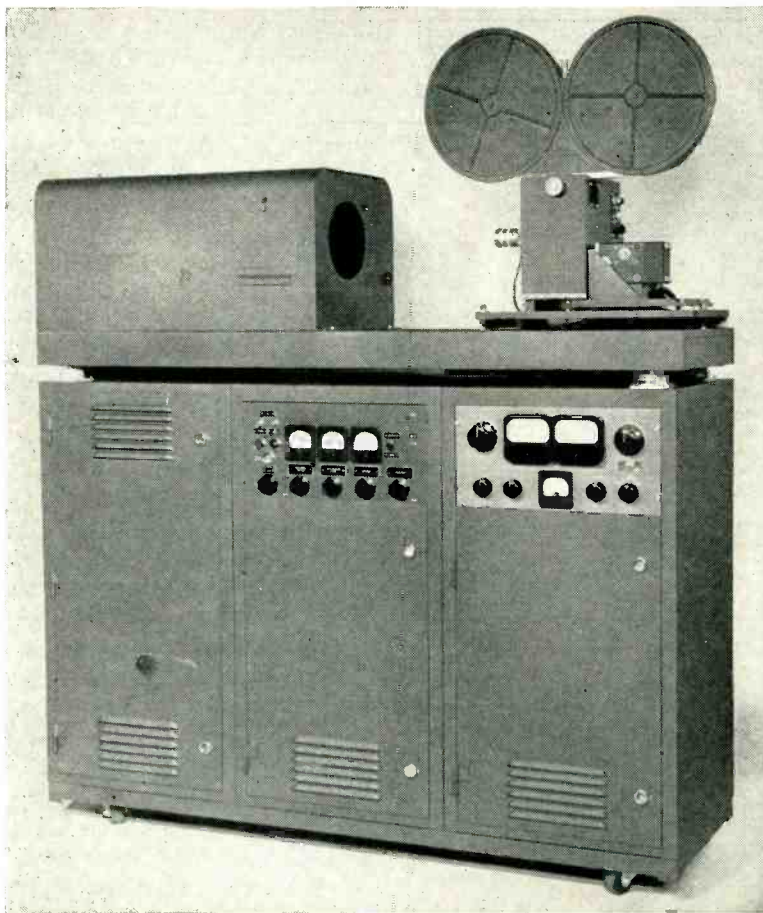

Complete video recording console. Hood at left covers the picture tube. Magazine of camera at right holds 1,200-foot film for 33 minutes of continuous recording

By **F. N. GILLETTE**, **G. W. KING** and **R. A. WHITE**

*Head, Apparatus
Development Section*

*Staff Member,
Circuit Development*

*Staff Member,
Camera Development*

*General Precision Laboratory, Inc.
Pleasantville, N. Y.*

VIDEO RECORDING, the transcription of televised material onto motion picture film from a cathode-ray tube, is an essential medium for long-distance network television. Used with existing relay facilities, video recording enables program presentation at the same hour in different time zones. In the absence of relay facilities, it provides the only means for network distribution of key station programs.

Current practice is to record on 16-mm film, at the motion picture standard rate of 24 frames per second. The recording camera is driven by a synchronous motor, operating from the local power line, so that the film exposure rate is synchronized to the local power line frequency. The television picture

rate, on the other hand, is necessarily synchronized to the power line frequency at the point of origin. If the camera has a conventional mechanical shutter, frequency difference between power lines causes recording difficulties in distant program pickup.

A new recording system, using an electronic shutter timed by electronic counting circuits, is entirely independent of the synchronizing frequency at the point of program origin. The equipment is self-contained in a single console. It includes picture and sound pickup circuits, the recording cathode-ray tube, a direct-reading video level monitor, a camera and a sound head.

The mechanical shutter of a conventional motion-picture camera

performs the cyclic tasks of starting, stopping and timing each film exposure. The electronic shutter is an assemblage of electronic circuit blocks which performs these same tasks. It differs from a mechanical shutter in the following respects:

The exposure is started and stopped by successively applying and blanking the picture on the face of the cathode-ray tube, rather than by intervention of a mechanical shutter blade.

The exposure is timed by counting the scanning lines which compose the television picture. Exposure of each film frame is terminated on completion of the 525th scanning line, regardless of whether or not the camera and the television synchronizing generator are in synchronism with each other. To achieve the same desirable objective with a mechanical shutter, two major variables must be controlled. These variables are the operating speed of the shutter and the angular blade width. The angular blade width is fixed in the camera design so that the time of shutter opening is 525 lines when the shutter is running at nominal operating speed. Departure from nominal speed during nonsynchronous operation causes line-count errors. During synchronous operation, momentary changes in power line frequency may cause line-count errors because of the inertia associated with the camera mechanism.

With either mechanical or electronic timing, the start of exposure must be properly phased in relation to the camera mechanism. Exposure should not start until film pulldown has been completed and the film has become stationary. With a mechanical shutter, this function is performed by the trailing edge of the shutter blade (or the leading edge of the shutter opening). With an electronic shutter, it is performed by a mechanical cycling disc which generates an electrical cycling pulse suitable for actuating the counting circuits.

The circuit blocks which compose

Program Recording

Independence of synchronizing frequency at the point of program origin is established by substitution of electronic circuits for the mechanical shutter of a motion-picture camera. Tubes are also employed for phosphor persistence compensation and gray-scale correction

the electronic shutter are shown in Fig. 1 together with a timing diagram.

The scanning method commonly used with either a mechanical or electronic shutter is shown in Fig. 2. Since four film frames are to be exposed during the period of five television frames, one television frame must be dropped out of every five. By utilizing the interlace feature of the television scan, the same result is obtained by dropping one-quarter frame out of every one and one-quarter. One complete field and two complementary portions of adjoining interlaced fields are photographed during a single shutter opening, the separate portions adding up to a single television frame.

Accurate shutter timing is essential for correct operation. The shutter not only blanks the picture during the film motion interval, but also times the exposure to allow exact completion of a single television picture on each film frame. It is this additional timing function that imposes the severe accuracy requirement. With correct shutter timing, the starting line of the first field and the ending line of the third field occupy adjoining positions in the raster. If the shutter remains open a trifle too long the film records several extra scanning lines, which appear on top of a completed frame as a bright horizontal strip.

Similarly, early shutter closure causes a dark horizontal strip. This strip, either light or dark, becomes an obvious exposure defect which is sometimes called a shutter bar. The region of the picture where shutter closure occurs is known as the join-up or splice.

These conventions apply to a positive print produced from a negative film. The light values re-

verse for a direct positive print.

It is characteristic of the scanning method that the join-ups of alternate frames have different positions. The two join-up locations are separated from each other by one-half the picture height. In Fig. 2, the intersections of the dotted lines with the vertical sawtooths indicate the join-ups. The phasing chosen places one join-up near the top of the first and third frames, and the other join-up near the bottom of the second and fourth frames. One join-up can be removed from the picture area by phasing the camera to place the join-up at the raster edge, but the other join-up lies within the picture area. The join-up locations remain stationary when the television and camera rates are synchronized to each other. Otherwise, they travel up or down, depending on the difference between rates. An invisible join-up is a necessity in either case, and shutter timing must be

correspondingly accurate. As an illustration of the degree of accuracy required, it may be noted that the edge of a mechanical shutter blade is hand-finished to almost micron dimensions in order to produce a satisfactory join-up. Even with this degree of accuracy, changes in the cyclic time base during nonsynchronous operation cause a shutter bar effect.

In the equipment illustrated, a shutter gate generator, rather than a timing circuit alone, blanks the cathode-ray tube during a portion of the film cycle. The phasing and duration of the shutter gate are established by several associated electronic circuits. One of these circuits opens the gate and starts the timing action as soon as pull-down of the preceding exposed frame has been completed. Another circuit times the exposure. A third circuit closes the gate. This combination of circuits forms an electronic shutter which replaces the

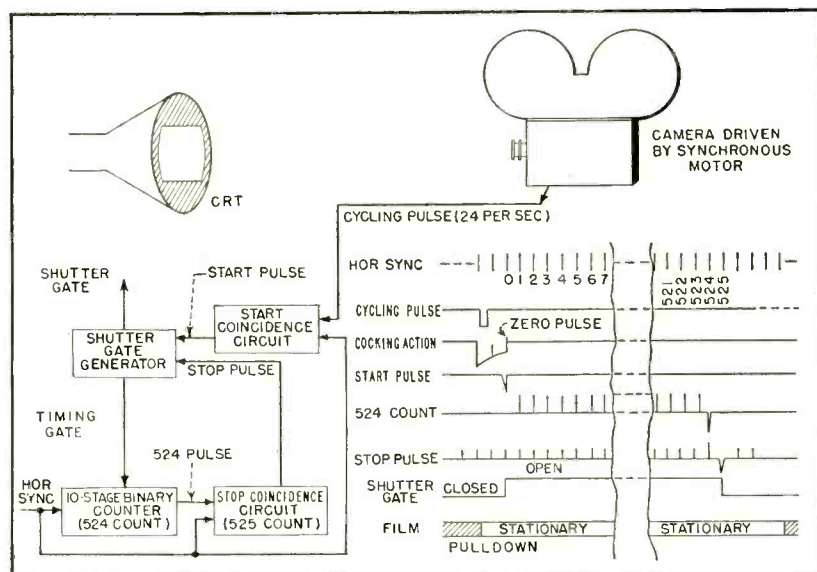

FIG. 1—Stages of the electronic shutter and illustration of line count timing. Exposure occurs when the shutter gate is open; the image on the crt is blanked when the shutter gate is closed

conventional mechanical shutter and affords greater inherent accuracy. The electronic shutter in the camera described has an inherent timing accuracy of better than one percent of a single horizontal line, or 0.5 microsecond, in either synchronous or nonsynchronous operation. The join-up reduces to a small line break in the unused margin of the raster, outside the picture area.

Since each television frame contains exactly 525 horizontal scanning lines, counting circuits may be used to time the film exposure. The counting circuits blank the recording cathode-ray tube when the correct number of horizontal lines has been scanned. Film exposure may start at any horizontal scanning line. Once started, the exposure continues to completion of the television frame, and then stops until triggered by a cycling pulse. In the camera, film pulldown starts after the exposure stops. On completion of pulldown, when the film has become stationary, the camera generates the cycling pulse and starts a new cycle.

Referring to Fig. 1, the cycling pulse, after amplification, actuates the start coincidence circuit. The pulse does not initiate the actual exposure, but merely cocks the circuit. A single horizontal synchronizing pulse then trips the circuit. This same synchronizing pulse, which may lie anywhere in the scanning cycle, becomes the start pulse which opens the shutter gate. Photography of the first scanning line commences with this pulse and continues as long as the shutter gate is open, the duration of the

shutter gate opening being determined entirely by the timing gate.

The timing gate resembles the shutter gate, but the starting edge is intentionally delayed so that the gate opens during the first scanning line, after passage of the zero pulse. With the timing gate open, each pulse following the start pulse trips an appropriate stage in the binary counter circuit until the 524th pulse trips the 10th stage. This, in turn, actuates the stop coincidence circuit, effectively cocking the circuit. The 525th horizontal synchronizing pulse then trips the circuit, closing both the shutter gate and the timing gate. The gates remain closed during the blanking interval. At the conclusion of this interval, the camera generates a new cycling pulse, exposure starts and the operation repeats itself.

Start Coincidence Circuit

Figure 3 shows the start coincidence circuit. Under static conditions, triode V_{2B} is strongly conducting and V_{2A} is biased to cutoff.

The negative cycling pulse from the camera passes through diode V_{2A} and arrives at the grid of V_{2B} as a strong negative pulse, sufficiently large to stop conduction in this triode section. The voltage at the plate of V_{2B} goes positive, carrying the grid of V_{2A} with it. Conduction thus transfers to V_{2A} . Meanwhile, the negative charge on V_{2B} grid starts leaking off through the 1-meg resistor.

The time constant in the grid circuit is such that V_{2B} grid can remain negative during the period of

several horizontal lines. (This is the cocking action illustrated in Fig. 1). While V_{2A} is conducting, the horizontal sync pulses are amplified in V_{2A} and appear as positive pulses on V_{2B} grid. Within the time of a few scanning lines, the negative potential on V_{2B} grid becomes so small that a particular pulse in the string of horizontal sync pulses overrides the negative potential on the grid of V_{2B} . This is the zero pulse, illustrated in Fig. 1, which causes transfer of conduction to V_{2B} . The voltage at the plate of V_{2B} falls abruptly from +150 volts to almost ground potential, giving rise to a large negative pulse which becomes the start pulse.

The stop coincidence circuit is shown in Fig. 4. It is similar to the start coincidence circuit, except for the use of direct coupling to V_{2B} grid. The 524 count (Fig. 1) from the 10-stage binary counter replaces the cycling pulse as one of the inputs. The other input, the string of horizontal sync pulses, remains the same. The output is the stop pulse. The stop coincidence circuit contributes the 525 count.

Shutter Gate Circuit

The heart of the shutter gate generator is shown in Fig. 5. The circuit is a symmetrical version of the start coincidence circuit, and may be recognized as a form of the scale-of-two counter. It has two stable positions, characterized by conduction of one or the other of the two triodes. If triode V_{1B} is conducting, a negative pulse applied through diode V_{3B} transfers conduction to triode V_{1A} . Conversely, if triode V_{1A} is conducting a negative pulse applied through diode V_{3A} transfers conduction to triode V_{1B} .

The counter stages also employ the same basic circuit. Ten counter stages are used, but only the first and last of these stages are shown in Fig. 6. The circuit configuration within each stage is identical. The circuit is known as the Higginbotham counter circuit.

Tube V_1 of the counter group inverts incoming positive horizontal pulses, providing the negative pulses required by the design of the counter circuit.

The negative sync pulses reach

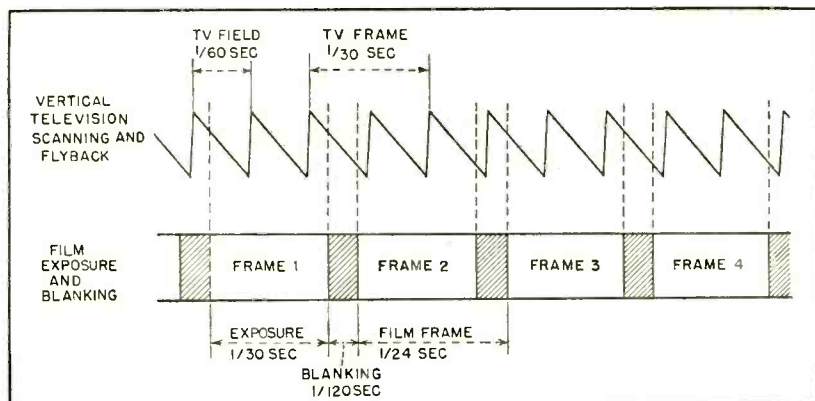

FIG. 2—Time relationships between television picture scan and film exposures

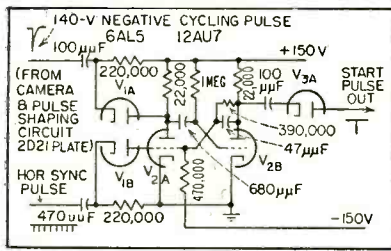

FIG. 3—Start coincidence circuit

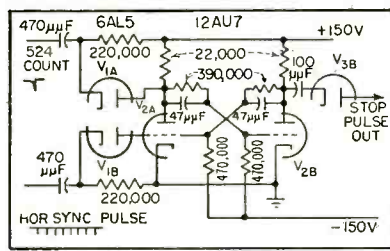

FIG. 4—Stop coincidence circuit

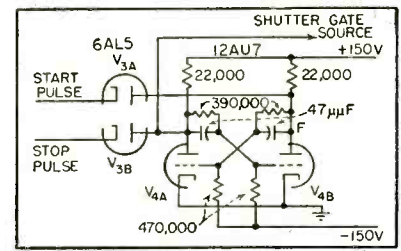

FIG. 5—Circuit of shutter gate generator

the first counter stage, V_3 , through a 100 μf capacitor and the pair of diodes in V_2 . The counter stage has two stable conditions, depending on whether the A or B triode section is conducting. Each successive pulse transfers conduction from one triode section to the other. Whenever conduction transfers from the A triode section to the B triode section, a 140-volt negative pulse is produced at the plate of the B triode section. This negative pulse reaches the next counter stage through another 100 μf capacitor and another pair of diodes. The action continues to the tenth stage.

Each counter stage contains two diode sections, only one of which is effective during any one pulse application. The plate of the other diode section stands at a negative potential with respect to its cathode, and hence the diode section does not conduct. Conduction transfers from one diode section to the other as the counter operates.

Counter Operation

Assume each stage in the counter is on when its A triode section is conducting, or off when its A triode section is nonconducting. The stage produces a pulse when it goes from on to off. It does not produce a pulse in going from off to on. The stage goes through a single reversal on receipt of a pulse from the preceding stage.

Suppose, then, that all stages are on as an initial condition. A single pulse entering the first stage trips all stages simultaneously, including the last stage. As the last stage swings from on to off it generates an output pulse. In effect, the circuit has counted one.

Suppose, instead, that all stages are off as an initial condition. The first incoming horizontal pulse swings the first stage on. The second incoming pulse swings the first

stage off; and the resulting counter pulse swings the second stage on. The second stage thus requires two incoming pulses for a single reversal. Similarly, the third stage requires 4 incoming pulses, and so on. The tenth stage swings from on to off, and generates an output pulse, only after 1,024 incoming horizontal pulses have been counted.

By turning certain stages on and the other stages off as an initial condition, any number from 1 to 1,024 can be counted. The 525 count imposed by current television standards is just beyond the limit of a 9-stage counter, and hence ten stages are used. The ten binary register switches are set to count 524 incoming pulses during each counter cycle. The 525 count is contributed by a separate stage associated with the stop coincidence circuit. In this way, the final critical count in each cycle is obtained directly from the associated horizontal pulse, with a minimum of intervening circuit elements.

The timing gate opens during the first scanning line, and remains open during the exposure cycle. Positive polarity corresponds to closed shutter. When the positive timing gate is applied to V_{z1} grid, the triode conducts heavily and the voltage at the plate falls to almost ground potential. This allows conduction through the reset diodes V_{11} to V_{z1} and the binary register switches. All counter stages are thus reset to their preselected on or off initial conditions during the blanking interval. The reset diodes do not conduct during the exposure interval, and hence do not affect the counter action.

A full frame of 525 lines is scanned during the exposure interval. One quarter frame is then dropped during the blanking interval to effect the 5:4 frame rate conversion. Under synchronous condi-

tions, the average blanking interval covers 131.25 lines. However, since the counting circuits do not recognize fractional lines, the actual number of lines dropped during successive blanking intervals is 131, 131, 131, 132, 131, 131, 131, 132 and so on. The difference on the fourth count is caused by an accumulation of fractional-line increments to the point where they start the blanking interval a whole line earlier. Each picture, meanwhile, scans to completion.

On the fourth count, the scan merely starts and ends one line higher. Since the beginning of the blanking interval is tied to the end of the picture, while the end of the blanking interval is tied to the cyclic rate of the camera, the blanking interval is not subject to rigid cyclic control. It can shrink several lines, or increase by any necessary amount. Because of this flexibility, the camera need not be locked to the frequency of the television signal. A full frame of 525 lines is photographed during each locally synchronous exposure cycle, and any short or over lines are dropped out during the blanking interval.

Camera Construction

In the camera, the most noticeable differences are the absence of the conventional mechanical shutter and the substitution of a cycling disc, outside of the picture light path, which generates the cycling pulse. This disc rotates at a constant speed of 24 turns per second (1,440 rpm) and passes a single light pulse during each revolution. It is phased so that the light pulse follows immediately after completion of film pull-down. A phototube with associated amplifying and pulse shaping circuits translates the light pulse into the electrical cycling pulse.

Figure 7 shows the amplifying

and pulse-shaping circuits. Triode V_{1A} and V_{1B} are a two-stage amplifier and V_2 is a gas tetrode used as a pulse regenerator. It is biased to cutoff in the absence of an input pulse. A positive pulse applied to the grid fires the tube and produces a single negative-going pulse at the plate. This pulse is fed to the start coincidence circuit.

Film pulldown must be accomplished in a relatively short time. The blanking interval of 1/120 second establishes the maximum time allowance for film pulldown, but only a portion of this interval may be utilized. The film must remain stationary during the initial portion of the blanking interval to allow for phosphor persistence effects in the recording cathode-ray tube.

Rate changes encountered in non-synchronous operation serve to further shorten the allowable pulldown time. During periods of increased camera rate or decreased television rate the end of the television frame intrudes on the beginning of the nominal blanking interval, and the start of film pulldown must be correspondingly delayed.

The camera uses a 3-to-1 skip movement in the intermittent mechanism. In effect, the mechanism operates at triple the normal speed and would pull the film at the rate of 72 frames per second if not for the fact that two out of three pulldown cycles are skipped. The film travels at normal rate of 24 frames per second, but pulldown is completed in $\frac{1}{3}$ the normal time. With

this fast action, pulldown can begin late in the blanking interval and can be completed before the next film exposure starts.

Practical Design Factors

It has been found that vibration, even in a small degree, may betray the location of the picture join-up. The subject for photography is a moving spot which traces successive patterns of evenly spaced lines. Vibration during film exposure displaces some lines with respect to others, causing line pairing and coarse line structure over portions of the film. Differences in line structure become particularly apparent at the join-up.

The effectiveness of vibration reduction measures employed can be gaged from the fact that close inspection of a recorded picture, projected on a 6 by 8-foot screen, reveals no evidence of vibration effects on either side of the join-up.

The deflection yoke design necessarily involves a compromise between good focus and low distortion. Perfect focus over the entire field can be attained at the expense of linearity, by accepting a certain amount of pincushion distortion. The approach used in this design was to strive for perfect focus over the field and to compensate for non-linearity by optical means. As a result, the scanning lines are clearly resolved over the entire tube face, while the departure from linearity at any part of the picture does not exceed the width of two scanning lines. The recorded film original

shows definite scanning line resolution in regions of low or medium density, at the corners as well as in the center.

A P11 phosphor is used in the recording cathode-ray tube. The major component of this phosphor's light output is in the blue region of the spectrum, where video recording films are most sensitive. This phosphor has a desirably high decay rate, the persistence illumination dropping to a very small percentage of initial illumination within the scanning time of a few lines.

Persistence illumination preserves each line for photographic exposure during an interval after scanning, and supplies an appreciable additional light contribution in relation to initial illumination. If the last line scanned in each frame is to contribute its full share of persistence illumination before film pulldown starts, the phosphor decay rate must be very high.

The P11 phosphor is almost entirely satisfactory in this respect, but has one shortcoming which seems to be common to all presently available phosphors. Complete extinction of low-level illumination requires several seconds. Residual illumination from this source causes a brightness difference between the first and last lines. Although the magnitude of the effect is small, the brightness difference can be quite apparent because these lines are adjacent in the recorded picture, and because the high contrast of the photographic film emphasizes any brightness difference.

Compensation is effected quite simply by using a sawtooth waveform which decreases the bias on the cathode-ray tube (increases brightness) as the exposure proceeds. The peak amplitude of the compensating sawtooth waveform is adjustable to meet different tube characteristics. The adjustment need be made only when a new tube is installed, and need not be repeated during the life of the tube.

Power-Law Amplifier

Gray scale rendition is improved by use of a power-law amplifier, a device which was originally developed for video recording, but which now offers promise

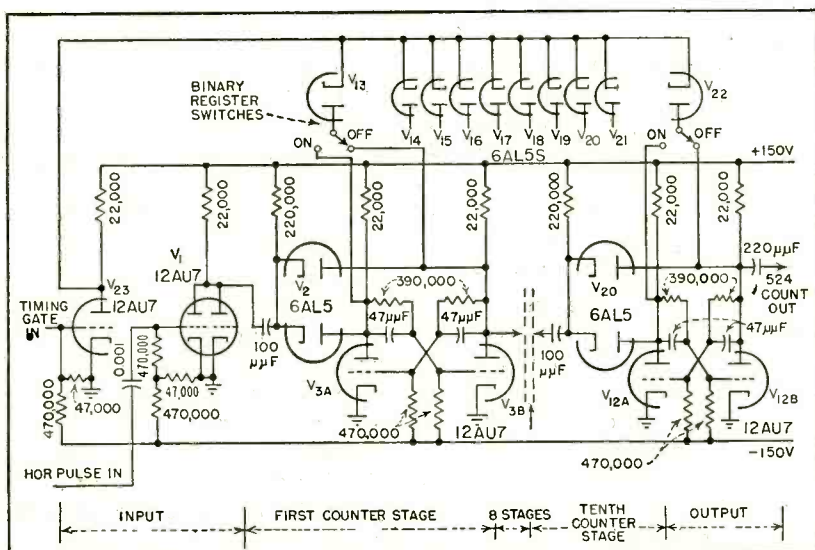

FIG. 6—Output of this counter circuit feeds the stop coincidence circuit

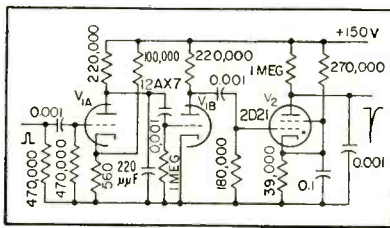

FIG. 7—Pulse amplifier, which is fed a 0.01-volt positive pulse from the cathode of the phototube. A 140-volt negative pulse is produced at the plate of the 2D21 to feed the start coincidence circuit

of general application wherever gray-scale correction is required.

The gray scale of the reproduced picture depends on the overall transfer characteristic of the system elements intervening between the scene and the picture. The transfer characteristic can often be expressed in terms of the exponent of a power-law relation, the exponent being analogous to the familiar gamma of the photographic art.

A gamma greater than unity indicates compression of the blacks and expansion of the whites; lower than unity indicates the converse effect. A very high exponent is associated with a harsh or contrasty picture; a very low exponent is associated with a flat or washed-out picture. A gamma of about 1.5 at the screen is considered to be most pleasing for motion-picture exhibition by direct projection.

Current television practice results in an exponent greater than unity, principally because of the individual transfer characteristics of the light-to-signal and signal-to-light transducers. Direct studio pickup involves only a single pair of transducers, namely, the pickup tube in the camera and the cathode-ray tube in the receiver. The resulting transfer characteristic is quite acceptable. The video recording process introduces two additional transducers, as well as the film on which the recording is made, and the cumulative effect may be far from acceptable.

Assume that a linear transfer characteristic (exponent of 1 in the reproduced picture) is the desired objective, and that the overall system response is such as to result in an exponent of 2. An amplifier is in-

serted in the video line and is adjusted to provide a transfer characteristic which follows a 0.5-power-law relation between its own input and output. Prior to correction, the brightness of the reproduced picture follows the square of the scene brightness. The video signal is modified by insertion of the amplifier, the amplifier output signal following the square root of the input signal. With this correction, the brightness of the reproduced picture is linearly related to the scene brightness.

The heart of the amplifier is a germanium crystal diode. The resistance of the diode varies with the crystal current. One portion of the resistance-versus-current characteristic can be closely approximated by the relation, $R = KI^{-0.5}$, where K is a proportionality constant and R and I are crystal resistance and current, respectively. The amplifier circuit which utilizes this characteristic is shown in Fig. 8.

The first 12AT7 operates as a cathode follower and delivers a voltage replica of the video waveform at point A. Video black level is at ground potential; video white level is at approximately 0.3 volt positive. The cathode load on this first tube is an essentially constant resistance. The crystal resistance, even at maximum value, is negligibly low in relation to the resistor in series with it. The cathode follower can therefore be regarded as a low-impedance source feeding a constant-resistance load. The load consists of two voltage dividers having significantly different characteristics.

The voltage divider composed of R and the germanium crystal diode delivers its voltage output at point B. Because of the relatively high constant resistance of the resistor, and the negligibly low resistance of the crystal diode, the current through the crystal diode is a replica of the video waveform. The voltage across the diode is, however, influenced by the crystal resistance characteristic. The voltage at point B is thus a power function (exponent = 0.5) of the voltage at point A.

The voltage divider composed of R_1 and R_2 delivers its voltage output at point C. The voltage at this

point is a linear function (or a power law of unity exponent) of the voltage at point A. The potentiometer arm is set for equal white level voltages at points B and C.

Both voltage outputs are applied to the second 12AT7. Each half of this second tube functions as a cathode follower. Video output voltage can be obtained from point D, E, or from any intermediate point F. Point D provides maximum correction, point E provides minimum correction, and point F provides any intermediate value of correction.

Sound

The sound portion of the equipment is planned for direct positive variable density sound-on-film recording, using a recording system developed by J. A. Maurer, Inc.

The positive film stocks used in video recording are relatively insensitive in comparison to the negative film stocks which are normally

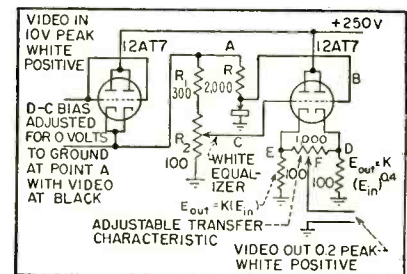

FIG. 8—Circuit of power-law amplifier for correcting gamma

used in motion picture photography. Considerably more light is required if the optimum density range of the film is to be utilized. The sound recording system uses larger than normal optical apertures to allow an approximately fourfold increase in illumination level.

A precisely-shaped mask compensates for the nonlinearity of the light-transmission-versus-exposure characteristic of the film.

BIBLIOGRAPHY

- F. N. Gillette, The Picture Splice as a Problem of Video Recording, *Jour. SMPE*, 53, p 242, Sept. 1949.
- C. R. Keith, Sound-on-Film Recording for Television Broadcasting, *Jour. SMPE*, 53, p 242, Aug. 1949.
- Films in Television, *Jour. SMPE*, 52, p 363, April 1949.
- T. T. Goldsmith, Jr., H. Millholland, Television Transcriptions, *ELECTRONICS*, p 68, Oct. 1948.

PRODUCTION TESTER

Transistor characteristics are determined quickly and accurately by a-c test apparatus. Circuit design information is furnished as well as operational test results. Includes provision for electrically forming transistors

VOLTAGE GAIN, current gain and input impedance of transistors for various emitter biases and collector load resistances are determined quickly and conveniently by the transistor testing apparatus shown in the photograph. Since no general set of curves can describe

each transistor, this tester furnishes specific design information as well as operational test data.

The equipment has a built-in circuit to modify the electrical characteristics of a transistor and an oscilloscope for visual inspection of its diode characteristics.

Figure 1 is a block diagram of the circuit. The transistor is connected in the conventional manner with 500 ohms in the emitter circuit and a 400 to 42,000-ohm variable resistor in the collector circuit. The emitter bias is supplied by a center-tapped voltage divider so that either positive or negative d-c voltage may be applied. The collector is supplied 60-cycle a-c voltage through the isolation transformer *T*. A crystal-diode rectifier *D*, in series with the collector probe, is connected in opposition to the direction of rectification of the collector probe itself. When not shorted out by *S*₂, it will have the positive half-cycle voltage of the 60-cycle supply developed across it, permitting the collector probe to be swept in negative polarity only. With *S*₂ closed, the magnitude of the forward current in the collector may be varied by the variable resistor in series with *S*₂. The negative peak value of the 60-cycle collector current is read on *M*₂ as the 20- μ f capacitor shown in Fig. 3 charges through diode *D'*. Switch *S*₁₂ selects the proper series resistance to read either 10 or 20 ma full

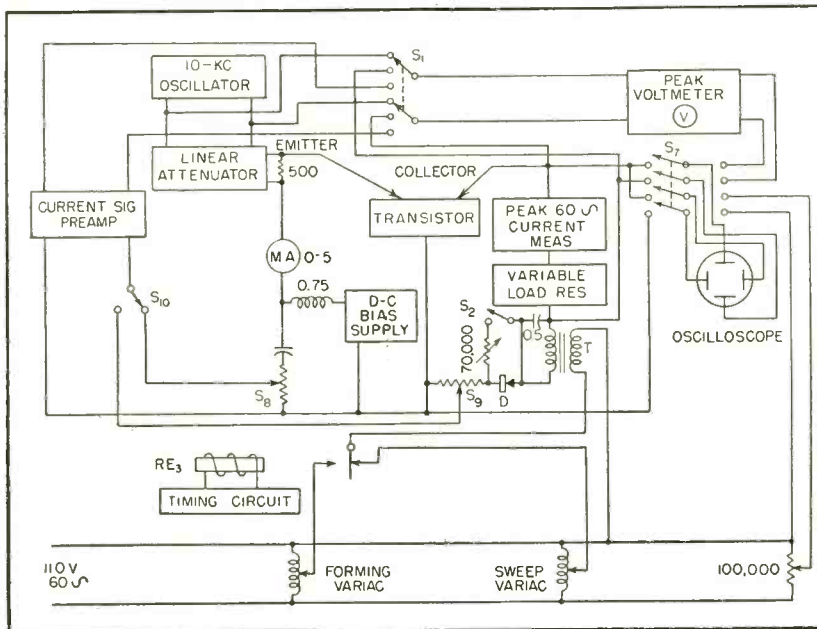

FIG. 1—Block diagram of a-c test apparatus

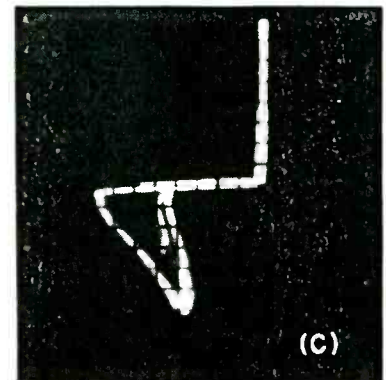
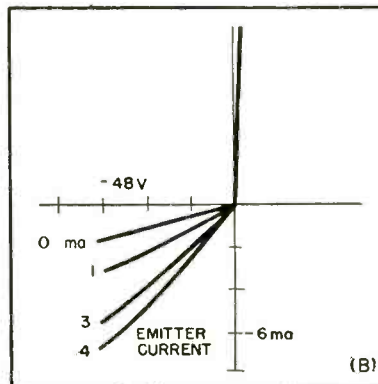
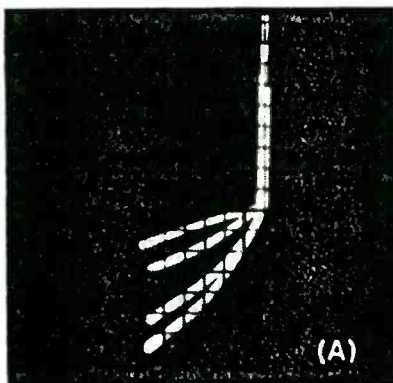

FIG. 2—Scope trace (A) shows collector volt-ampere characteristic of transistor while line diagram (B) gives typical bias conditions of emitter current and collector voltage. Back-voltage breakdown of crystal due to forming pulse is shown at (C) as seen on scope

for TRANSISTORS

By L. P. HUNTER
and R. E. BROWN

Research Laboratories
Westinghouse Electric Corp.
Pittsburgh, Pa.

scale. The peak collector voltage may be read directly from the trace on the calibrated oscilloscope screen.

Voltage Gain

Voltage gain of the transistor is measured at 10 kc by applying the output of the 10-kc oscillator to the emitter through the linear attenuator and comparing the 10-kc voltage developed across the load resistor with the direct output of the oscillator. Voltage comparison is made by means of the peak voltmeter and S_1 , as shown in Fig. 1. If the linear attenuator is adjusted so that the two voltages are equal, the voltage drop in the linear attenuator is balanced by the gain of the transistor, and the reading of the attenuator equals the voltage gain of the transistor. The 60-cycle sweep voltage is filtered from the input to the peak voltmeter so error will not be introduced.

A similar method is employed to measure current gain. The relationship of collector and emitter currents is determined by comparing voltage drops across resistances selected by step switches S_2 and S_3 . These signals cannot be fed directly into the peak voltmeter but first must be amplified as shown in Fig. 4A. Step potentiometer S_4 (Fig. 1) is adjusted to pick up the same value of 10-kc voltage as appears across the resistance selected by S_3 . The current gain can be read directly from the setting of the step potentiometer. The decimal point is determined by S_5 .

The input impedance may be found by measuring the voltage and current gains at a known value of load resistance, since the voltage gain is equal to the current gain multiplied by the ratio of load resistance to input impedance.

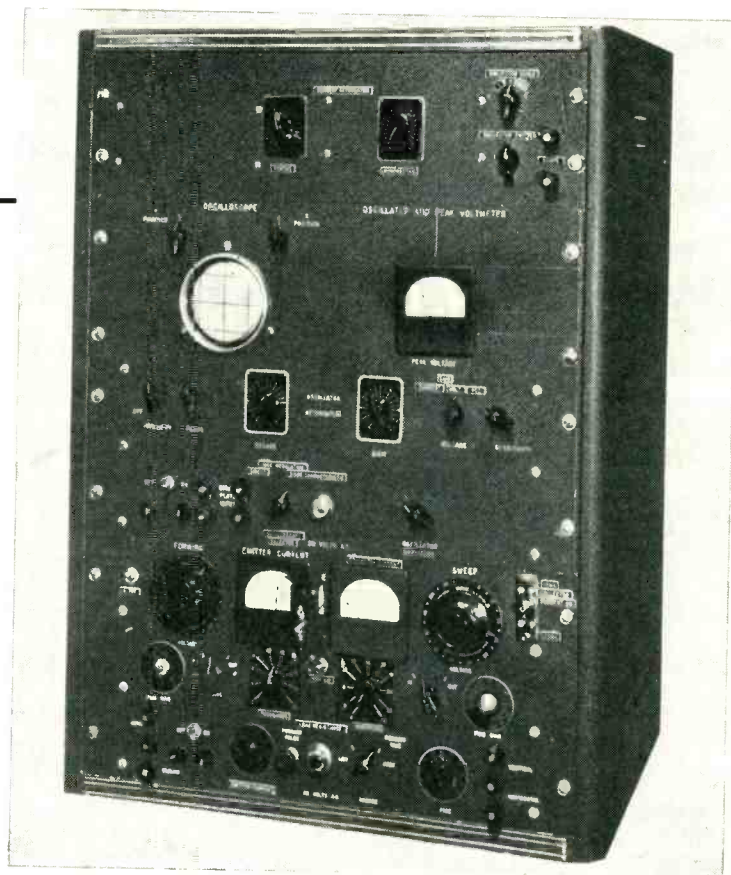

Production tester for transistors

The collector volt-ampere characteristic is shown on the oscilloscope with the voltage across the collector on the horizontal plates and the voltage across the load resistor on the vertical plates. The 10-kc voltage amplitude is negligible compared to the 60-cycle sweep voltage so the trace is not broadened appreciably if voltage gain measurement is made while the collector characteristic is being examined. Figure 2A shows a typical characteristic. Figure 2B gives typical bias values of collector current and voltage.

Short-circuit current gain α may be measured by adjusting the load resistance to equal the a-c resistance of the collector-characteristic line at the desired operating point, measuring the current gain and doubling it. The collector characteristic on the oscilloscope may be used to adjust the load resistance to this value. The load re-

sistance is varied until the voltage drop across the load is equal to the voltage drop across the transistor. To facilitate this adjustment, a diagonal line is ruled on the oscilloscope screen at the proper angle and the collector characteristic trace is made parallel to this line by varying the load resistance.

Forming Circuit

To form the collector probe of the transistor a second 60-cycle sweep voltage of large magnitude is applied momentarily to the transformer in the collector circuit. The duration of this forming pulse is determined by the timing circuit through RE_3 . The ratio of forward to backward current in the collector is controlled during the forming pulse in the same manner as for the sweep. A range of forming pulse lengths from 20 cycles to one cycle is available. The forming pulse is applied by pressing the

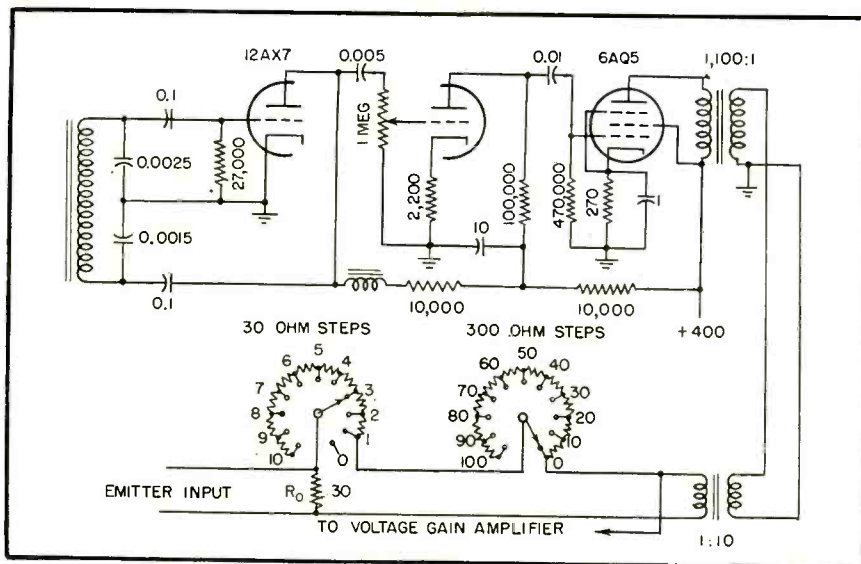

FIG. 5—Ten-kc oscillator furnishes test signal while linear attenuator gives direct gain reading

voltmeter alone will register balance.

The 10-kc attenuator in Fig. 5 consists of two 10-step potentiometers in series. The first adds 300 ohms resistance in each step. The second adds 30 ohms per step.

The output of the attenuator is always taken across the 30-ohm resistor, R_0 . When the attenuator is on position 1, the 30 ohms is in parallel with the secondary of the transformer and may load the oscillator amplifier to some degree depending on the secondary impedance. This does not create an error in the measurements since all tests are of a comparison nature. Above position 3 this effect disappears. Increasing the attenuator from position 1 to position 2 drops the voltage across the output resistor by one-half. The next step drops the voltage by one-third. These fractions represent the ratio of the attenuator-output voltage to input voltage, therefore the step-position numbers indicate directly the voltage factor by which the 10-kc oscillator output is attenuated. When this attenuation is balanced by the gain of the transistor, the numbers read directly the voltage gain of the transistor.

Current Gain Measurement

The method of measuring current gain makes use of extremely small signals compared to those used in voltage-gain measurement. These

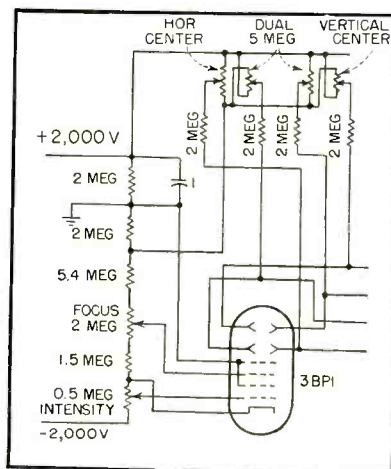

FIG. 6—Oscilloscope displays both gain measurement and transistor characteristics

signals are amplified by the circuit shown in Fig. 4A. Since the amplitude of the 60-cycle current in the collector circuit is large, and only the 10-kc current is to be measured, a 60-cycle filter is added ahead of the preamplifier to prevent saturation by 60 cycles. A twin-T filter¹ was chosen because it is possible to tune such a circuit to cancel out one frequency completely. The twin-T circuit's relatively low input impedance is no disadvantage since the original signal appears across a resistance of the order of 10 ohms. Following the preamplifier, there are terminals for an external oscilloscope, which are used if current and volt-

age gains are read simultaneously.

The signal used to measure current gain is so small that any stray signals caused by inter-winding capacitance in the oscillator output transformer will add a constant factor to the readings. This effect is minimized with the addition of the second transformer by permitting grounding of the secondary of the first output transformer.

Oscilloscope

Through switches S_1 , S_7 and S_{10} , the scope shown in Fig. 6 becomes multipurpose. The circuit consists of a 2,000-volt power supply, a potential-dividing system, centering controls for the scope traces and a system of calibrating the horizontal and vertical scope traces in volts as illustrated in Fig. 6. Horizontal and vertical deflections are varied simultaneously by varying the second-anode voltage, thus maintaining a vertical-to-horizontal deflection ratio of 7 to 10. The voltage is usually set so the horizontal sweep is 7 volts per division. The vertical calibration is 10 volts per division.

Oscillator

The Colpitts oscillator shown in Fig. 5 is tuned to 10 kc. The signal is amplified and fed to the linear attenuator and the peak voltmeter. The oscillator has proved stable in both amplitude and frequency. Binding posts on the front panel are provided for an external oscillator should measurements at another frequency be required.

This apparatus has been used in production of transistors to check the semiconductor ingots before cutting, to select the best pieces after cutting, to check the best probe adjustment, to form electrically the finished transistor, and to grade the final product. It has also been used to pick the best transistor for a given circuit application, and to give the information necessary for a proper choice of other circuit components. It has been used to check periodically the characteristics of transistors when in use, and to carry out experiments on transistors in statistical quantities.

REFERENCE

- (1) A. Wolf, A Note on Parallel T Resistance Capacitance Networks, *Proc. of IRE*, 34, Sept. 1946.

Selective Mixing Amplifier For Aircraft

Unit combines ten channels of communication and navigation audio information in any combination, selected separately by pilot and copilot, without mutual interference between used and unused channels. Fail-safe arrangement insures reliable operation

WARTIME and postwar developments in the field of communications and navigation are in daily use along the airways. The opening of vhf channels for range, traffic control and ILS has increased the complexity of aircraft radio installations. Connecting headphones to one or two receivers is not difficult, but handling the various audio channels of a modern installation of several receivers and transmitters is definitely an engineering problem.

The duties of pilot and copilot are such that it would in fact be desirable for each to have entirely independent radio systems. Such an installation would be most uneconomical of space and weight. It is possible, however, to attain a high degree of efficiency from a minimum amount of equipment by running all audio signals through a multichannel dual-output isolation amplifier.

The amplifier to be described provides a means of integrating almost any composite installation into a highly efficient and practical system. Because all audio signals pass through this amplifier it has necessarily been made fail-safe. That is, in the event of partial or complete failure, it is easily disconnected from the circuit by the pilot or copilot in such a way that service is uninterrupted. Isolation of the two circuits is such that there is no crosstalk. Sufficient output power is available to drive small cabin speakers, thus eliminating the fatigue of wearing headphones. Since the amplifier is optional equipment, it has been designed to

By **PAUL B. KING, Jr.**

*Aircraft Radio Corporation
Boonton, New Jersey*

be added to existing installations.

The F-11 isolation amplifier is capable of handling ten audio input circuits. Two of these circuits are

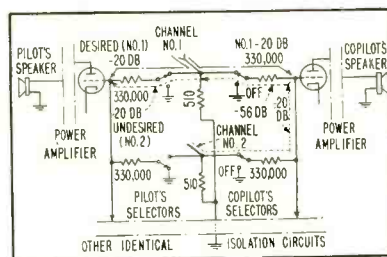

FIG. 1—Two of the ten basic isolation circuits are shown. The pilot is connected only to channel 1, while the copilot hears channel 1 and channel 2 simultaneously

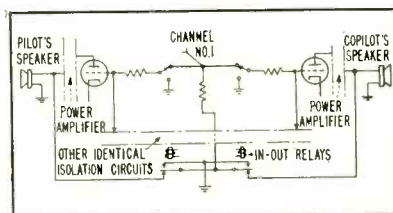

FIG. 2—Fail-safe relays (normally energized when equipment is in use) drop out and bypass amplifier in the event of component failure

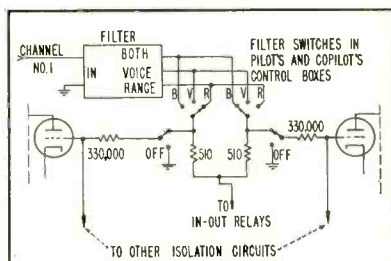

FIG. 3—With a single range filter, pilot and copilot can independently choose range, voice or both

divided in such a way that the outputs of two receivers can be terminated in two range-voice filters. Pilot and copilot can then independently select any combination of range, voice or both filter outputs without mutual interference. A typical assignment of audio circuits to the various channels is as follows:

Channel Number	Audio Circuit
1	ADF receiver Range-Voice-Both
2	L-F range receiver Range-Voice-Both
3	ADF receiver
4	Broadcast receiver
5	VHF navigation receiver
6	VHF communication receiver
7	Marker beacon receiver
8	H-F transmitter sidetone
9	VHF transmitter sidetone
10	Intercom

The photographs show the complete unit and the under side of the chassis, base removed. Connections are made by means of multi-wire ceramic-insulated connectors plugged into receptacles mounted on the front plate.

Basic Circuit

The basic isolation circuit is shown in Fig. 1. For simplicity only two of the ten circuits are drawn in detail. Each input channel provides a 500-ohm load for the circuit connected to it. As shown, the pilot is connected to channel 1, while the copilot is connected to channels 1 and 2. In the case of the pilot, the desired signal from channel 1



Packaged design permits addition of selective isolation amplifier to existing aircraft systems

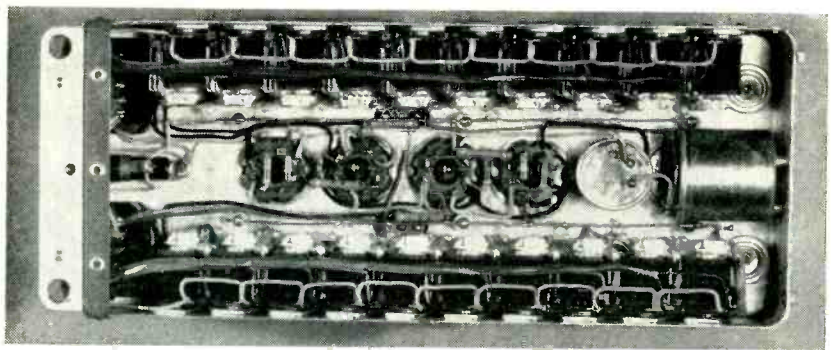

All channel switching is accomplished from the cockpit by means of d-c relays which are located underneath the amplifier chassis. Low-impedance audio lines between amplifier and cockpit are free from crosstalk

passes through the closed switch, a 300,000-ohm isolating resistor and thence to the grid of his isolation-amplifier tube. Because the nine other isolating resistors connected to this grid are grounded, the desired signal suffers a reduction of only 20 db.

The signal from channel 2, to which the copilot is also listening, reaches the grid of the pilot's amplifier by the path indicated. It can be seen that it undergoes the following losses: (1) to copilot's amplifier grid -20 db, (2) to circuit 1 input load -56 db, and (3) to pilot's amplifier grid -20 db. The undesired signal level is therefore 96 db below the input level or 76 db below the level of the desired signal at the grid of the pilot's amplifier. Actually common ground currents and cross coupling reduce this to about 60 db.

All audio switching is done by relays. The selector relays are located in the bottom portion of the chassis along the sides. The arrangement can be seen in the bottom-view photograph. Relays permit short unshielded leads between receivers and amplifier. All wiring between amplifier and cockpit is d-c and high-level low-impedance audio. These wires are not subject to cross coupling or noise pick-up.

Operation

Figure 2 shows a modification of the basic circuit to provide a means of bypassing the amplifier in the event of component failure. The two relays are connected in the common lead of the input load resistors. When energized this lead is grounded and operation is as de-

scribed above. The relay coils are connected directly to the primary power circuit. When this circuit is broken by fuse failure or manual switching, the relays open and connect the common lead of the input load resistors directly to the output circuit. The loss introduced in each receiver line by the load resistors and shunting effect of other receivers is about 10 db. This loss, although noticeable, is not sufficient to impair operation of the system and the receivers can be shared by pilot and copilot as before installation of the amplifier.

Figure 3 shows a method of using a range-voice filter in one channel. The filter is the receiver load. The input load resistors are now divided and brought to separate pins of the input receptacle. These pins are connected to the arms of pilot and copilot filter switches. The pilot and copilot can now connect their input circuits to filter output range, voice or both. No crosstalk will result if both users are connected to the same circuit but there will be a noticeable reduction in output (3 db). If this cannot be tolerated,

the use of separate filters is recommended.

It is desirable to cut off or mute all incoming signals during transmission. Isolated muting circuits are desirable because the speaker only requires perfect quiet. The use of selector relays makes possible receiver muting as desired. Figure 4 shows the muting circuit.

The selector relay circuits are energized by completing their coil circuits to ground by means of individual selector switches. Any circuit or group of circuits may be muted by breaking the common ground lead of the corresponding selector switches. This is easily done by the muting relay which is operated by the microphone key circuit when the button is pressed to talk. Muting relays are usually located in the control boxes.

Installation

A complete installation permits independent selection of 1 to 10 audio channels by pilot and copilot, independent choice of range-voice filters on two circuits and independent muting of receivers, also choice of speaker or headphone operation. The design of the amplifier unit is such that an input signal of 300 mw will produce 3 watts output for loudspeaker operation.

At this time it is felt that the 10-channel amplifier is adequate for most needs. Another such unit can be added as the number of channels increases. Thus pilot, copilot, radio operator and flight engineer can listen to any combination of the 10 facilities without mutual interference.

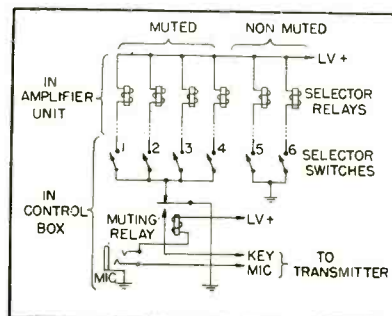

FIG. 4—Special circuit mutes incoming signals during transmission periods

Precision Phasemeter

PHASE DIFFERENCE measurements accurate to 0.1 degree are obtained by the precision phase meter shown in the photograph.

Phase comparison is accomplished by a detector bridge consisting of four 5647 diodes arranged as a ring modulator. Phase difference is read directly from a decade voltage divider which controls the amount of quadrature voltage added to a reference signal.

The instrument is self-calibrating and provides sense information to remove 180-degree ambiguity. Figure 1 shows a block diagram of the phasemeter.

Some proposed applications of the instrument are in testing poly-phase systems, goniometers, wide-band phase-shifting networks for single-sideband transmitters and feedback amplifiers. It may also be used in filter, transformer and network design and in measurement of residual L and C in resistor units.

Basic Method

The method developed by J. R. Ragazzini and L. A. Zadeh¹ forms the basis for design of the precision phase meter. It can be classified as a phase comparison method. The phase meter is seen in the simplified block diagram of Fig. 2 to consist of two signal channels terminating in a phase detector, which need only indicate approximate phase quadrature between its input signals. Two phase shifters, one

Specifications

Frequency Range	—30 to 20,000 cps
Phase Range	—0–360 degrees
Accuracy	—0.1 degree absolute (0.01 degree for incremental angles up to two degrees)
Signal Level	—0.5 to 10 volts rms
Input Impedance	—10 megohms shunted by 25 μf
Display	—decade null system
Power Supply	—105–125 volts rms, 50/60 cps
Size	—19½" wide \times 16¼" deep \times 25" high
Weight	—110 pounds including walnut cabinet



Precision phasemeter gives phase difference of two sinusoidal voltages directly in degrees

calibrated and the other uncalibrated, are inserted in series with one or the other channel. Either phase shifter can modify the phase difference between signals at the phase-detector input as compared with those at the phase meter input.

The phase meter is calibrated by applying a single test signal to both input terminals, and setting the calibrated phase shifter to zero. The uncalibrated phase shifter is adjusted so that the phase detector indicates a condition of balance.

To measure phase difference, the input terminals of the two channels are separated and connected to the two signals whose phase difference is sought. The phase detector will then show a condition of unbalance. The indication of balance is restored by adjustment of the calibrated phase shifter.

The operation of the calibrated phase shifter is shown in Fig. 3A, B, and C. In Fig. 3B the input signal $E_1 \angle 0^\circ$ is shown. Added to this signal in exact quadrature is a vector $E_1 \tan \theta$. The resultant E_R is phase-displaced by an angle θ from the original vector. In Fig. 3A is shown the method of producing vector $E_1 \tan \theta$. The amplifier of gain A has capacitive reactance X bridged from input to output. It can be shown that for $R = X$, the

By **J. KRITZ**

Senior Engineer
W. L. Maxon Corp.
New York, N. Y.

overall gain is unity and the phase shift is closely equal to 90 degrees. The error in quadrature is approximately $1/A$ radians. For values of R unequal to X due to frequency variations, the accuracy of the quadrature relationship is essentially maintained with the output amplitude varying directly with frequency. The output divider can then be calibrated in terms of $\tan \theta$.

For the condition $R = X$, all values of calibrated phase shift up to 45 degrees may be obtained by properly adding the two voltages. An additional 45 degrees can be obtained by merely switching the divider to the $E_1 \angle 0^\circ$ vector before summation. The vector diagram of this relationship is shown in Fig. 3C. It can be seen that phase angle calibration is independent of frequency provided the $R = X$ condition is maintained throughout the band. Similar results are obtained if R and X are interchanged. The circuit shown is the preferred arrangement since it displays an integrating characteristic to harmonics. It does however tend to accentuate low-frequency noise which is controlled by R-C cutoff filters in the band switching.

The condition of $R = X$ or unity gain requires adjustment of R for each frequency of measurement. The balance voltmeter used for this purpose is shown in Fig. 4A. The input and output signals of the 90-degree amplifier are fed to a pair of stable feedback amplifiers which in turn feed a pair of full-wave averaging rectifiers. The d-c output of these rectifiers is applied to a microammeter through a pair of self-protecting cathode followers. The two inputs are connected to the same signal source to establish amplitude equality. The gain of one amplifier is adjusted to obtain a

for Audio Frequencies

One-tenth degree accuracy is obtained in phase-difference measurements between two sinusoidal voltages. Problems in design of a commercial instrument to this accuracy are discussed. Self-calibration procedure is outlined

balance reading on the zero-center microammeter. The inputs are then connected to the 90-degree amplifier with the meter serving as indicator for the balance condition. The required sensitivity of one part in 3,000 is obtained with amplifier gains of approximately 250. A schematic diagram of the balance voltmeter circuit is shown in Fig. 5.

Method of Display

The mechanical calibration of a continuously variable potentiometer is not feasible for a dynamic range of 360 degrees with 0.1-degree accuracy and a sensitivity of discernment of 0.01 degree. A combination of 23 precision fixed resistors is used to obtain 2-degree intervals. These intervals are chosen by means of two switches, the first selecting any 10-degree value from 0 to 80 degrees, the second selecting any of five additional two-degree intervals. The transition around the 45-degree point is accomplished automatically as the tens or units dial is rotated. The interpolation of the remaining 2-degree interval is provided by the phase comparator.

The phase comparator must have a sensitivity sufficient to resolve phase deviations of the order of 0.01 degree. It must be capable of measuring such incremental angles accurately over a range of two degrees. The comparator is shown in block form in Fig. 4B. It is an application of the classical wattmeter circuit or ring modulator. The d-c output current measured by the zero center microammeter balances when a 90-degree phase difference exists between the two channel voltages. The d-c current is a function of the signal ampli-

tudes and the cosine of the phase-difference angle.

For plus or minus one-degree deviation from the balance condition, the d-c current is linear to within 5×10^{-5} degree, so that linear scale calibration is adequate for this interval. A deviation of plus or minus ten degrees departs from linearity by approximately 0.05 degree. This is applied in obtaining coarser phase measurements with greater rapidity by shunting the meter to obtain a plus or minus ten-degree scale.

Amplitude inaccuracy is virtually eliminated by setting the levels on the phase-detector bridge to prescribed values. Misadjustment of more than ten percent of both levels is required before impairing the 0.1-degree accuracy with the meter at full scale.

Analysis of the ring modulator disclosed that at discrete operating level ratios various orders of odd harmonics in one channel would be rendered ineffective in producing errors. Since the bridge is insensitive to even-order harmonics, levels were designed for cancelling third-harmonic effect in channel 2. The 90-degree amplifier is integrating in character and is therefore used

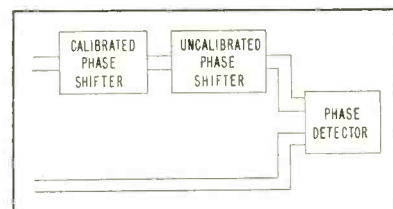

FIG. 2—Simplified block diagram illustrates phase-comparison method of measurement

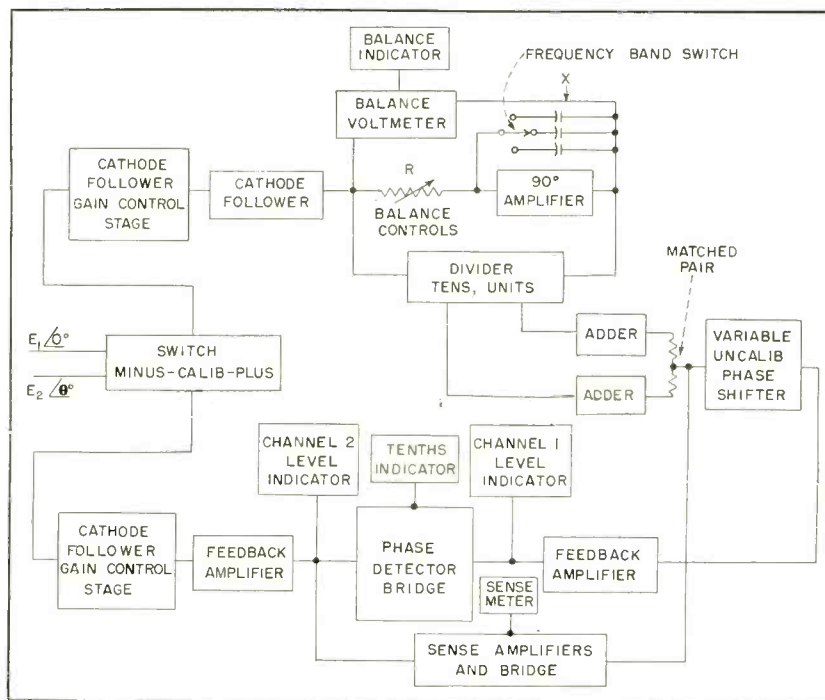

FIG. 1—Block diagram shows path of input signals to phase-detector bridge. Divider gives phase-difference reading

for feeding channel 1. The result is to preserve meter accuracy in the presence of harmonics.

Sensing Circuit

The 90-degree amplifier and dividers are capable only of calibrated phase shift over 90 degrees. An additional 90-degree shift is obtained by interchanging the positions of the uncalibrated phase shifter and the uncalibrated phase shifter shown in Fig. 1. The phase comparator is however, ambiguous about 180-degree points. A sensing circuit consisting of a low-level wattmeter 90 degrees out of phase is used to indicate the quadrant. While a value between zero and 90 degrees is read on the phase meter, a switch position indicates polarity and the sense meter indicates whether or not 180 degrees must be added.

Developmental Problems

For 0.1-degree accuracy, it is necessary to limit individual known error effects to a maximum of 0.01 degree. The gain of the 90-degree amplifier contributes an error effect approximately equal to $1/A$ radians. Therefore high orders of gain must be achieved in the presence of a 0.7-feedback ratio at 45 degrees at operating frequency. The schematic of the 90-degree amplifier is shown in Fig. 6.

Stray capacitance across R (Fig. 3A) contributes error in the form R/X_{STRAY} radians while leakage re-

sistance across X contributes X/R_{leakage} radians. This complicates amplifier design in that a low operating-impedance level is required to minimize these errors. An amplifier with a cathode-follower output working at an impedance level of about 1,000 ohms is employed. The amplifier gain is 4,000 over the frequency band, with amplitude-phase characteristics outside the operating band controlled to insure stability. High quality polyethylene capacitors with Q 's of the order of 5,000 are used.

Resistor R must be capable of stable adjustment to one part in 3,000 to achieve a settability of 0.01 degree at 45 degrees. Three series controls are used to adjust R : a coarse-control 31-position attenuator, a medium-control 31-position attenuator and a smooth low-resistance rheostat for fine control. The coarse control is calibrated in frequency to permit easy, rapid adjustment with the balance voltmeter.

Adding two signals with phase accuracy better than 0.01 degree and amplitude accuracy of one part in 3,000 is accomplished by two feed-back amplifiers with low-impedance (less than one ohm) cathode-follower outputs that feed a pair of precision-balanced 5,000-ohm resistors whose centertap is fed to the high-impedance input of the subsequent amplifier stages. Thus the effects of vacuum-tube variations and of component aging are virtually eliminated. Figure 7 shows the circuit of one of the amplifiers.

Vacuum diodes are used in the phase-detector bridge because of the linearity and consistency of diode characteristics even with heavy loading. Since contact potential and diode characteristics are critically dependent upon heater potential and vibration, stability is achieved through use of subminiature ruggedized diodes (type 5647) suspended in a sealed potted container. The heater supply is current regulated.

The output transformers feeding the diodes are designed for maximum primary inductance and minimum variation with level adjustment. Leakage reactances between

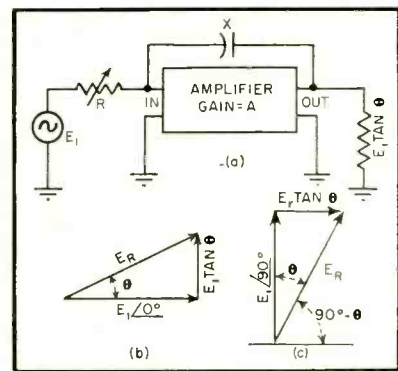

FIG. 3—Calibrated phase shift is obtained by adding quadrature voltage to input signal

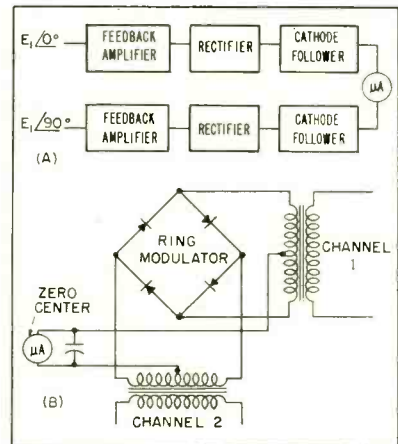
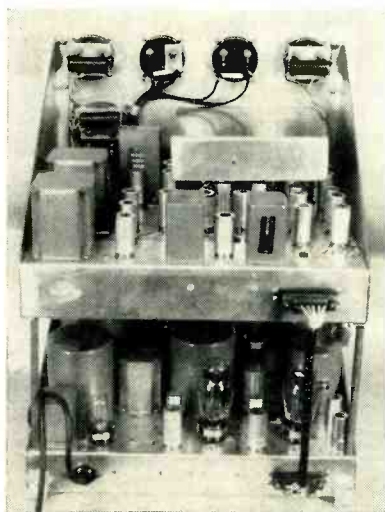

FIG. 4—Balance voltmeter (A) indicates signal amplitude equality. Phase-detector bridge (B) responds to signals in quadrature

half secondaries and primary are maintained small throughout the range.

The output stage is a push-pull Class-A amplifier with 30-db feedback, driven by direct-coupled cathode followers to eliminate phase-shift variations at low frequencies due to small grid conduction. The output-level meters are specially designed rectifier types flat to within $\frac{1}{2}$ db from 30 to 20,000 cps.

Due to the low operating impedance levels used throughout the design, common coupling at high frequencies presents little difficulty. Elimination of coupling at low frequencies through the common impedance of the power supply requires three separate anode sources. Their self impedances are kept below one ohm and their transfer impedances below 0.01 ohm with a combination of L-C filtering and electronic regulation. A schematic of the channel-1 output amplifier



Rear view of instrument removed from its cabinet. Three anode-voltage supplies are provided

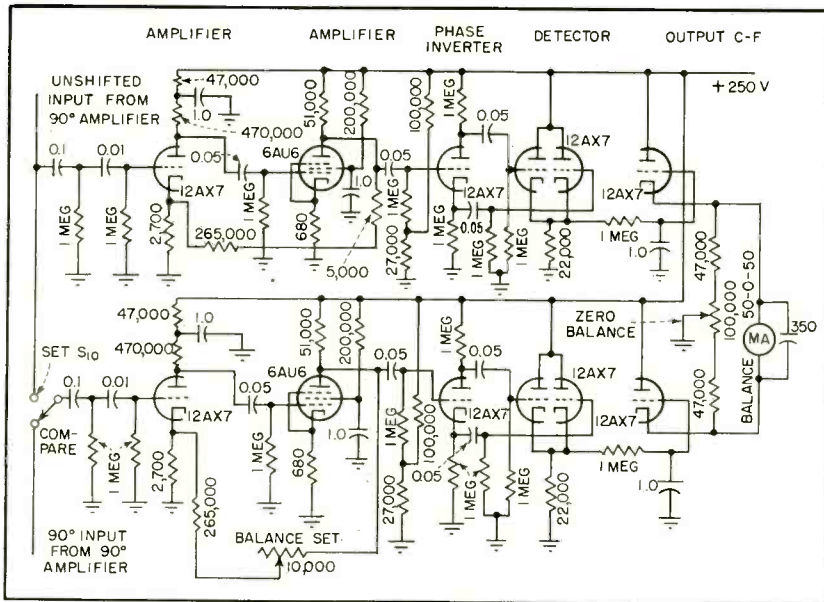

FIG. 5—Circuit of balance voltmeter used to display departure in voltage equality of one part in 3,000

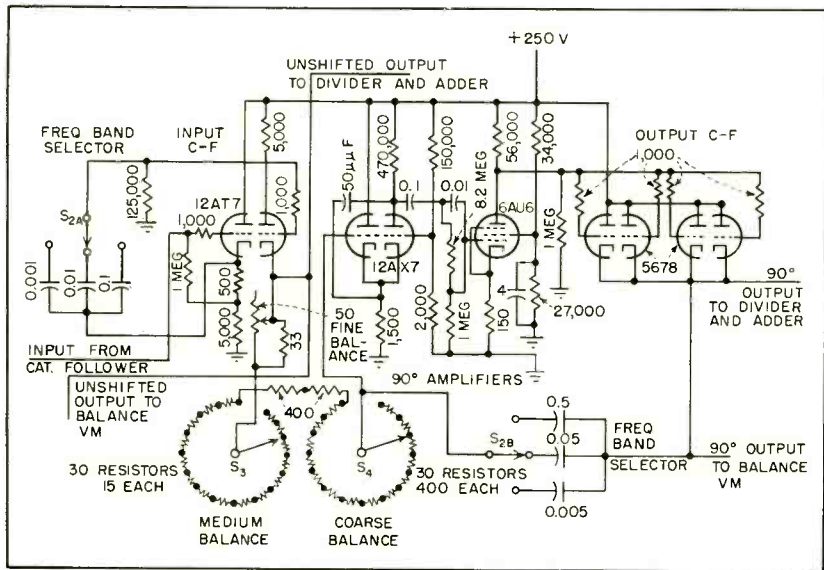

FIG. 6—Circuit of 90-degree amplifier with high-pass filter and low-impedance cathode-follower output

and uncalibrated phase shifter is shown in Fig. 8.

Test Methods

To determine performance characteristics within the specified tolerance, a test method capable of divulging 0.01-degree error is necessary. Such orders of accuracy are unobtainable in any primary standard. The use of accurately calibrated phase shifts created by resistive-reactive networks and carefully measured frequencies is unsuitable. In the most favorable case of a single 45-degree R-C network, calibration accuracies suitable at one frequency only are of

the order of 1.75 parts per 10,000. This assumes basic calibration equipment of such complexity as is available only at the Bureau of Standards. The method employed uses the instrument itself to divulge its own error.

A phase standard of zero degrees implies connection to the same signal source. In addition, two variable uncalibrated phase shifters of the following characteristics are necessary. Input and output impedances must be sufficiently high and low respectively that less than 0.01-degree change is effected by loading one input on another output. The output impedance must

be sufficiently low that less than 0.01-degree change is effected by loading the output with the input impedance of the phase meter.

Design of such phase shifters is readily realizable. Cathode-follower input and output stages of conventional 12AT7-type miniature triodes provide sufficient isolation. The test procedure is as follows:

With the input terminals tied to a common source, the phase meter is adjusted to its calibrating position of zero degrees. It is then connected to measure the shift of one phase shifter which is adjusted to give an exact reading of 180 degrees on the phase meter. The first phase shifter is removed, and the remaining phase shifter is similarly adjusted. The phase meter is then connected to measure the phase shift of the two shifters in tandem. For zero error in the original reading of 180 degrees, the sum should now read 360 or zero degrees. The deviation from zero degrees indicated by the phase meter is double the error at 180 degrees. This permits exact calibration of the true 180-degree point.

This procedure is then repeated with each phase shifter adjusted to 90 degrees as read on the phase meter. The deviation from the previously calibrated 180-degree point when connected in tandem is double the 90-degree error, and the true 90-degree position is evaluated. In this manner 45 degrees, 22½ degrees, etc. may be checked.

By means of the two-degree steps, it can again be shown that eleven equal phase shifts as indi-

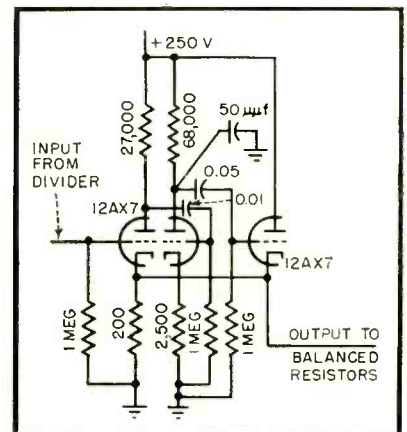

FIG. 7—Low-impedance feedback amplifier used in adder circuits

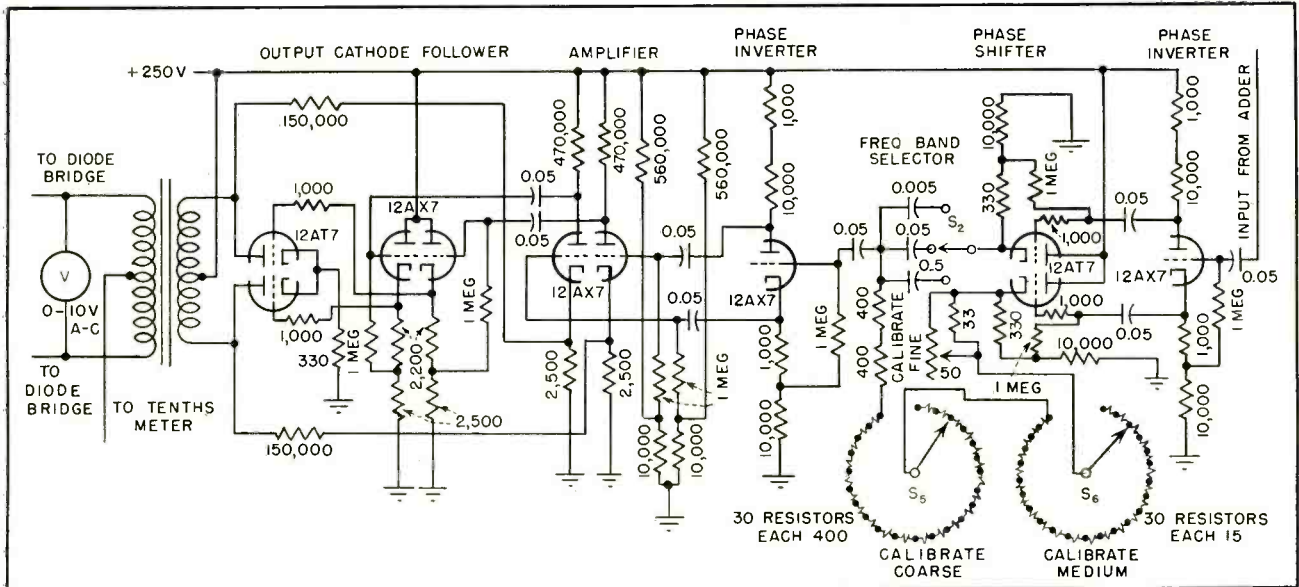

FIG. 8—Channel-one amplifier includes uncalibrated phase shifter and output amplifier. Transformer feeding bridge is designed for maximum primary inductance and low leakage reactance

cated on the degree meter add to 22 degrees, and 22 such equal shifts add to 44 degrees, and 45 such steps add to 90 degrees. In this manner the entire region from -90 degrees to +90 degrees may be tested. The remaining angles of the complete 360 degrees can be checked by a similar process utilizing the 180-degree symmetry of the instrument.

Production Technique

For a large number of frequencies in the spectrum this complete test method is laborious and time consuming. Exhaustive tests on the prototype have borne out theoretical considerations of unobservable error at 180 degrees, and complete symmetry about 180-degree spaced values. Two-degree step tests to 46 degrees in addition to the cardinal points have proved sufficient to guarantee an instrument accuracy of 0.1 degree throughout the range, thus enabling a more rapid production technique. This technique tests the divider accuracy as a basic 45-degree calibrated phase shifter as well as the remaining circuitry which remains unaltered over the entire range.

Evaluation of Tests

The maximum error disclosed in type testing the prototype is 0.06

degree. This represents the maximum accumulation at various angles and frequencies of the calculated 0.01-degree errors in different circuits. Stability of zero calibration is such that measurements to full accuracy are possible after about 15 minutes of warm-up. Variation of vacuum tubes and components within the commercial tolerances shows no effect on performance. Evaluation of performance in terms of harmonic content of the signal source is in process and will soon be available. Preliminary observations indicate no error contributed by even-order harmonics and a tolerance of about

one percent third within stated accuracy. Accuracy and calibration are not disturbed by insertion of filters in the input. Zero calibration may be set even if the filters are not matched.

Equipment Layout

The top row of instruments on the front panel is for indications of balance, channel levels and sense. Immediately below are the major degrees dials and meter. Below these dials, on the left are the three balance controls (R of Fig. 1), with calibrated controls for the uncalibrated phase shifter on the right. The contact potential balance dials and balance voltmeter controls are located in two panel recesses. These elements require infrequent adjustment and are removed from the operating area.

A photograph shows a rear view of the instrument removed from its cabinet. The lower deck is the power supply. Also shown is a top view from the rear with the dust cover removed from the switch box. The ganged degree switches and precision divider resistors can be seen. The first production model has been delivered to the Communication and Navigation Lab., Wright-Patterson Air Force Base, whose cooperation and stimulation aided the program considerably.

REFERENCE

(1) J. R. Ragazzini and L. A. Zadeh, "A Wide Band Audio Phasemeter", National Convention IRE 1949.

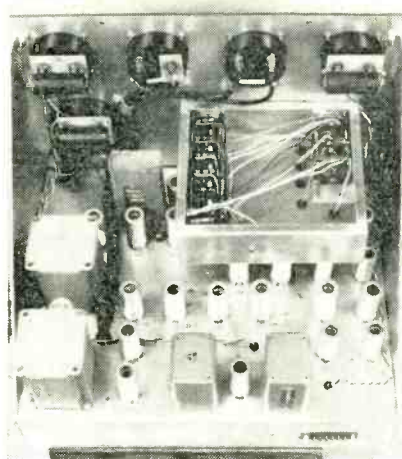

View from above shows ganged degree switches and resistors of precision voltage divider

A Fast Sweep Circuit

Designed for study of extremely short-duration phenomena, the oscilloscope described has a maximum sweep speed of 100 inches per microsecond, obtained from a simple thyatron circuit. Three methods of calibration are employed

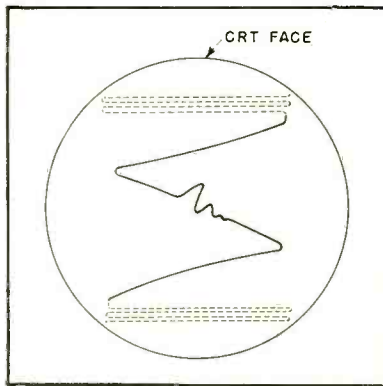

FIG. 1—Stable delayed sweep is provided by modified raster scan

By **N. L. DAVIS**
and **R. E. WHITE**

Naval Research Laboratory
Washington, D. C.

IN ATOMIC STUDIES, the scintillation counter has assumed great importance. With these counters it is now possible to detect the incidence of single alpha or beta particles or single-gamma quanta upon certain types of crystals. When particles strike the crystal, minute fluorescent light flashes are produced.

The use of a multiplier phototube makes it possible to convert these tiny flashes to voltage pulse waveforms, a much more convenient form for recording and studying. The voltage waveforms produced are, however, of extremely short duration and the problem of displaying them in sufficient detail to allow accurate study and counting presents a considerable problem in design of high-speed oscilloscopes. In the field of digital computers there is an increasing requirement for high-speed operation. Such operation demands the use of short-duration pulses. For the observation of such pulse voltages, a fast-sweep oscilloscope is required.

For use in the type of problems mentioned an oscilloscope with the

following characteristics has been developed: The frequency response is uniform to 265 megacycles. It is possible to observe either single traces or recurrent traces to a repetition rate of 5,000 cycles. The unit has a maximum sweep speed of 100 inches per microsecond (0.01 μ sec per inch) with several sweep ranges reaching a maximum sweep length of 25 microseconds. A low-impedance keying pulse is provided for keying external circuits under examination. A variable delay between the external keying pulse and the oscilloscope is available which may be varied from 0 to greater than 3 μ sec.

Requirements

The first three specifications place severe requirements on the cathode-ray tube and its circuitry. The tube must be capable of producing traces of very high brilliance, and the transit time of the electron beam through the deflection plates must be sufficiently low to permit the required frequency response. The performance of the cathode-ray tube on both of these factors is improved by the use of very high accelerating potentials.

Two DuMont crt types are designed for high-speed oscilloscope

applications. A few of the pertinent characteristics of these two tube types are compared in the accompanying box. For the oscilloscope to be described, the 5RP-A satisfies the required brilliance and frequency limits and was used because of its immediate availability.

Sweep Circuitry

With an accelerating potential of 20,000 volts on the 5RP-A tube, a deflection sensitivity of approximately 0.005 inch per volt may be expected. For five inches deflection approximately 1,000 volts of sweep voltage is required. If the fastest sweep (100 inches per μ sec) is considered, a voltage slope of 20,000 volts per μ sec must be developed for a sweep wave form.

Two general methods of generating suitable sweep voltages were investigated: modified raster scan using vacuum tubes, and sweeps generated by hydrogen thyatrons.

The modified raster scan produces the presentation shown in Fig. 1. To develop this scan, a two-megacycle oscillator is keyed to provide either sine-wave sweeps or a series of linear sawtooth sweeps. The cathode-ray tube is then unblanked during the interval under investigation. Coinciding

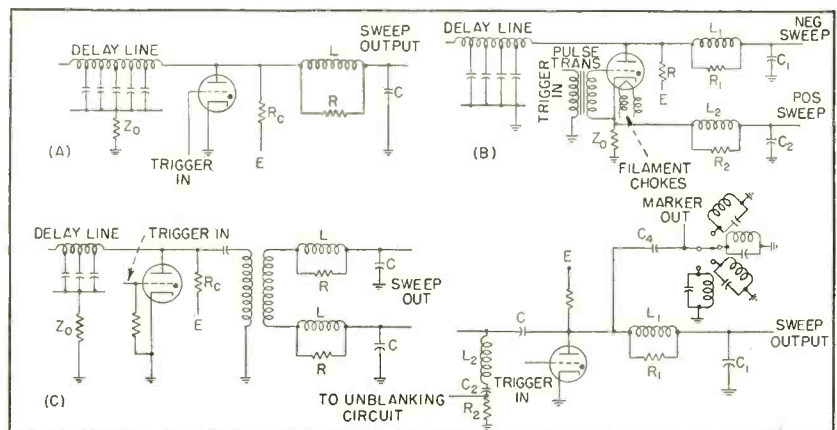

FIG. 2—Balanced and unbalanced sweep circuits for hydrogen thyatrons

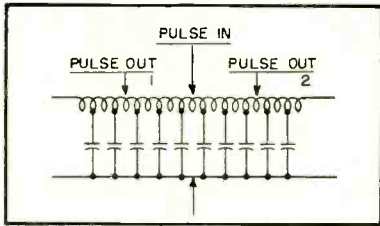

FIG. 3—Two-output delay line for initiating action observed and later, the scope sweep

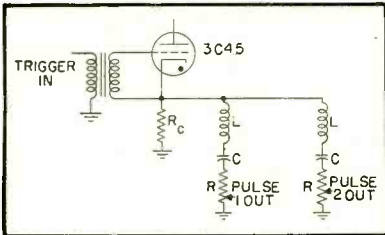

FIG. 4—Jitter is avoided by taking two outputs from cathode of thyatron

with the unblanking pulse, a small expansion sweep voltage is applied to the vertical deflection system so that several consecutive sweeps become distinguishable. This corresponds to a raster type of scan in that several sweeps may be made available at a given time.

One advantage of this type of sweep is that it provides stable delayed sweeps with no stable delay-pulse generation required. The time jitter of any sweep depends only upon the variation in the amplitude and frequency of the two-mc basic oscillator.

The jitter in the delay of the unblanking pulse used in this system does not result in time jitter in the trace itself, but is seen as fluctuations in the end of the interval being examined. This method works quite satisfactorily for sweeps longer than 0.5 μ sec. Above this speed, the generation of steep voltage slopes demands higher currents than can be conveniently obtained from vacuum tubes.

The rate of rise in volts per second of voltage across a capacitor is equal to the current divided by the capacitance.

$$\frac{i}{c} \left(\frac{\text{amperes}}{\text{farads}} \right) = \frac{dV}{dT} \left(\frac{\text{volts}}{\text{seconds}} \right)$$

If the sweeps are developed over the lowest possible capacitance consisting of the output capacitance of the sweep generator tube in parallel with wiring and cathode-ray tube capacitances, the current

which must be handled becomes objectionably high to be handled by a vacuum tube. For example, given a minimum capacitance of 30 μ mf and a rate of rise of 20,000 volts per μ sec, the current becomes 0.6 ampere.

In addition, the amount of cross coupling from one deflection plate to the next right-angle plate increases as the capacitance from plate to ground is lowered. This is due to the capacitance divider formed by the capacitance to ground and the plate-to-plate capacitance of the cathode-ray tube. If the capacitance from the deflection plate to ground is deliberately made as high as 100 μ mf to minimize cross-coupling effects, the current is increased to two amperes. This magnitude of current leads to the selection of a gas-filled tube such as the thyatron as a sweep generation source.

Several variations of the basic circuit for the development of

amplitude $E/2$ and length equal to twice the delay of the line, providing an unblanking pulse. The sharp drop at the plate is integrated by the RLC circuit to provide a substantially linear sweep voltage approximately equal to the supply voltage.

Associated with single-ended sweeps on electrostatic cathode-ray tubes there is an effect known as deflection defocusing which appears as progressive defocusing from start to end of the sweep. To correct this situation, two methods of producing balanced sweeps have been investigated. One method is illustrated by the circuit shown in Fig. 2B. The circuit is similar in operation to that previously described. When the thyatron is triggered, the cathode of the gas tube rises rapidly to a voltage $V/2$. In this way, C_2 charges to $V/2$ through L_2 and R_2 to provide a positive linear sweep approximately equal to $V/2$. Capacitor C discharges from V to $V/2$ to provide a negative sweep approximately equal to $V/2$. A positive square pulse of amplitude $V/2$ is developed across Z_0 so that an unblanking pulse may be obtained from the circuit.

Another method of obtaining balanced sweeps employs a transformer. In this circuit, Fig. 2C, the cathode of the gas tube is grounded, eliminating the necessity of filament chokes and the pulse transformer for keying purposes. Here the unblanking pulse is obtained across Z_0 and the sharp voltage step at the plate is capacitively coupled to the phase-inverting transformer. The voltage step is integrated from the secondary of the transformer to develop balanced sweeps. The linearity of these sweeps depends upon the frequency response of the transformer.

With the 5RP-A tube, deflection defocusing is not very serious and because of the possible simplification of circuitry, the single-ended sweep circuit shown in Fig. 2D is now used in this oscilloscope. The sharp voltage drop at the plate of the gas tube is integrated by L, R_1, C_1 to provide the sweep output.

The sharp voltage drop is also coupled by C_1 , a very small capacitor, to one of several tuned circuits

CRT Characteristics

Direct interelectrode capacitances	K1030	5RP-A
Deflection plate D_1 to D_2	0.52	1.8
Deflection plate D_3 to D_4	0.39	1.5
<i>Maximum ratings</i>		
Anode 2 to final intensifier	30,000 v	22,000 v
Typical deflection factor	128	140 \pm 20 percent

sweeps through the use of a hydrogen thyatron are possible. Figure 2A shows one form such a circuit may take. The tube may be a 2D21, 2050, 3C45, 4C35 or others.

This circuit operates as follows: with the thyatron in an unfired condition, the pulse-forming network is charged to voltage E through resistance R_c . When the trigger pulse is impressed upon the grid of the thyatron, the tube conducts and the voltage at the plate of the gas tube falls very rapidly to a voltage 20 to 50 volts above ground depending upon the tube used.

The charged line then discharges through the series circuit of Z_0 and the thyatron. This produces a negative square pulse across Z_0 of

in the grid circuit of the cathode-ray tube where a damped train of oscillations suitable for intensity markers is generated. The L_2 , R_2 and C_2 components produce a negative voltage pulse from which an unblinking pulse of sweep duration is formed.

Delay

When using an oscilloscope having high sweep speeds, the difficulty of maintaining the sweep in coincidence with the signal is considerable. To obtain a good presentation, the jitter should be kept less than one line width. This naturally applies to recurrent phenomena only since jitter from one sweep to the next is not recorded if individual sweeps are being photographed. Consider the case of the fastest sweep described, namely, $0.01 \mu\text{sec}$ per inch. Allowing for a spot size of 0.05 inch, this demands a jitter less than $500 \mu\mu\text{sec}$ for recurrent sweeps.

To obtain coincidence of sweep and signal, means must be provided to delay the sweep over the interval being examined. In the past, some variation of the circuit shown in Fig. 3 has been used. In this circuit a pulse is developed and fed into a delay line. This pulse traveling along the delay line is picked off at two points. A pulse with one delay is used to initiate the action to be observed, and a pulse at a second delay is used to initiate the oscilloscope sweep. These delays are so chosen that the transient to be observed occurs in the desired portion of the oscilloscope sweep.

An investigation of the keying characteristic of thyratrons has shown that with a d-c heater supply, a keying pulse supplied from a low-impedance source can provide

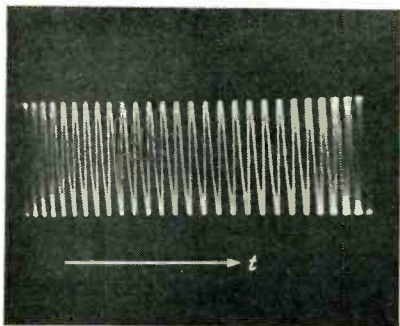

FIG. 5—Trace of a 120-mc keyed oscillator with a sweep of $0.05\text{-}\mu\text{sec}$ per inch

stable keying of a thyatron on a comparatively slow voltage slope. By decreasing the amplitude of this low-impedance pulse, the delay in firing the thyatron is increased.

Figure 4 shows a suitable source of low-impedance keying pulses. In this circuit two low-impedance pulses are obtained simultaneously from the same thyatron, thus assuring that no jitter exists between them. One pulse is used to trigger the thyatron sweep tube while the other is used to trigger the thyatron to be observed.

The values of L and C can be switched to furnish a rough adjustment of the delay in firing. For fine adjustment the amplitude of the keying pulse is changed by varying R . By means of suitable adjustment, the sweep tube and the tube under observation can be keyed simultaneously.

With this general type of circuit negligible jitter delays to $10 \mu\text{sec}$ have been obtained. To do this the values of L and C are such as to produce an approximate half sine-wave pulse of length equal to $20 \mu\text{sec}$. By suitable compensation within the gas-tube circuit as well as changes in the design of the thyatron the stable delay interval may be increased.

Calibration

The high-speed sweeps described were calibrated by several methods to find one accurate method suitable for both visual and photographic use.

Perhaps the most accurate method tried consists of using a crystal-controlled transmitter as a timing-wave source. The timing wave is applied to the vertical deflection plates and single-trace photographs taken. It has the disadvantage of not being synchronized with the sweeps and cannot be used to measure time directly when viewing recurrent phenomena.

A 120-mc oscillator was keyed and photographed, Fig. 5. This circuit is very stable and easily photographed since a considerable number of sweeps can be observed at one time.

A third method consists of ringing an inductance to produce a train of damped oscillations. This method is easiest to apply since a

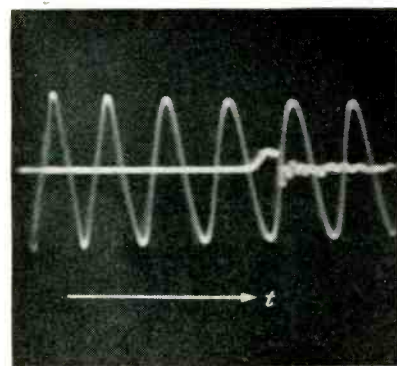

FIG. 6—Alternate keying of $0.005\text{-}\mu\text{sec}$ pulse and 50-mc timing wave

thyatron having high-current capabilities can be used for generating the oscillation. With the 3C45 the physical size of the tube appears to limit the frequency of oscillations to about 60 mc.

Figure 6 shows a 50-mc timing wave obtained from a ringing circuit superimposed on a $0.005 \mu\text{sec}$ pulse by alternate keying.

The oscilloscope is housed in a four-foot cabinet with component parts placed in three levels. The crt gun and deflection section are enclosed in a mu-metal shield to prevent magnetic fields from influencing the beam. The front of the tube is maintained at the final intensifier voltage by means of a copper band encircling the tube. To prevent corona and provide physical support for the tube, a Lucite collar is fastened to the front panel and supports the front of the cathode-ray tube. A sheet of $\frac{1}{8}$ -inch Lucite protects the observer from the high voltage. The high-voltage bleeder for obtaining the proper voltages for the intensifier elements consists of half-watt 1.8-megohm resistors wound in a spiral groove cut into a polystyrene rod to minimize corona effects. The total resistance is 100 megohms so that a 200-microampere meter may be used with the bleeder to read 20 kilovolts at full scale.

The limits on bandwidth and sweep speeds encountered in this oscilloscope are not a function of the circuitry. The frequency limitation is imposed by the cathode-ray tube and may be extended by a factor of four with use of the K1030 type tube. The available writing rate then becomes much greater and the circuitry may be extended to provide sweeps of much higher writing rates.

Calculating UHF Field Intensities

Curves based upon accepted propagation concepts facilitate theoretical prediction of television field intensities between 470 and 890 mc until more experience is obtained. Data on nulls and maxima resulting from path differences are included to show their location in miles from the transmitter

By **FREDERICK W. SMITH**

*Radio and Allocations Engineering
National Broadcasting Co.
New York, N. Y.*

THE RECENT allocations proposals by the FCC for commercial television broadcasting in the band from 470 to 890 mc have centered attention on propagation problems at these frequencies. In order to facilitate the prediction of theoretical ground-wave field intensities in this band, the group of charts presented here has been prepared.

The methods for the calculation of field intensities employed were originally proposed by Norton¹ and have been conveniently summarized by Terman.²

Field Near Transmitter

The equation for field intensities in the immediate vicinity of the transmitting antenna for the ultra-high frequencies under consideration is given by Terman³ as

$$\text{Field Intensity, } E = \frac{2 E_0 P^{\frac{1}{2}}}{d} \sin \frac{2\pi ha}{\lambda d} \quad (1)$$

where E_0 is the reference field intensity produced at a distance d of one mile for an effective radiated power P of one kilowatt, and h , a and λ are the heights of the trans-

mitting and receiving antennas and the wavelength, respectively.

The reference field intensity selected by the FCC as an f-m and tv standard is that developed in the equatorial plane of a half-wave antenna under the conditions specified above, or 137.8 millivolts per meter. Such an antenna has a power gain of 1.641 when compared to an isotropic radiator.

Using this value for E_0 and substituting 186,200 miles per sec \div f or (c/f) for λ , with h and a in feet and f in megacycles, Eq. 1 can be reduced to

$$E = \frac{275,600}{d} P^{\frac{1}{2}} \sin \theta \text{ microvolts per meter}$$

where $\theta = 6.92 \times 10^{-5} haf/d$ degrees (2)

It can be seen from Eq. 2 that for a fixed distance and receiving antenna height, a single value of field intensity will result for a given frequency-transmitting antenna height fh product. Thus, where Eq. 2 applies, a transmitting antenna height of 1,000 feet at 450 mc will produce the same field intensity as 500 feet at 900 mc, other factors being equal.

This relationship has been employed to simplify the construction of the field-intensity chart, which is similar in many respects to previous charts published by the FCC for field-intensity calculations in the vhf band. Here, the product fh serves as the independent variable, which permits the use of a single chart for the entire frequency band under consideration.

Phase Interference

Near the transmitting antenna, a series of oscillations will occur in the field intensity as a result of phase interference due to differing path lengths traversed by the space wave and ground-reflected wave components of the signal. This effect is indicated by the sine term of Eq. 2, which will oscillate between unity and zero in value as θ reaches successive values of 90, 180, 270 degrees, and so on. The nulls and maxima thus produced will become much more frequent with decreasing distance. However, the latter will always be tangent to a curve along which the field intensity var-

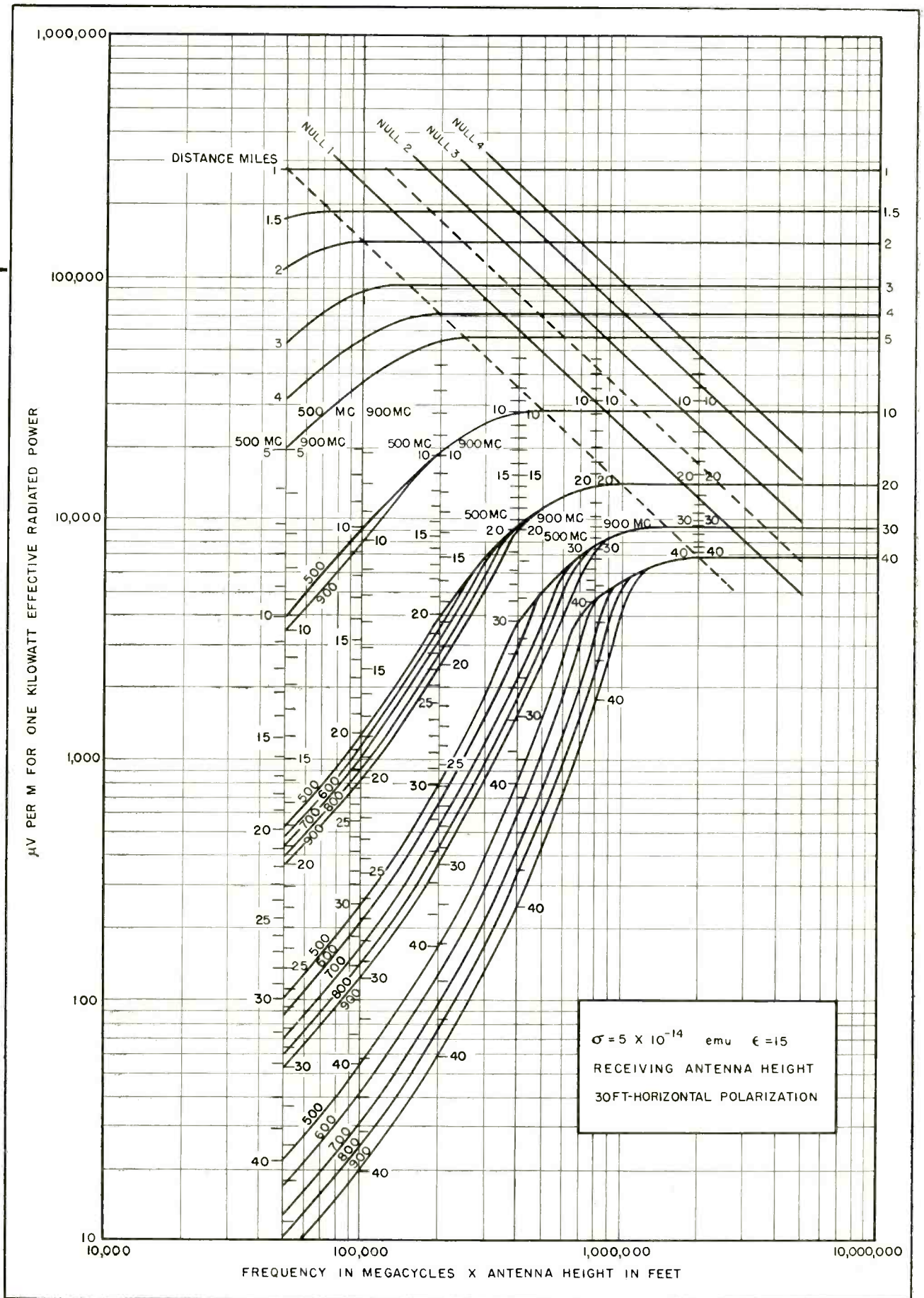

FIG. 1—Theoretical ground-wave signal range for 470 to 890 mc

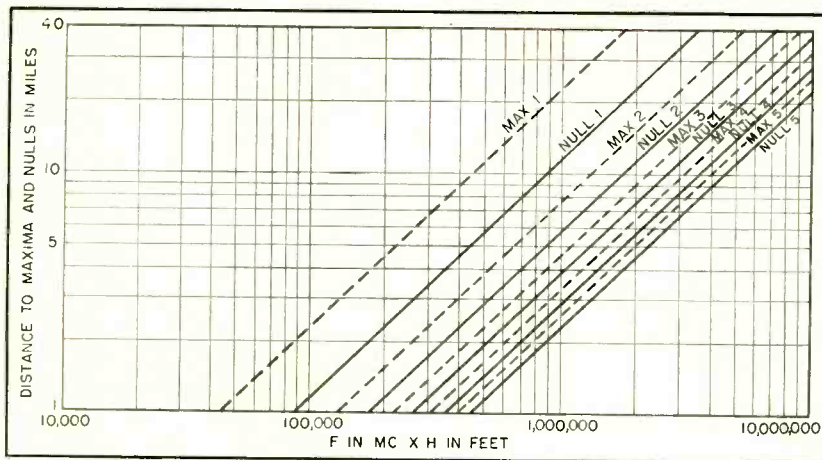

FIG. 2—Distance in miles to maxima and nulls

ies inversely with distance. Such a curve can therefore serve as a guiding upper limit when the graph is used to secure a plot of E as a function of d .

The approximate distances at which the above mentioned nulls occur for various fh products can be estimated from the null lines that have been drawn for the first five nulls. These null points may be more exactly determined from the smaller graph, Fig. 2, which represents the distance to the various maximum and null points as a function of fh . The dotted lines adjacent to the first null line in Fig. 1 serve to indicate the points at which the field intensity curves will start to fall from and return to the inverse distance curve on either side of the first null, giving some idea of the behavior of the field-intensity curves in a null region.

As the transmission distance increases, nulls cease to appear, and field intensities will progressively diminish, varying as the inverse square of the distance when θ has decreased to 20 degrees or less. This is seen in Eq. 2 where $\sin \theta$ may be replaced by θ itself for the values of θ just mentioned, causing d to be squared in the denominator.

Equation 2 may be used with accuracy until θ equals ten degrees, or until the radio line-of-sight horizon has been reached. Beyond these limits a different expression must be employed which provides field intensities in the diffraction region where the receiving antenna is below the line-of-sight. In order to obtain the continuous curves that

appear in Fig. 1, smooth transition curves were drawn between the field strengths calculated for line-of-sight conditions and the field strengths calculated for the diffraction region.

It should also be noted that values shown in Fig. 1 for fh products of 10^6 or more are approximate only.

Diffraction Region Fields

Field intensities in the diffraction region where the receiving antenna is below the line-of-sight are computed by means of an expression due to Norton and given by Terman⁴ as:

$$E = F_1 F_2 E_{su} \quad (3)$$

where E_{su} is the surface wave intensity at the point on the earth's surface below the receiving antenna as calculated from Eq. 10, par. 2 of the same reference⁴, and F_1 and F_2 are the appropriate height factors for the transmitting and receiving antennas as given by Eq. 20, par. 3 of the source above.

It is apparent from Fig. 1, that in the diffraction region the frequency-height product relationship no longer holds, and as a result separate distance scales have been provided for 500 and 900 mc, with the addition of curves for 600, 700, and 800 mc at the 20, 30 and 40-mile points as an aid to interpolation.

Prediction Vs Measurement

Unfortunately, the theoretical calculation of field intensities at these frequencies fails to take into account various factors such as terrain irregularities, shadowing or phase differences in signals arriv-

ing at a given point by multipath propagation. Also neglected are effects important at larger distances such as fading, day-to-day variations due to changes in the refractive index of the atmosphere, and tropospheric reflections.

Initial uhf field measurement surveys in the New York⁶, and Washington^{6,7} areas have indicated that actual uhf field intensities observed are likely to be lower than those predicted theoretically. However, it is evident that much more investigation will be required before local deviations from the theoretical can be predicted with any accuracy.

Using the Chart

The field intensities developed at any distance up to forty miles for one kilowatt of effective radiated power may be read directly from the ordinate of Fig. 1 for any frequency-transmitting antenna height product along the abscissa. For example, an fh product of 100,000 will produce approximately 54 millivolts per meter at a distance of four miles for an erp of one kw for all frequencies in the band, and at thirty miles, 253, 212, 170, 141 and 124 microvolts per meter for 500, 600, 700, 800 and 900 mc respectively.

For other values of P , the ordinate scales must be shifted in proportion to P^3 as is done when using the charts published by the FCC for the vhf bands.

Where Eq. 2 is valid, Fig. 1 may be compared directly with the FCC curves. Citing the same example, at a distance of four miles, 54 millivolts per meter will also be obtained from the FCC curves for 82 mc at 1,220 feet, 98 mc at 1,020 feet and 195 mc at 513 feet.

REFERENCES

- (1) K. A. Norton, The Calculation of Ground-Wave Field Intensities over a Finitely Conducting Spherical Earth, *Proc. IRE*, 29, p 623, Dec. 1941. See also FCC Report 39920, March 18, 1940.
- (2) F. E. Terman, "Radio Engineers' Handbook," McGraw-Hill Book Co., 1943, sec. 10, par. 1, 2 and 3.
- (3) Reference 2, sec. 10, par. 3, Eq. 24 (b).
- (4) Reference 2, sec. 10, par. 3, Eq. 18.
- (5) G. H. Brown, J. Epstein, and D. W. Peterson, Comparative Propagation Measurements: Television Transmitters at 67.25, 238, 510 and 910 megacycles. *RCA Review*, 9, No. 2, June 1949.
- (6) G. H. Brown, Field Test of Ultra-High-Frequency Television in the Washington Area. *RCA Review*, 9, No. 4, Dec. 1948.
- (7) J. Fisher, Field Test of UHF Television, *ELECTRONICS*, p 106, September 1949.



**In EMERGENCIES...
National and
Individual**

... Cinch

is the industry's recognized source headquarters for sockets, shields, plugs, jacks, terminals, connectors, Standard Electronic components. It's Engineering Department under stress of the urgency of need and limitations in time has produced many "firsts", original designs that later became standard in use. And its reputation of meeting effectively many electronic component problems of the past quarter century is evidence that Cinch's Engineering Department is able and ready, today, to serve you.

Cinch invites you to submit your specific need for immediate consideration and recommendation.

Available at leading electronic
jobbers — everywhere.

CINCH MANUFACTURING CORPORATION

1026 South Homan Ave., Chicago 24, Illinois

Subsidiary of United-Carr Fastener Corporation, Cambridge, Mass.



Cinch
ELECTRONIC
COMPONENTS

Cathode Follower Response

Chart gives permissible cathode-follower pulse drive at video frequencies in terms of low-frequency sinusoidal input. Video-frequency overloading and distortion in conventionally loaded circuits originate in output time constant

By **RALPH H. BAER**

Chief Engineer
Wappler, Inc.
New York, N. Y.

CATHODE FOLLOWERS frequently overload and distort on video signals when designed on the basis of low-frequency formulas. This behavior results from the effect of the time constant associated with

the output impedance of the cathode follower and the load capacitance. The usual formula for the peak signal permissible is

$$e_{\sigma \text{ peak}} = \frac{E_B}{\mu} \left[\frac{1 + \frac{R_k}{R_p}(\mu + 1)}{\frac{R_k}{R_p} + 2} \right] \quad (1)$$

which is readily calculated. Inspection of Eq. 1 shows that medium values of μ (15-30) are

desirable for maximum permissible input signal.

When a video signal with rise time t microseconds is applied to a cathode follower this permissible grid swing is reduced by a factor of

$$1 + \frac{\frac{R_k}{R_p}}{\frac{R_k}{R_p} + 1} \left(\frac{1 - e^{-\frac{t}{T}}}{\frac{t}{T}} \right) \quad (2)$$

where T is the time constant. Whenever T approaches the pulse rise time in order of magnitude, the reduction in permissible grid signal can no longer be neglected and the correction factor of Eq. 2 becomes essential.

The graph is a solution of Eq. 2; the following procedure applies when a pulse waveform of rise time t is to be handled without distortion where

$$T = \frac{C_T R_k}{1 + g_m R_k}$$

(a) Determine the value of R_k/R_p and t/T . (b) On the graph, connect R_k/R_p with μ . (c) At the intersection of line A with the line drawn in step (b), read vertically up or down to the proper t/T curve. The solution is then obtained from the percent scale by reading horizontally to the left.

As an example, consider a tube with $\mu = 40$, $R_p = 20,000$ and a load impedance of $R_k = 1,000$ and $C_t = 250 \mu\mu\text{f}$ in parallel. From Eq. 1 $e_{\sigma \text{ peak}} = 5.6$ volts for $E_B = 150$ volts. Suppose a video signal with rise time $t = 0.42 \mu\text{sec}$ is handled by the cathode follower. Then $T = 0.0834 \mu\text{sec}$ and $t/T = 5$. From the graph the permissible peak signal is seen to be 72.3 percent of $e_{\sigma \text{ peak}}$ at low frequencies, or 4 volts.

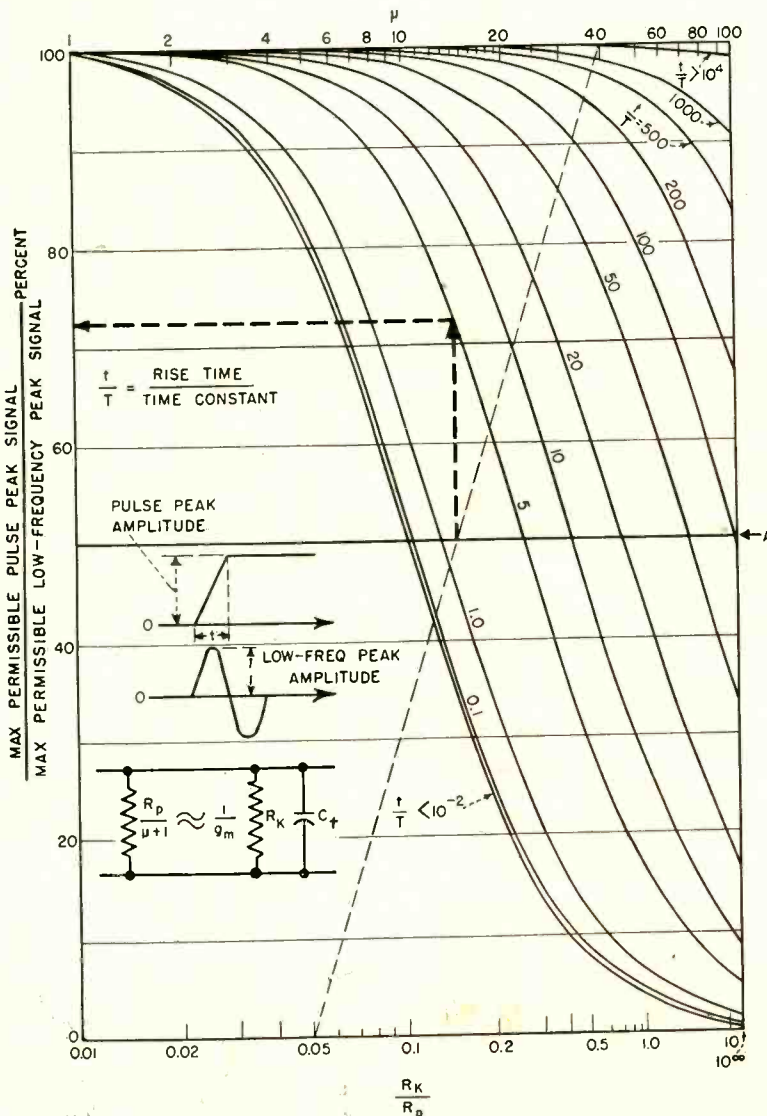



MALLORY VIBRATORS

Mallory Vibrators are based on exclusive design and manufacturing methods that assure long, trouble-free service. Send the details of your application. Get Mallory's recommendation on the Vibrator or Vibrapack* power supply best suited to your needs.

Mallory Vibrators Roll Up Big Savings... Protect Customer Good Will!

Reducing component parts costs—and at the same time, improving performance—is a welcome combination! The economy and dependability of Mallory Vibrators have made important contributions of this kind for Mallory customers.

Here's just *one* example! A radio manufacturer was receiving serious field complaints on vibrator performance. The substitution of two Mallory Vibrators—one a standard type, and the other especially designed for his problem—not only eliminated the difficulty but saved the customer \$30,000 in vibrator costs alone! And the changes were accomplished with virtually no modification in circuit designs.

That's service beyond the sale!

And whether your problem is electronic or metallurgical what Mallory has done for others can be done for you.

Vibrators and Vibrapack* Power Supplies

P. R. MALLORY & CO., Inc.
MALLORY

P. R. MALLORY & CO., Inc., INDIANAPOLIS 6, INDIANA

SERVING INDUSTRY WITH

Capacitors	Contacts
Controls	Resistors
Rectifiers	Vibrators
Special	Power
Switches	Supplies
Resistance	Welding Materials

*Reg. U. S. Pat. Off.

TUBES AT WORK

Including INDUSTRIAL CONTROL

Edited by VIN ZELUFF

Automatic Audio Level Alarm.....	116
Low-Frequency Generator.....	116
Blocking Oscillator Time Base.....	118
Coaxial Feed System for Antennas.....	154
British Developments in Instrumentation.....	182

Automatic Audio Level Alarm

BY N. HAGMANN
Station Engineer
Radio Station WJZ
Lodi, N. J.

ONE of the many things to which a broadcast station engineer must pay careful attention is program level and quality. Because rather large variations in level are not easily detected by ear, particularly if the engineer is occupied with other allied work, an automatic alarm system becomes a practical necessity. Such a device is particularly valuable when more than one transmitter carrying the same program material must be monitored.

The audio alarm used at this station is fed through a bridging transformer from the audio source to a 6K6 amplifier stage. This tube feeds into a cascaded diode rectifier, a type 6H6, that separates the

diode load circuit from the control circuit. Load resistor R_5 in the cathode of the 6H6 is used to adjust the level of audio to be rectified.

The plate of the same tube feeds the cathode of the second 6H6 section and acts as a d-c separation circuit. The plate of the second section charges a large capacitor that bleeds off through resistors R_6 , R_7 and R_8 with R_{11} the controlling element. The grid of the 2050 is connected to the junction of R_6 , R_7 and R_{11} . The plate circuit of the 2050 contains the a-c alarm relay. A type 6E5 tuning-eye tube facilitates adjustments for proper level and time delays R_{10} and R_{11} , respectively.

In operation, the 2050 gas tube is made conducting by the rectified signal on its grid stored by the 20-microfarad capacitor. This signal results from the charging effect of the audio input. The proper reference level is set by potentiometer

R_{10} that effectively biases the gas tube. Failure of the audio signal, after an appropriate time delay set by R_{11} , results in the relay being de-energized and closing the alarm circuit through its back contacts. A disabling switch in the alarm circuit is useful during symphonic or similar programs in which wide dynamic range is encountered.

The unit can be fed from either audio program lines or the output of an r-f monitor. In the latter case, failure of either the program or the carrier will be detected.

Low Frequency Generator

BY W. G. SHEPARD
Physical Research Unit
Boeing Airplane Co.
Seattle, Washington

THE GENERATION of sine waves by ordinary electronic means becomes increasingly difficult as the frequency is lowered below 10 cycles. The phase-shift circuit is generally used but elaborate care in design and construction is necessary to achieve satisfactory performance. Since a multivibrator is a more dependable low-frequency oscillator, operating down to almost any slowness, it was decided to use the output wave of a multivibrator and shape it into essentially a sine wave.

First a large square-wave voltage was generated by triggering an Eccles-Jordan flip-flop circuit from the multivibrator, this being easily done because the triggering signal can be applied to both grids. By incomplete integration, essentially a triangular wave is obtained. Since this wave contains no even harmonics and only 1/9 third and even less higher harmonics,

$$Y = 8/\pi^2 E(\cos x + 1/9 \cos 3x + 1/25 \cos 5x \dots)$$

a simple filter system will reduce the harmonics to negligible value.

Such a sine-wave generator is most easily constructed for a single frequency and is not very well suited for continuously variable frequencies over a wide range because of the increasing attenuation of the filter as the frequency is raised. However, it is quite feasible to construct a unit covering a num-

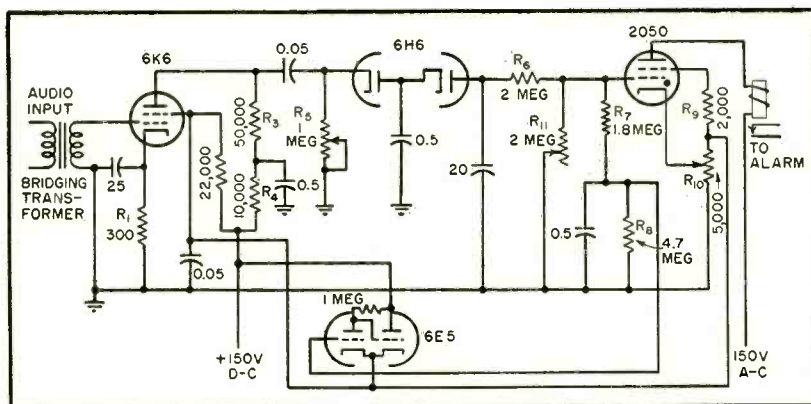
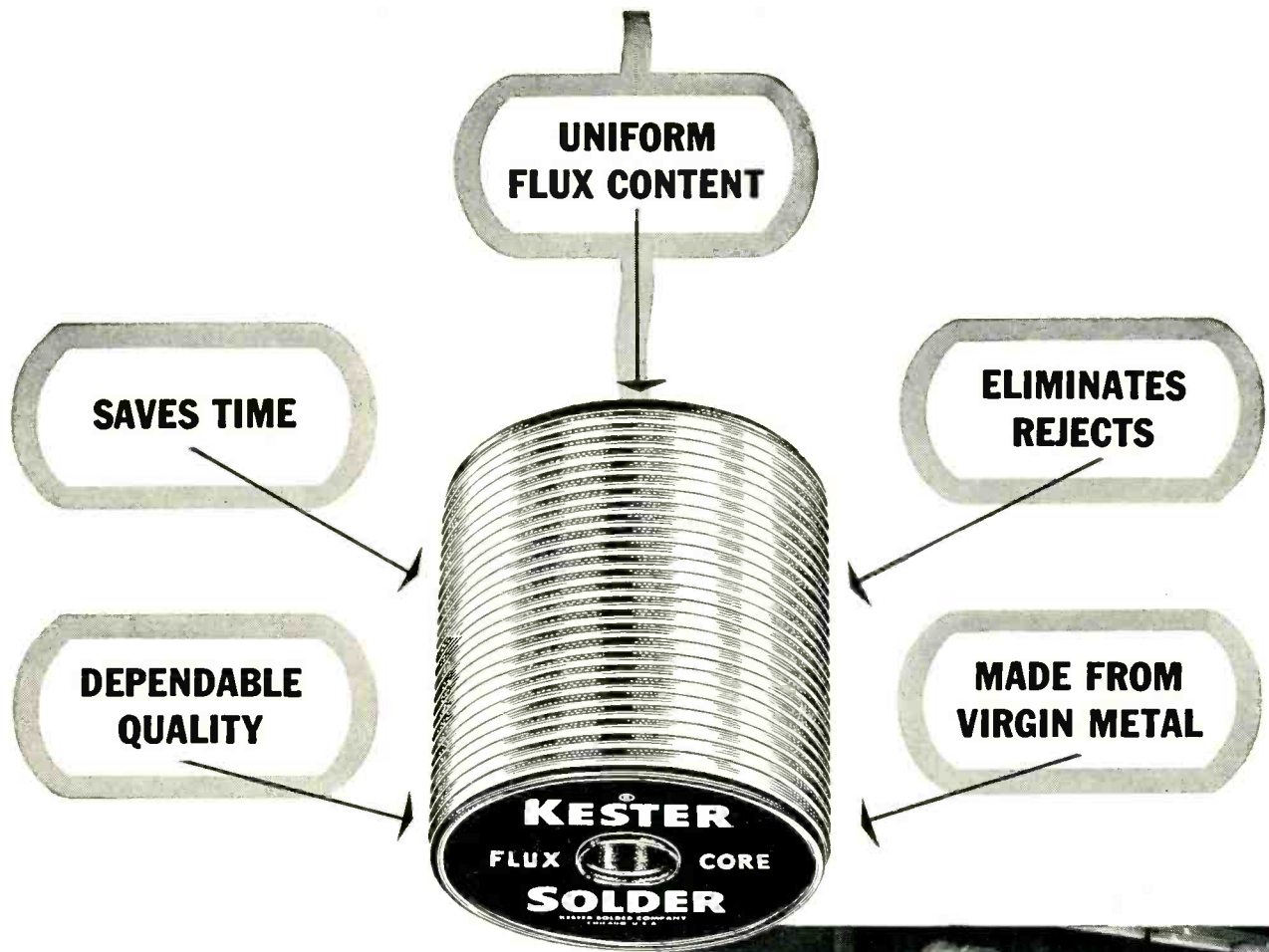
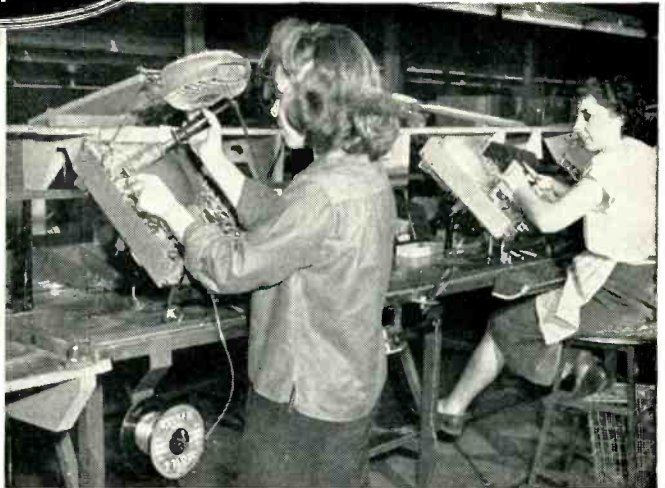

FIG. 1—Diagram of the audio failure alarm. Potentiometer R_{10} sets the level at which the gas tube fires, R_{11} controls time delay between loss of audio and sounding of alarm, and R_5 sets level of audio into the device



KESTER
the Solder

*that gets Speed
into
TV Production*



Using Kester Flux-Core Solders, Plastic-Rosin and "Resin-Five" Core Solders, will keep your solderers satisfied. Kester flows better—handles easier—faster to use. Kester Solders are made only from newly mined grade A tin and virgin lead.

FREE TECHNICAL MANUAL—Send for your copy of SOLDER and Soldering Technique.

KESTER SOLDER COMPANY • 4204 WRIGHTWOOD AVE.
CHICAGO 39, ILL. • NEWARK, N. J. • BRANTFORD, CANADA

Kester "Resin-Five" Core Solder and Plastic Rosin-Core Solder, which are available in the usual single-core type, can now also be had in a 3-core form.



THE FRONT COVER

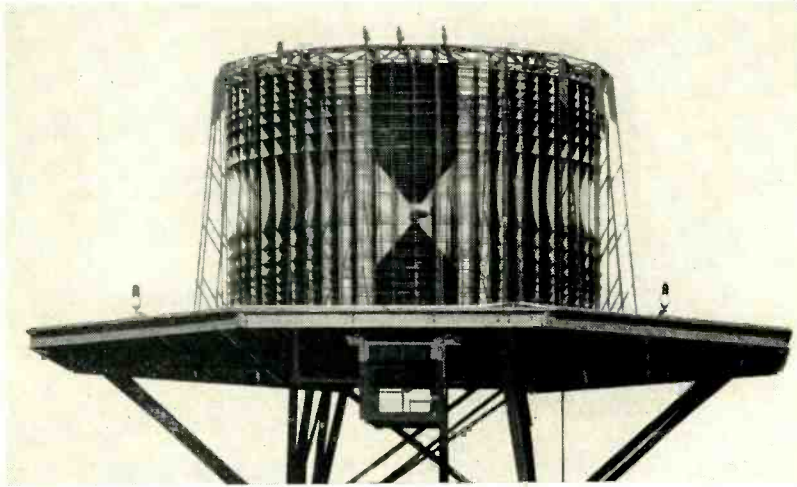

PRECISION omni-range equipment, of which the tower shown on the front cover is a part, has made possible significant increases in air terminal capacity. The new equipment, introduced by Sperry Gyroscope Co., operates in the 5,000-mc region. The photograph shows the microwave lens which performs a function similar to the Fresnel lighthouse lens. The sharp vertical pattern it forms increases accuracies to within one-half degree, by virtually eliminating ground reflections at all angles greater than approximately $\frac{1}{2}$ degree above the horizontal. This represents an altitude of about 1,000 feet at the edge of the control zone. Thus the signal is free from ground reflections in the operating region.

ber of fixed frequencies selected by means of a suitable switching arrangement.

Figure 1 shows the diagram of such a circuit as constructed for calibration purposes. Type 6J6 tubes are employed in the multi-

brator and flip-flop circuits, the multivibrator receiving its plate supply from a regulated source for greater frequency stability. Capacitor C_3 and R_3 form the triangular wave and V_3 is a cathode follower inserted to lower the impedance.

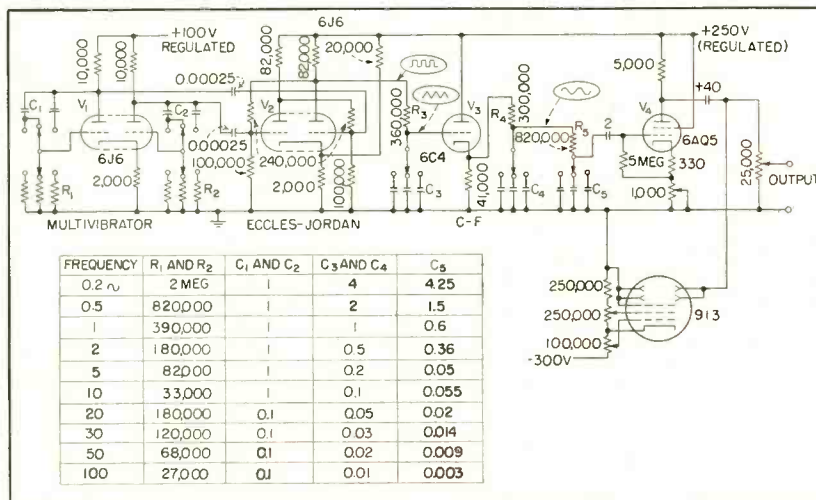

FIG. 1—Schematic of sine-wave generator producing frequencies from 0.2 to 100 cycles

Two filter circuits, C_1R_1 and C_5R_5 , are so proportioned that the third harmonic is attenuated in each about three times as much as the fundamental, leaving about one or two percent third and practically no higher harmonics. For simplicity only three switch positions are shown in the diagram, but values are given in the table for 10 frequencies. These are the values actually used and differ somewhat from calculated values. The value of C_5 was chosen experimentally to give approximately the same voltage output for each frequency. The cathode circuit of V_1 contains a control allowing for further minor adjustments in output voltage. The output voltage, after being amplified by the 6AQ5 tube, is about 14 volts at the input to the attenuator.

Since the generator, as constructed, is used for calibration work, some method was necessary to make sure that the output voltage is approximately the same for each frequency. Since the frequency is too low for the use of a meter, a small cathode-ray tube is used as an amplitude indicator. The vertical and horizontal plates are tied together to increase the sensitivity of the tube. Since this causes the spot to move back and forth diagonally, the tube must be rotated 45 degrees to give a horizontal spot movement.

Blocking-Oscillator Time Base

By LAWRENCE FLEMING
510 N. West St.
Falls Church, Va.

BLOCKING OSCILLATORS, commonly used for fixed-frequency time-base generators, can be used to provide very satisfactory oscilloscope time bases.

A blocking oscillator with positive grid bias is shown schematically in Fig. 1. It has an upper frequency limit higher than obtainable with gas triodes; its cost is low, the tube being an ordinary dual triode and the oscillator coil small and simple; a single variable resistor provides fine-frequency adjustment; the output waveform is

(Continued on p 150)



EXILED...

for probing the unknown!

"For practicing black magic, consorting with the devil, and spreading dangerous thoughts against the laws of man and nature, you are exiled forever!"

This was the import of the fateful words heard by Galileo Galilei, facing a court of inquisition in the 16th century. Scorned and ridiculed, the great mathematical and astronomical genius went to his exile an old and broken man, a brilliant, searching mind no longer permitted to probe the mysteries of the universe.

Today, free men of science labor under no such restriction. Analysis and proof are the tools employed in this enlightened era to obtain for them a hearing . . . an opportunity to substantiate their theories.

In the modern laboratories of the Sprague Electric Company, a research staff of physicists, engineers, and chemists, second to none in the electronic parts industry, is constantly striving to attain the ultimate in electronic components. Like others of their profession, they are helping to forge a level of scientific development about which Galileo, the great researcher, "born before his time", could only dream.

SPRAGUE

SPRAGUE ELECTRIC COMPANY
North Adams, Massachusetts

PIONEERS

IN ELECTRIC AND ELECTRONIC DEVELOPMENT

SUBMINIATURE PROKAR® CAPACITORS are designed especially for high-quality, minimum-size electronic equipment which must operate dependably under the most severe conditions.



Made by an exclusive Sprague process . . . molded in a mineral-filled, high temperature plastic . . . these tiny but tough capacitors are ideal for -55°C to $+125^{\circ}\text{C}$ operation.

THE ELECTRON ART

Edited by JAMES D. FAHNESTOCK

Ionosphere Winds Charted from Meteor Echoes	120
Metallized Paper Capacitors	122
British Cinderadiograph Apparatus	222
Single-Tube Audio Phasemeter	226
NRL Microwave Interferometer	236
Ultrasonics Used In Seed Treatment	238
Direct-Reading R-F Wattmeter	240

Ionosphere Winds Charted from Meteor Echoes

IONOSPHERIC WINDS, 55 to 80 miles above the earth, have been measured by analyzing the drift of meteor ion trails.

Wind velocity, which may range from 30 to 125 mph, is determined by use of the Doppler effect. Doppler recordings have been made using a 23.1-mc c-w transmitter, the beat difference between the transmitted and reflected signals being used to determine wind velocity. In addition, a 17.3-mc pulse transmitter has been used for ranging on the ion trails.

Wind direction is determined through the use of a special meteor direction finder. Four vertical an-

tennas are spaced about a vertical reflector as shown in the photograph. Each radiates through a single quadrant. The antenna pattern is swept electronically. Presentation involves sixteen vertical A-scan traces on a horizontal trace.

This research, carried on at Stanford University and financed by the Office of Naval Research, is expected to have useful applications both in the design of long-range guided missiles and in weather forecasting.

Irregularities Noted

Although each ion trail lasts only a second or two, the average motion

of the upper atmosphere air mass is determined by averaging many measurements. In addition to this average motion, evidence of irregularity in the nature of the wind has been reported.

The meteoric ion trails are usually observed to drift at speeds of 200 mph, although the air mass as a whole moves several times more slowly. It is not yet clear whether these irregularities are the result of local turbulences or of separate layer-like winds blowing in different directions at different altitudes.

The measurements show that during July and August last year, the winds in the outer atmosphere were predominately from the south-south west, with some winds from the north, and a few weaker winds blowing west to east.

The bright flashes seen in the night sky by the naked eye are caused by particles of matter about the size of a small pea. Smaller, more numerous particles produce weaker flashes not visible to the human eye and are easily detected by electronic methods.

Continuous Readings

Radio equipment can detect these tiny meteors both day and night, so the ion trail method of wind measurement is potentially capable of giving continuous wind readings.

Thus far measurements have been made only during the early

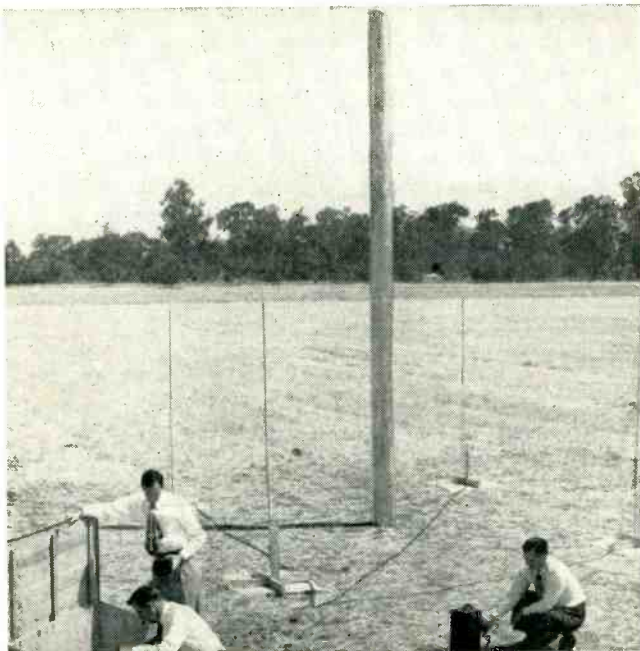

Meteor direction finder uses four vertical antennas spaced around a single vertical reflector



Doppler beats between transmitted and reflected c-w signals are recorded on tape to furnish wind-velocity data

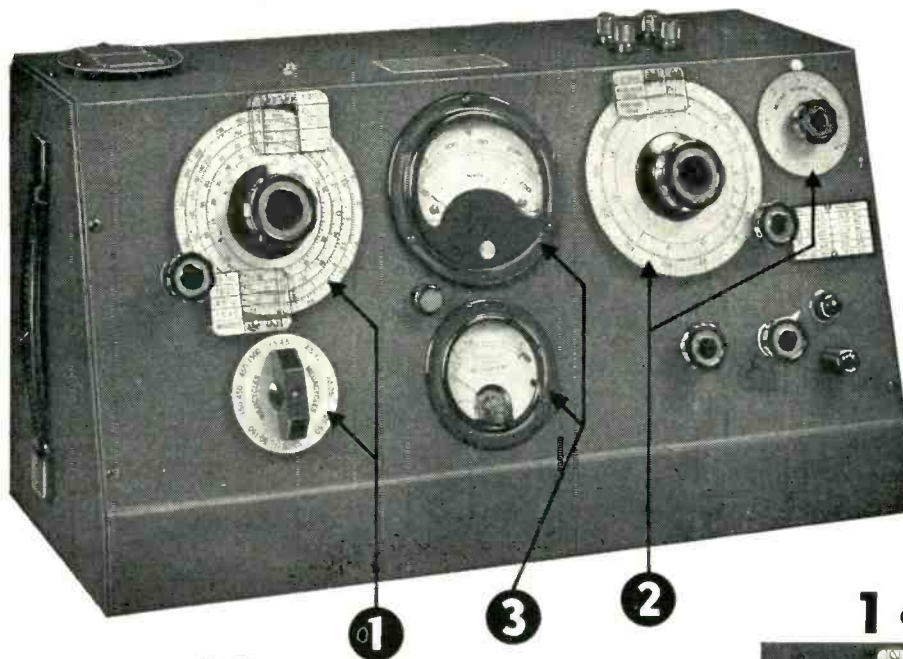

EXAMINE THESE
*Direct Reading
Features*
WHICH SIMPLIFY
ACCURATE MEASUREMENTS

The Q-METER

TYPE 160-A

50 kc. to 75 mc.

Radio frequency circuit design often requires the accurate measurement of Q, inductance and capacitance values. For this application the Type 160-A Q-Meter has become the uncompromising choice of radio and electronics engineers in this country and abroad.

Each component part and assembly used in the manufacture of this instrument is designed with the utmost care and exactness. Circuit tolerances are held to values attainable only in custom built instruments.

With the 160-A Q-Meter, as with other Boonton Radio Corporation instruments, the keynote in design is to embody accurate *direct reading* features which save time and simplify operation.

SPECIFICATIONS

Oscillator Frequency Range: 50 kc. to 75 mc. in 8 ranges.

Oscillator Frequency Accuracy: $\pm 1\%$, 50 kc.—50 mc.
 $\pm 3\%$, 50 mc.—75 mc.

Q Measurement Range: Directly calibrated in Q, 20-250. "Multiply-Q-By" Meter calibrated at intervals from x1 to x2, and also at x2.5, extending Q range to 625.

Q Measurement Accuracy: Approximately 5% for direct reading measurement, for frequencies up to 30 mc. Accuracy less at higher frequencies.

Capacitance Calibration Range: Main capacitor section 30-450 mmf, accuracy 1% or 1 mmf whichever is greater. Vernier capacitor section ± 3 mmf, zero, -3 mmf, calibrated in 0.1 mmf steps. Accuracy ± 0.1 mmf.

Catalog "H" containing further information available upon request.
(In Canada, direct inquiries to RCA Victor Co., Ltd., Montreal.)

DESIGNERS AND MANUFACTURERS OF THE Q METER • QX CHECKER
FREQUENCY MODULATED SIGNAL GENERATOR • BEAT FREQUENCY
GENERATOR AND OTHER DIRECT READING INSTRUMENTS

1 OSCILLATOR FREQUENCY DIAL.

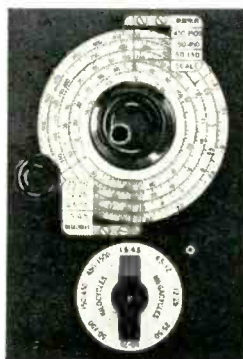

This large $4\frac{1}{2}$ " open faced dial has eight overlapping frequency ranges, each calibrated *directly* in kilocycles or megacycles, with scales conveniently divided for maximum readability. A vernier dial drive enables fine settings to be made with ease. All frequency ranges are accurate to within $\pm 1\%$ except the 50-75 megacycle range which is accurate to $\pm 3\%$. The clearly marked range change switch located directly beneath the frequency dial facilitates rapid and positive selection of the desired frequency band.

2 Q-TUNING CAPACITANCE DIALS:

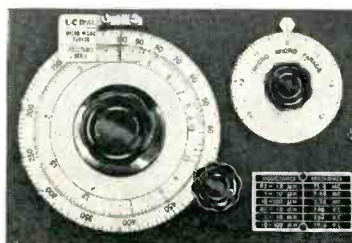

L-C dial serves twofold purpose of (1) conveniently and accurately indicating tuning capacitance *directly* in MMF, and (2) providing an effective inductance scale which also becomes *direct reading* at certain defined frequencies shown on frequency reference plate. Incremental capacitance dial at right calibrated from $+3$ MMF through zero to -3 MMF, accurate to ± 0.1 MMF.

3 Q-VOLTMETER AND MULTIPLIER METER.



For the indication of Q values the 160-A Q-Meter employs a Weston Model 643 Meter calibrated *directly* in terms of Q over the range from 20-250. The damping of the meter movement is ideal for the rapid determination of exact resonance without sluggishness or overshoot. The lance type pointer enables Q readings to be obtained to the nearest unit. Located directly beneath the Q voltmeter is the "Multiply-Q-By" meter which provides Q multiplier factors of X1 to X1.5 in 0.1 steps, X2, and X2.5 thereby extending the useful range of Q indication to 625. This meter is carefully matched to a particular thermocouple element for maximum accuracy.

BOONTON RADIO
BOONTON • N. J. • U. S. A. Corporation



morning hours when radio conditions are best. Improved equipment, which is just being put into service, is expected to extend the measurement schedule around the clock.

By a further extension of the technique it is believed, that winds at selected heights in the 55 to 80-mile altitude range may be measured.

The meteor drift method is the first to offer the possibility of continuously measuring winds at different altitudes. Other radio wind-measuring methods have recently been devised in the United States and England, but they depend on the regular ionosphere layers and so are restricted to specific heights. Wind measurements made during high-altitude rocket flights are expensive and restricted to a few

minutes duration at the most.

Knowledge of the high altitude winds gives information as to the composition of the upper atmosphere. This information is of value to high-altitude aircraft designers in connection with airfoil design; and it is particularly useful to weather forecasters because weather predictions must be based on the most complete possible knowledge of the atmosphere.

Field tests carried out simultaneously with measurements at Stanford served to confirm the reality of the wind-drift effect and showed that the same meteor disturbances could be detected simultaneously at two locations as much as 50 miles apart. Valuable data on the composition of a given meteor trail at different points along its length was also obtained in these tests.

Metallized Paper Capacitors

By JOHN H. FISHER

Vice-President in Charge of Engineering
Astron Corporation, East Newark, N. J.

THE CONCEPTION of a metallized paper capacitor dates back to approximately 1900. However, developments at this early stage of the art were stymied mainly by the inability to obtain a uniform and continuous metal coating on thin paper. The basic principle was proven sound by Robert Bosch of Stuttgart, Germany during World War II when he developed a practical evaporation process for coating paper with a thin uniform film of zinc. The zinc is placed in a high-vacuum chamber and its temperature is raised to about 350 degrees C. The gaseous vapors given off then condense on the relatively cool paper surface in the chamber.



Actual-size reproduction of metallized paper foil, showing holes left by self-healing action

Under the right conditions of vacuum and temperature the result is a homogeneous metallic coating 50 millimicrons in thickness.

Bosch found zinc most suitable for his purpose because of its low vapor pressure of 10^{-2} mm Hg at 350 C, which gave him no refractory difficulties during the process. It was found, however, that zinc is somewhat limited for capacitor applications, chiefly because of its high power factor which limits it to d-c applications. It is also difficult to obtain a strong lead connection to the zinc-coated paper section of small capacitors.

A practical method was developed in England for the vaporization



Top to bottom: Conventional 0.1- μ f molded paper capacitor; corresponding metallized unit; hermetically sealed metallized unit

of aluminum on paper, using a vacuum of 3 to 4 microns and a temperature of 1,500 C. The thin uniform coating of aluminum permits use of a single-sheet dielectric and gives a small, compact and light-weight capacitor unit with revolutionary selfhealing characteristics.

Prior to metallizing the paper is continuously coated on one side with a thin film of lacquer material consisting of a 10-percent solution by weight of cellulose acetate, to increase the dielectric strength and insulation resistance of the paper.

Selfhealing Action

Metallized paper capacitors can be subjected to intermittent over-voltages and surges without danger of failure. If surges are of short duration, the capacitors can safely stand surges of 2 to 2½ times their operating voltage. As the temperature is increased the tendency to spark increases and the breakdown point of the capacitor is lowered. When the capacitor is overstressed, any incipient weakness in the dielectric is burned out. Actually the aluminum coating on the paper is melted by the spark discharge caused by the puncture, whereupon the molten metal is blown away from the hole by the arc, leaving a metal-free area around the puncture. The area thus made has a high surface resistance so that the overall insulation resistance of the capacitor is only slightly lowered. In most circuits, reduced in-

(Continued on p 214)

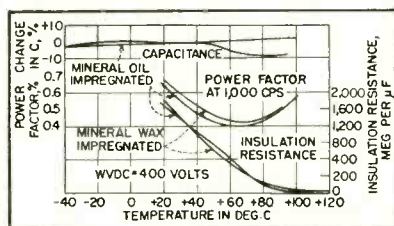

FIG. 1—Variation of electrical characteristics with temperature for metallized paper capacitors

The tape goes 'round and 'round...

*smoothly, swiftly—
at higher winding
machine speeds*

It's Kodapak Sheet

... choice of leading
electrical manufacturers
for primary wire
insulation

In general: Kodapak Sheet is available in various forms including Kodapak I Sheet, cellulose acetate, gauges up to 0.060"; Kodapak II Sheet, cellulose acetate butyrate, gauges up to 0.002". Of the two, the latter is preferred for many electrical applications because of its high dielectric strength, its superior resistance to moisture and oxidation.

Self-centered . . . Solvent-sealed. Wire wound with Kodapak tape is perfectly centered; thus permits over-all diameters to be held at a minimum. Also, when overcoating of braid is employed, lacquer and lacquer solvents tend to seal tape, forming a continuous waterproof tube around the wire.

Hard to harm it: Because it has excellent strength, stretch, and toughness characteristics, Kodapak Sheet is particularly suitable for use on winding machines. It serves well at high speeds without breaking. These same properties allow wire to be flexed or bent sharply without harming the insulation.



*For further information,
including other applications,
write for free copy of the folder,
"Kodapak Sheet for Electrical Uses."*

Cellulose Products Division, EASTMAN KODAK COMPANY, Rochester 4, N. Y.

Sales Offices:
New York, Chicago.

District Sales Representatives:
Cleveland, Dallas,
Philadelphia,
Providence.

Pacific Coast Distributor:
Wilson & Geo. Meyer & Co., San Francisco,
Los Angeles, Portland, Seattle.

Canadian Distributor:
Paper Sales, Limited,
Toronto, Montreal.

Kodapak Sheet

... for efficient insulation

"Kodapak" is a trade-mark

Kodak

TRADE-MARK

NEW PRODUCTS

Edited by WILLIAM P. O'BRIEN

Radio and TV Equipment Vie With Nuclear Devices . . . Improved Lab Gear and Testing Equipment Are Listed . . . Twenty-Four Literature Items Are Reviewed

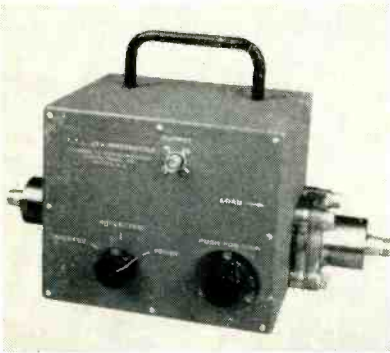

Impedance Measuring Device

FEDERAL TELECOMMUNICATION LABORATORIES, INC., 500 Washington Ave., Nutley 10, N. J. The 42A Impedometer is a compact device for the measurement of impedance in the frequency range from below 50 mc to above 500 mc. Below 500 mc its accuracy is ± 5 percent. It consists of a short length of standard $1\frac{1}{8}$ -in. 52-ohm coax line on which are mounted two directional couplers, a voltage probe and a capacitance plunger. To use the unit a signal generator is connected to one end of the line and the load to be measured is connected to the other end.

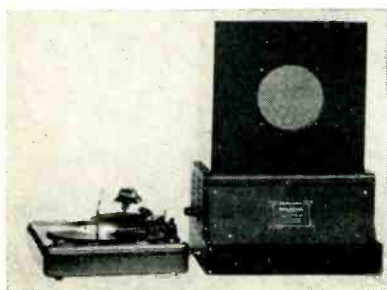

Sound Stretcher

KAY ELECTRIC Co., Maple Ave., Pine Brook, N. J., has announced the Sona-Stretcher, an instrument that lengthens the time scale of recorded sounds by a 2-to-1 ratio but does not alter the frequency

distribution. It covers a sound frequency range of about 100 to 5,000 cycles. The instrument consists of three component parts: a stretching circuit and monitor amplifier; a turntable suitable for standard disc records, with variable reluctance pickup; and a monitor loudspeaker. It is useful in general studies in phonetics and language instruction.

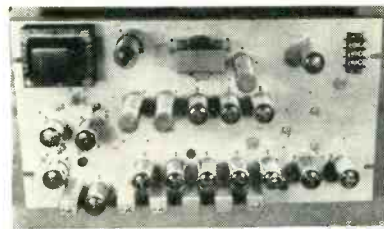

Ultrasonic F-M Receiver

RADIO ENGINEERING LABORATORIES, INC., 36-40 Thirty-Seventh St., Long Island City 1, N. Y. The model 720 Remo receiver is particularly designed for f-m broadcast music in public places, such as restaurants and shopping centers. The audio output can either be muted or boosted by transmission from the broadcast station of a superaudible tone. Specifications are given in Article 10-31.

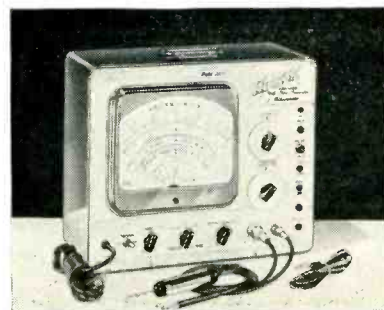

Lab VTVM

THE HICKOK ELECTRICAL INSTRUMENT Co., 10527 Dupont Ave.,

Cleveland 8, Ohio. Model 209-A volt-ohm-capacitance milliammeter is especially designed for increased speed and range for tv engineers and technicians. It measures resistance as low as 0.1 ohm and capacitance of $1 \mu\text{mf}$. The unit has a new a-c range of 1,200 v and features flat frequency response to 300 mc. New literature is available covering full technical details.



Modulation Monitor

RADIO CORP. OF AMERICA, Camden, N. J. Type BW-66E amplitude modulation monitor provides continuous direct reading of modulation percentage in a-m transmitters operating in the 500 to 2,500-kc range. It will measure percentage of modulation on either positive or negative peaks, carrier shift when modulation is applied, and transmitter a-f response. It will also provide overmodulation indication and is useful in program level monitoring. The unit operates from a 75-ohm r-f transmission line, and can accommodate a range of r-f input powers from 0.35 watt to 6 watts. No tuning adjustments are required.

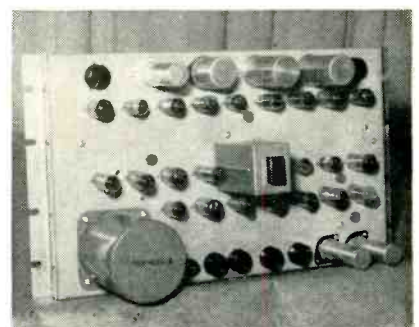

TV Stabilizing Amplifier

GENERAL ELECTRIC Co., Syracuse, N. Y. Type TV-16-B television stabilizing amplifier provides automatic correction of the sync and

ANOTHER *New* RAYTHEON SUBMINIATURE THE CK5829 TWIN DIODE

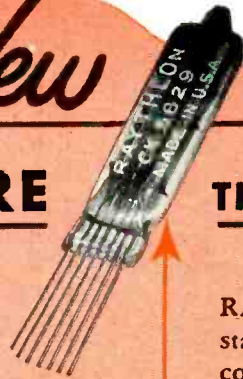

TO PROVIDE YOU WITH

1. High perveance (performance compares favorably with that of the larger 6AL5)
2. Low heater current (150 ma.); half as much as the 6AL5
3. Moderate cost

RAYTHEON *Subminiature Tubes* have long been standard throughout the world. More of them are in commercial use than all other makes combined. They assure *greater product salability* due to size reduction — *greater convenience* because they fit standard sockets or can be soldered or welded into the circuit, and because over half a million are available from stock; over 300 Raytheon Tube Distributors are at your service — *greater dependability*, backed by unsurpassed technical resources and a dozen years of production and application experience with long-life Subminiature Tubes.

— NEW TYPES This chart gives you at a glance the characteristics of representative Raytheon Subminiature Tubes

Type No.	Remarks	Maximum Diameter Inches	Maximum Length Inches	Filament Or Heater		Mutual Conductance umhos	Power Output MW	TYPICAL OPERATING CONDITIONS				Grid Volts	
				Volts	Ma.			Plate Volts	Ma.	Screen Volts	Ma.		
HEATER CATHODE TYPES													
CK626CX	Half Wave Rectifier	0.400	1.75	6.3	300				45				
CK5702/CK605CX	Characteristics of 6AK5	0.400	1.5	6.3	200	5000		120	7.5	120	2.5		Rk=200
CK5703/CK608CX	Triode, UHF Oscillator, ¼ watts at 500 Mc	0.400	1.5	6.3	200	5000		120	9.0				Rk=220
CK5704/CK606BK	Diode, equivalent to one-half 6AL5	0.315	1.5	6.3	130			150ac	9.0				
CK5744/CK619CX	Triode, High mu.	0.400	1.5	6.3	200	4000		250	4.0				Rk=500
CK5784	Characteristics of 6AS6	0.400	1.5	6.3	200	3200		120	5.2	120	3.5		-2.0
CK5829	Similar to 6AL5	0.300x0.400	1.5	6.3	150			117ac	5.0 per section				
FILAMENT TYPES													
1AD4	Shielded RF Pentode	0.300x0.400	1.5	1.25	100	2000		45.0	2.8	45.0	0.8		Rg=2meg
2E31-32	Shielded RF Pentode for pocket radio	0.300x0.400	1.56	1.25	30	500		22.5	0.4	22.5	0.3		0
2E35-36	Output Pentode for pocket radio	0.290x0.390	1.56	1.25	30		6	45.0	0.45	45.0	0.11		-1.25
2E41-42	Diode Pentode for pocket radio	0.290x0.390	1.56	1.25	30	375		22.5	0.35	22.5	0.12		0
2G21-22	Triode Heptode for pocket radio	0.300x0.400	1.56	1.25	50	60		22.5	0.20	22.5	0.30		conv. cond
RK61	Gas Triode, Exp. Radio Control	0.550	1.81	1.4	50			45.0	1.5				Special Circuit
CK510AX	Double Space Charge Tetraode Amplifier	0.285x0.400	1.25	0.625	50		1501 both units	45.0	0.06				0
CK512AX	Low microphonic voltage amplifier	0.285x0.385	1.25	0.625	20	371		22.5	0.125	22.5	0.04		-0.625
CK522AX	Output Pentode 20 ma. filament	0.285x0.385	1.5	1.25	20	450	1.2	22.5	0.30	22.5	0.08		0
CK524AX	Output Pentode	0.285x0.385	1.5	1.25	30	300	2.2	15.0	0.45	15.0	0.125		-1.75
CK525AX	Output Pentode	0.285x0.385	1.5	1.25	20	325	2.2	22.5	0.25	22.5	0.06		-1.2
CK526AX	Output Pentode	0.285x0.385	1.5	1.25	20	400	3.75	22.5	0.45	22.5	0.12		-1.5
CK527AX	Output Pentode 1.5 ma. filament	0.285x0.385	1.5	1.25	15	225	0.75	22.5	0.10	22.5	0.025		0
CK529AX	Shielded Output Pentode	0.290x0.390	1.515	1.25	20	350	1.6	15.0	0.32	15.0	0.075		-1.25
CK533AX	Output Pentode	0.285x0.385	1.5	1.25	15	400	1.8	22.5	0.36	22.5	0.09		0
CK534AX	Voltage Amplifier	0.285x0.385	1.25	0.625	15	301		15.0	0.0047	15.0	0.0014		-0.625
CK535AX	Output Pentode	0.285x0.385	1.5	1.25	20	350	1.6	15.0	0.32	15.0	0.075		-1.25
CK551AXA	Diode Pentode	0.300x0.400	1.56	1.25	30	235		22.5	0.17	22.5	0.043		0
CK553AXA	RF Pentode	0.300x0.400	1.56	1.25	50	550		22.5	0.42	22.5	0.13		0
CK571AX	10 ma. filament Electrometer Tube, I _g = 2x10 ⁻¹¹ amps. max.	0.285x0.400	1.5	1.25	10	1.61		10.5	0.20				Triode Conn. -3.0
CK573AX	Triode, High-Freq. Osc.	0.300x0.400	1.5	1.25	200	2000		90.0	11.0				-4.0
CK574AX	Shielded Pentode RF Amplifier	0.290x0.390	1.25	0.625	20	160		22.5	0.125	22.5	0.04		-0.625
CK5672	Output Pentode	0.285x0.385	1.5	1.25	50	650	65.0	67.5	3.25	67.5	1.1		-6.5
CK5676/CK556AX	Triode, UHF Oscillator	0.300x0.400	1.5	1.25	120	1600		135.0	4.0				-5.0
CK5677/CK568AX	Triode, UHF Oscillator	0.300x0.400	1.5	1.25	60	650		135.0	1.9				-6.0
CK5678/CK569AX	Shielded RF Pentode	0.300x0.400	1.515	1.25	50	1100		67.5	1.8	67.5	0.48		0
CK5697/CK570AX	Electrometer Triode Max. grid current 5x10 ⁻¹¹ amps.	0.285x0.400	1.25	0.625	20	1.51		12.0	0.22				-3.0
CK5785	High voltage rectifier	0.300x0.400	1.5	1.25	15				0.1				Inverse peak 3500 volts
CK5851	Class C. RF Beam Tetraode	0.400	1.6	1.25	110	1600		125	5.5	125	1.0		-7.5
CK5889	7.5 ma. filament electrometer pentode I _g = 3x10 ⁻¹¹ amps. max.	0.285x0.385	1.6	1.25	7.5	14		12.0	0.005	4.5	0.005		-2.0
VOLTAGE REGULATORS													
CK5783	Voltage reference tube—like 651	0.400	1.625					Operating voltage 87.		Operating current range 1.5 to 3.5 ma.			
CK5787	Voltage regulator	0.400	2.06					Operating voltage 100.		Operating current range 5 to 25 ma.			
CK	®	RK	®										†Voltage Gain Ratio.



RAYTHEON MANUFACTURING COMPANY

SPECIAL TUBE SECTION • Newton 58, Massachusetts

Excellence in Electronics

SUBMINIATURE TUBES • GERMANIUM DIODES and TRIODES • RADIATION COUNTER TUBES • RUGGED, LONG LIFE TUBES

blanking portion of a tv signal. It features adjustable sync percentage, can remove noise and hum from the video signal will combine sync and video or separate sync and video, and automatically clips black and white spikes. The unit can increase the picture signal by up to 20 db.

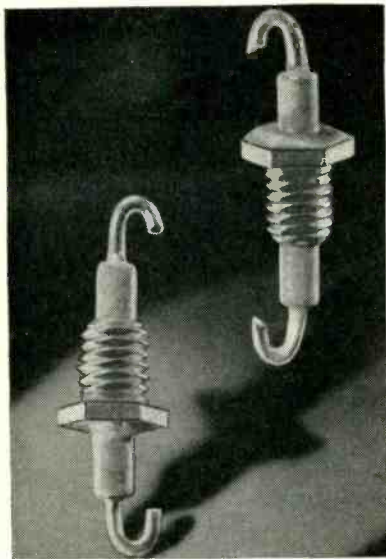

Feed-Through Capacitors

CENTRALAB, 900 E. Keefe Ave., Milwaukee 1, Wisc., now offers tiny ceramic feed-through capacitors designed for single-hole mounting where a capacitance ground to either chassis or shield is desired. They are available in 500, 1,000 and 1,500 μmf . Voltage rating is 600 volts d-c working, 1,000 volts d-c flash test. Both ends of the terminals are hooked to facilitate soldering.

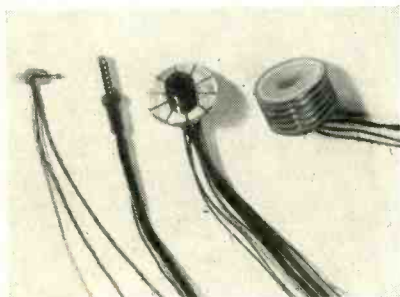

Miniature Plated Commutators

THE ELECTRO-TEC CORP., 53 Bergen Turnpike, Little Ferry, N. J., has pioneered the use of precious metal

electroplating for fabrication of all size commutators and slipping assemblies. The miniature sections illustrated are firmly anchored to withstand high centrifugal force at up to 12,000 rpm. Commutator forms are stamped out of laminated linen base bakelite sheets with the laminations running parallel to the segment faces in order to utilize the strength of the linen base. By threading wire connections prior to plating, the wires and segments are bonded so as to be impervious to heat.

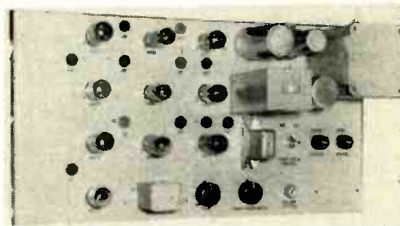

Sync Lock Unit

GENERAL ELECTRIC Co., Syracuse, N. Y. Type TV-30-A television sync lock unit allows remote picture signals to be treated and handled like local studio productions. Through its use local commercials, special effects or other local program material can be inserted into the remote picture without disturbance. This is accomplished by means of automatic synchronization of the local sync generator with the remote sync signals.



TV Sweep Generator

KAY ELECTRIC Co., Maple Ave., Pine Brook, N. J., has announced the Switcha-Sweep, an all-electronic tv sweep generator with fundamental outputs on all channels as well as output in the i-f range. A rotary switch selects the desired channel, which is swept through a

range of 15 mc. Sawtooth sweep eliminates phasing problems. Amplitude modulation of the sweep signal is less than 1 percent per megacycle. Both switched and continuously variable output attenuation is provided, with maximum outputs of about 0.5 volt on the 70-ohm unbalanced output and 1 volt on the 300-ohm balanced output.



Voltage-Regulated Power Supply

KEPCO LABORATORIES, INC., 149-14 41st Ave., Flushing, N. Y. Model 315 features one regulated B supply, one regulated C supply and one unregulated filament supply. The B supply is continuously variable from 0 to 300 v and delivers from 0 to 150 ma. The C supply is continuously variable from 0 to 150 v and delivers 5 ma. Ripple is less than 5 mv. The a-c output is 6.3 v, 5 amperes, center-tapped, unregulated.



Ore Detector Kit

ALLIED RADIO CORP., 833 W. Jackson Blvd., Chicago, Ill. The Scout radio-active ore detector, in addition to field survey work, may be used for

(continued on p 242)

Power for RF Heating...



RCA-5770
150 kw input
to 20 Mc.



RCA-5786
1.5 kw input
to 160 Mc.



RCA-5762
5.5 kw input
to 110 Mc.



RCA-5771
60 kw input
to 25 Mc.



RCA-5671
80 kw input
to 25 Mc.



RCA-5831
650 kw input

THE FOUNTAINHEAD OF MODERN TUBE DEVELOPMENT IS RCA

...with the economy of thoriated-tungsten filaments

THESE SIX improved RCA power tubes are "musts" for designers of industrial electronic heating equipment where design and operating economies alike are important considerations.

Ranging in power input from 1.5 to 650 kw, these types successfully utilize thoriated-tungsten filaments which offer marked savings in filament power and the cost of associated power equipment.

The 5671 utilizes an effective lightweight radiator while the 5762 and 5786 have radiators designed to permit use of less-expensive blowers than have been required previously for similar tubes. The new and revolutionary RCA-5831 super-power beam triode with internal water cooling, is tested at one million watts input, and handles with high efficiency an input of 650 kilowatts in continuous commercial service.

Air jackets for the 5671 and 5762, and water jackets for the 5770 and 5771, are available from RCA.

RCA Application Engineers are ready to consult with you on the application of these improved tubes and accessories to your specific designs. For complete technical information covering the types in which you are interested, write RCA, Commercial Engineering, Section J42R, Harrison, N. J.



RADIO CORPORATION of AMERICA
ELECTRON TUBES
HARRISON, N. J.

NEWS OF THE INDUSTRY

Edited by WILLIAM P. O'BRIEN

AIEE-IRE Electronic Instrumentation Conference

FINAL DATES for the third annual joint AIEE-IRE Conference on Electronic Instrumentation in Nucleonics and Medicine have been set as October 23, 24, and 25, 1950. Location of this meeting which will feature technical papers and discussions on the various problems in instrumentation for the vital fields of nuclear and medical science, is the Park Sheraton Hotel, New York City.

More than 300 persons attended the highly successful three-day gathering last year at which papers were presented covering the non-nucleonic phases of electronics in medicine, nucleonics in medicine, and nucleonic developments in industry and government.

Such great interest was evoked in the papers presented that they were compiled and published in the form of a consolidated pamphlet covering the proceedings of the conference and made available by the

two organizations. This year's meeting will be held along the same lines and a similar type of publication is contemplated.

Prominent among the features of the conference is a special evening meeting during which a number of prominent authorities will discuss, "Effects of Atomic Weapons"—a government publication containing recently declassified information on the subject. They will explain various parts of the book in an effort to educate the technical man in the techniques of protection from atomic weapons so that he in turn can pass on the information.

Interesting and informative exhibits of instruments and related products will be displayed by leading companies in the field. Those attending the meeting will have an opportunity to see many of the devices (some in actual operation) that will be discussed in the technical papers.

Ford's Rouge Railroad Gets Radio System

INSTALLATION of a two-way radiotelephone communication system for direction of railroad traffic over the 105 miles of track in Ford Motor Co.'s Rouge plant will be completed within a year. The Rouge railroad,

largest such industrial system in the world, is one of the first private lines to adopt this method for traffic direction. As of August, the special equipment had been installed in ten of the company's 19

diesel-electric locomotives.

Ford officials expect the radio control system to improve the railroad's overall efficiency, expedite the movement of freight cars in and out of the yards, and speed execution of all switching orders. It is the result of four years of experimentation with equipment and methods by the company's communications, railroad and plant security sections. A special control tower has been constructed to serve as the brain center for the system.

Audio Fair Program

THE THIRD ANNUAL AUDIO FAIR, sponsored by the Audio Engineering Society will be held from Oct. 26 to 28, 1950, at the Hotel Commodore, N. Y. The advance program of papers for the technical sessions is as follows:

Thurs. Oct. 26

Symposium on High Fidelity Audio Systems For the Home, by N. C. Pickering of Pickering & Co., R. H. Synder of Station KJBS, San Francisco, and M. S. Corrington of RCA.

Proposed Standard Method of Calibrating Cutters & Pickups, by H. E. Roys of RCA.

RMA Standards Covering Loudspeaker Systems and Associated Equipment, by O. L. Angevine of Stromberg-Carlson Co.

Educational Audio Requirements, by W. J. Temple.

Application of Square Wave Testing to Disc Recording (speaker to be announced) of Naval Research Lab., Washington, D. C.

Fri. Oct. 27

New Developments in Radio Tubes and Their Application to Audio Circuits, (speaker to be announced).

A Consideration of Intensity-Loudness Function and Its Bearing Upon the Judgment of Tonal Range and Volume Level, by S. E. Stuntz of U. S. Naval Medical Research Lab, New London, Conn.

CBS Television Studio Intercommunication Facilities, by R. B. Monroe of CBS-TV.

Report of the A.E.S. Standards Committee on Playback Characteristic (speaker to be announced).

Free Field Audiometry, by R. Allison of



Dispatcher (right) at the mike of Ford railroad's new radiotelephone communication system relays switching orders to diesel locomotives in the 105-mile track yard. The traffic direction unit is located in a 42-foot high control tower (left)

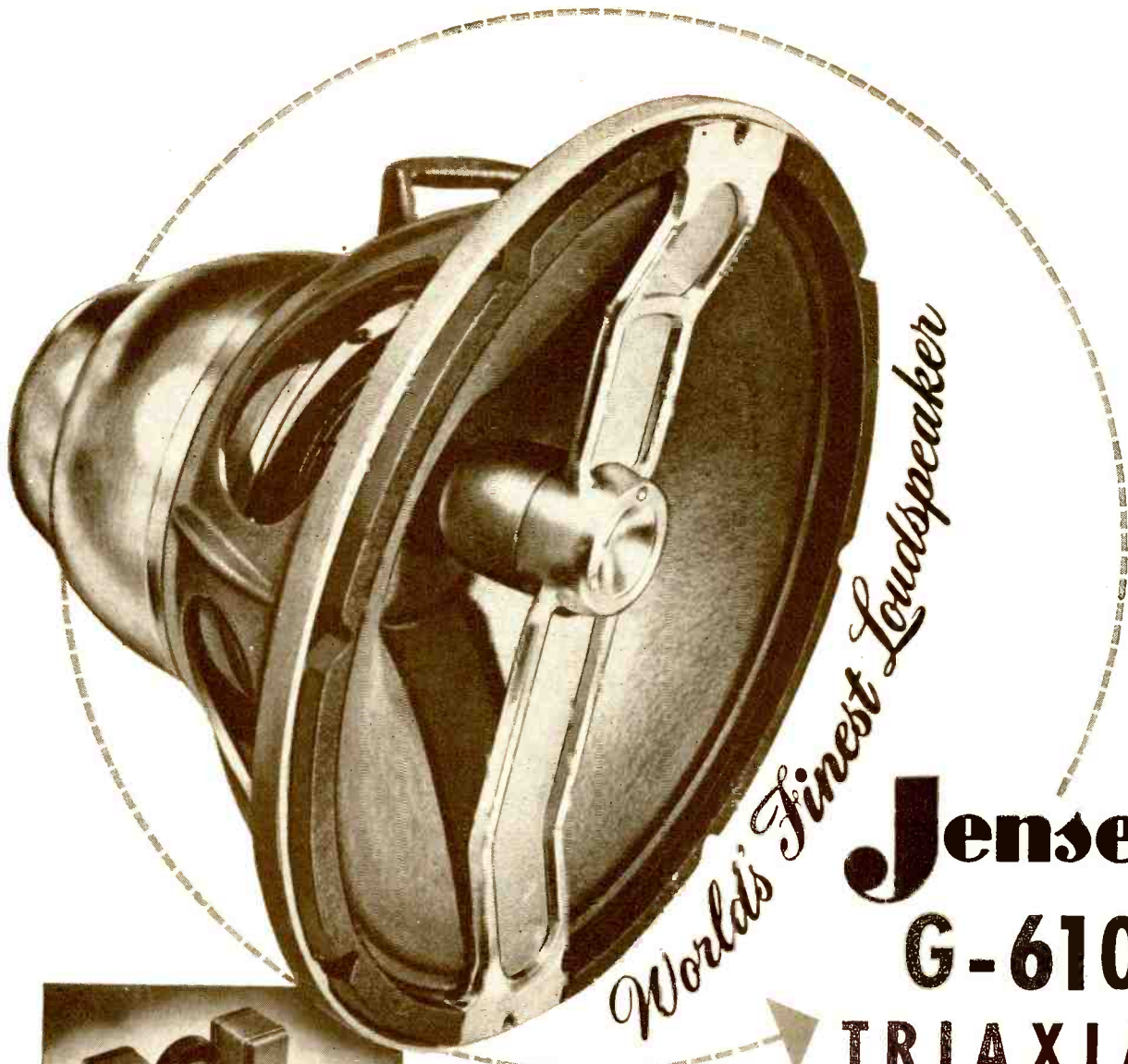

World's Finest Loudspeaker

Jensen

G-610

TRIAxIAL

LOUDSPEAKER SYSTEM

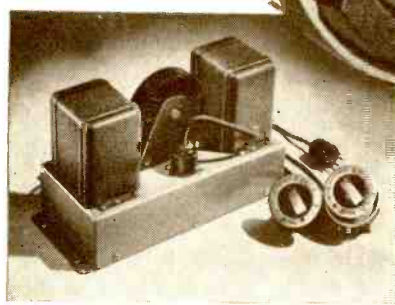

Never Before Reproduction Like This!

The G-610 brings a totally new meaning to high fidelity sound reproduction. Not only does this new 3-channel system reproduce the widest frequency range ever attained by a loudspeaker, but it also sets new high standards with its incomparably smooth response characteristic and very low distortion. The result is clear, clean, life-like quality, with thrilling *transport to the original* such as you have never heard before. The G-610, complete with Speaker Unit and Crossover and Control network is priced at \$365.00 list. Ask for Data Sheet 160.

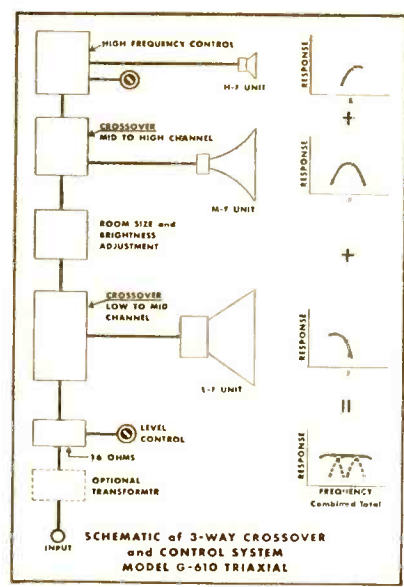

Jensen

Manufacturing Company

Division of the Muter Company

6607 SOUTH LARAMIE AVENUE, CHICAGO 38, ILLINOIS

Microtone Co., St. Paul, Minn.
 The Measurement of Audio Volume, by
 H. A. Chinn of CBS.
 A New Low Cost Intermodulation Meas-
 urement and Analysis Technique, by C. J.
 Lebel, audio consultant.
 Loudspeaker Damping, by A. Preisman
 of Capitol Radio Engineering Institute.

Sat. Oct. 28

Multi-Channel Magnetic Tape Record-
 ing, by P. Brubaker of Rangertone, Inc.
 A Solution to Magnetic Tape Timing
 Problems, by D. R. Andrews of RCA.
 Action of A-C Bias in Magnetic Tape
 Recording, by W. W. Wetzel of Min-
 nesota Mining & Mfg. Co.
 Sprocket Hole Magnetic Tape Record-
 ing, by A. C. Davis of Cinema Engineer-
 ing Co.

IRE Emporium Seminar

A NUMBER of prominent speakers were featured at the eleventh annual seminar of the Emporium Section of the Institute of Radio Engineers, held August 18 and 19 at Emporium, Pa.

Included as speakers for the technical sessions were Norman Pickering of the Pickering Co., Oceanside, N. Y., who discussed high-quality audio reproduction; C. Wesley Carnahan of the Sandia Corporation, Albuquerque, N. M., who spoke on the application of electronics to remote control devices; R. M. Bowie of Sylvania Electric Products Inc., Bayside, N. Y., who reported on color television; and F. M. Geyer of the Corning Glass Works, who discussed the electrical characteristics of glass.

ARINC Expands Pacific Communication Services

NEW equipment installed in Hawaii by the Mackay Radio and Telegraph Co., subsidiary of the American Cable and Radio System, will permit coverage of the entire Pacific area with both radiotelephone and radiotelegraph service to aircraft and base stations, thereby expediting the increased flow of air traffic to the Far East.

This rapid expansion in available communication services in this area has been carried out under the direction of Aeronautical Radio, Inc., or ARINC as it is commonly known, the organization established and supported by the air industry to operate radio communication stations wherever required.

Mackay, under terms of a contract with ARINC, broke ground for a large extension to its radio transmitter at Kailua, Hawaii, on June 21, and before the deadline

MEETINGS

SEPT. 25-27: National Electronics Conference, Edgewater Beach Hotel, Chicago, Ill.

SEPT. 30-OCT. 8: Third Annual National Television & Electrical Living Show, Chicago Coliseum, Chicago, Ill.

OCT. 3-5: AIEE District No. 2 Meeting, Lord Baltimore Hotel, Baltimore, Md.

OCT. 16-20: 68th Semiannual Convention of SMPTE, Lake Placid Club, Lake Placid, N. Y.

OCT. 23-25: Third Annual Joint AIEE-IRE Conference on Electronic Instrumentation in Nucleonics and Medicine, Park

Sheraton Hotel, New York City.

OCT. 23-27: AIEE Fall General Meeting, Skirvin Hotel, Oklahoma City, Okla.

OCT. 26-28: Second Audio Fair, sponsored by the Audio Engineering Society, Hotel New Yorker, New York City.

OCT. 30-Nov. 1: Radio Fall Meeting, sponsored jointly by IRE and RTMA engineering department, Hotel Syracuse, Syracuse, N. Y.

MAR. 19-22: IRE Annual Convention, Hotel Waldorf Astoria and Grand Central Palace, New York City.

date of August 1 had completed the installation of four multichannel transmitters and associated antennas. The new equipment was manufactured by Federal Telephone and Radio Corp., a subsidiary of the International Telephone and Telegraph Corp.

N. Y. Ferries Get Radar

ALL City of New York ferries operating between Manhattan and Staten Island will be radar-equipped by the end of the year. Contracts for double-ended installations of X-band General Electric radar navigators in the eight ferries now on the run have been received by the Marine Electric Corp. of Brooklyn, N. Y., distributors for G-E equipment.

Each craft will have two radar consoles, with a scope in each pilot house. Skippers of the ferries will receive training in the use of radar during their two-week installation layups.

Disaster Communications

PROPOSED rules for providing emergency radio communications have been formulated by the FCC. They provide for "disasters and other incidents involving loss of communications facilities normally available or demanding the temporary establishment of communications facilities beyond those normally available".

The Disaster Communications Service would operate in the frequency band of 1,750-1,800 kilo-

cycles. Any fixed, land or mobile station could qualify for participation in such emergency operation, including amateurs and commercial radio operators.

It is proposed that application for authorization to operate in the Disaster Communications Service for a radio station already licensed in a different service shall be submitted directly to the Commission. The application would detail the individual's eligibility and include a certified copy of the locally coordinated disaster communication plan.

In this proposal it is mandatory that a local network be set up under appropriate leadership with rules for self-government and operating procedure that will tend to assure an orderly and reasonably efficient service.

Radio Fall Meeting

LATEST technical developments of radio and television equipment and components will be discussed at the annual Radio Fall Meeting sponsored by the IRE and RTMA engineering department, to be held at the Hotel Syracuse, Syracuse, N. Y., Oct. 30 to Nov. 1. Following is the tentative technical program:

Mon. Oct. 30

9:30 A.M.—General Session (Ralph R. Batcher, presiding)

A Broad Range Oscillator for Television Testing, by H. A. Finke and J. Ebert of Polytechnic Research and Development Corp.

Wideband Impedance Matching Between a Resonant Antenna and a Line, by H. A. Wheeler of Wheeler Laboratories, Inc.

High Frequency Crystal Calibrator Design, by J. B. Minter of Measurements Corp.

The Determination of Amplifier Sensi-
 (Continued on page 282)

These Leaders look to SYLVANIA for dependable TV Picture Tubes

Admiral

air^oking

Arvin

*Bendix
Television*

Colbest

CONRAC

CROSLEY

DEWALD

**Emerson
Television**

FADA

hallicrafters

Hoffman

INDUSTRIAL
TELEVISION INC

Kaye-Halbert

Magnavox

Meck



Motorola

national

Olympic

Packard Bell

Phaostron

PHILCO

PILOT

SCOTT

Sentinel

Silvertone

Sparton

Starrett

**STROMBERG-
CARLSON**

SYLVANIA

Tele King

Tele tone

TRAV-LER

Westinghouse

• The trade-marks shown here identify the television leaders now choosing and using Sylvania TV Picture Tubes in their sets.

The reasons behind today's acceptance of Sylvania tubes include greater clarity, consistent color, dependability, and longer life.

Remember, your dealers as well as set owners recognize Sylvania as a symbol of distinction—a name associated with the very finest in radio and television.

For full descriptions and ratings of all Sylvania TV Picture Tubes, write today to Sylvania Electric Products Inc., Dept. R-2110, Emporium, Pa.



SYLVANIA ELECTRIC

RADIO TUBES; TELEVISION PICTURE TUBES; ELECTRONIC PRODUCTS, ELECTRONIC TEST EQUIPMENT; FLUORESCENT TUBES, FIXTURES, SIGN TUBING, WIRING DEVICES; LIGHT BULBS; PHOTOLAMPS; TELEVISION SETS

NEW BOOKS

The Principles of Television Reception

By A. W. KEEN. *Sir Isaac Pitman and Sons, Ltd., London, 1949, 319 pages, 30 shillings.*

THIS short book, by a well-known contributor to the British technical press, is unusual in that it treats the American and British television systems on an equal footing, and is one of the few sources of comparative data on receiver design in the two countries. Complete circuit diagrams of popular American and British receivers of the 1947 vintage are included.

The book opens with chapters on system standards, basic video signal theory and circuit operation. The following six chapters are devoted to detailed examination of typical receiver circuit functions. Chapters on aerial systems and test equipment are included. The final

chapter gives an introduction to color television, describing the wideband field-sequential and simultaneous systems. Since the manuscript was prepared in 1947, no mention is made of the line-sequential or dot-sequential systems.

The treatment is non-mathematical in the text proper, but a

mathematical appendix is included for those who wish to consult it. The book is not intended for design engineers, except as it reveals details of receiver practice (many of which are now unfortunately out-moded, such is the pace of tv design in both countries). The book is an excellent introduction to the subject, however, and is recommended to all who wish to compare British and American methods.—D. G. F.

Ralph 124C 41 +

By HUGO GERNSBACK. *Second Edition, 1950, Frederick Fell, Inc., New York, 207 pages, \$2.50.*

SHADES of Edward Bellamy, Jules Verne and all the more recent imaginative writers of science fiction! This book is a revival of one of the early classics of that peculiar brand of literature that is at once the dismay of those who don't like it and the bread and life of those who do. And to anyone in this field of electronics who has followed Hugo Gernsback through the years,

(Continued on p 133)

RELEASED THIS MONTH

Better Television Reception; W. Smith and R. L. Dawley; Editors and Engineers Ltd.; \$2.50.

Father of Radio—The Autobiography of Lee de Forest; Wilcox & Follett Co.; \$5.00.

Response of Physical Systems; John D. Trimmer; Wiley; \$5.00.

The Effects of Atomic Weapons; McGraw-Hill; \$3.00.

TV Installation Techniques; Samuel L. Marshall; Rider; \$3.60.

BACKTALK

This Department is Operated as an Open Forum Where Readers May Discuss Problems of the Electronics Industry or Comment Upon Articles that ELECTRONICS has Published

Why not here?

DEAR SIRs:

I READ with much interest the paper by Dr. Brueckmann which appeared in the May 1950 issue of ELECTRONICS on an antenna for the regular broadcast band used on the broadcast station in Frankfort designed to push out the rapid fading zone and increase efficiency.

My special interest is due to the fact that in the late thirties, I spent some time on the theory of such an antenna and variations of it and also on an antenna fed at more than one point, whereby the current distribution along the antenna could be controlled accurately, so as to provide the desired radiation dis-

tribution in the vertical plane. On the basis of this work I applied for patents and was in due course granted patents No. 2,283,617, No. 2,283,618, No. 2,283,619. I had thought that the clear channel stations in the United States would have been interested to have had their service improved by such antennas, but no interest has been shown by them. I was therefore very interested to find that German broadcast stations have found this antenna worth while. Dr. Brueckmann has just written me that he believes another German station, located at Muhlacker, has a similar antenna under construction.

RAYMOND M. WILMOTTE, INC.
Consulting Engineers
Washington, D. C.

ELECTRONICS Quiz

AS PROMISED in July *Crosstalk*, here is the first installment of our electronics puzzle-quiz column. To start, we will publish one problem every month and its solution the following month, along with the next problem. Readers are encouraged to submit brain-teaser problems for this department. A payment of \$5.00 will be made for each acceptable entry.

This month's problem is submitted by R. W. Johnson, China Lake, California.

What is the power dissipated by the plate resistor of a class A audio amplifier when both a sinusoidal and d-c component of plate current are present?

Answer will appear next month.

Neutralizing Bifilar I-F Stages

DEAR SIRs:

IN THE PAPER "Bifilar I-F Coils", appearing in the June 1950 issue of ELECTRONICS, it is stated that a

(Continued on p 290)

Just Published!

HIGH-SPEED COMPUTING DEVICES

1. A fundamental book that gives you a clear picture of the various mathematical methods and physical mechanisms, including electrical circuits, developed for use in automatic computation. Acquaints you with the general character of computing machines and outlines arithmetic techniques used in their operation. Points out varied uses for large-scale machines; explains importance and nature of the relationship between a machine and its operator, and between machine capabilities and the required mathematical tools. Aids executives, mathematicians, and computers in deciding which computing system is most readily applicable to a given problem. Describes types of systems, physical components, methods, desk calculators, large-scale systems, data-conversion equipment, etc. **By the staff of Engineering Research Associates, Inc., Edited by W. W. Stifter, Jr.** 440 pages, 90 illus. \$6.50



STRUCTURAL PLASTICS

2. A compilation of selected information on the nature, properties, and utilization of structural plastics. Gives chemists, structural engineers, architects, aircraft designers, etc. practical know-how and theory on material fabrication and applications. Shows how to develop, design, and apply plastics for efficient structural use. Summarizes structural plastic research. Includes charts, graphs, and easy-to-consult data. **By H. C. Engel, Consultant; C. B. Hemming, U. S. Plywood Co., and H. R. Merriman, Glenn Martin Co.** 301 pgs. 96 illus. \$4.50

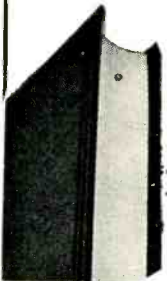

RADIO ENGINEERING HANDBOOK

3. Brings you 1197 pages of design data, charts, tables, circuits, diagrams, and formulas; an invaluable aid in solving radio engineering problems quickly, easily, and accurately. Gives designers, engineers, and radio technicians principles, standards, and procedures to get quick answers to routine and special assignments in communications, broadcasting, aircraft radio, television, etc. Fully revised for greater usefulness. New subjects include cavity magnetrons, radar and loran, sequential scanning, crystal converters, TV allocation, disk seal tubes, lobe switching. **Edited by Keith Henney, 4th Ed.** 1197 pgs. \$10.00

Examine one or all 10 days FREE

McGraw-Hill Book Co.
330 W. 42nd St., N.Y.C. 18, N. Y.

Send me book(s) corresponding to numbers encircled below for 10 days' examination on approval. In 10 days I will remit for book(s) I keep, plus few cents for delivery, and return unwanted book(s) postpaid. (We pay for delivery if you remit with this coupon; same return privilege.)

1 2 3

Name.....
Address.....
City..... Zone..... State.....
Company.....
Position..... L-10-50

This offer applies to U. S. only

NEW BOOKS

(continued)

who has read his stuff and wondered just how crazy he might be, this book is must reading.

For Gernsback, to those youngsters who have the misfortune to have been born recently (say since 1920) and who therefore know only modern electronics, was the publisher of a periodical called Modern Electrics back in 1908 and thereabouts, a paper which still lives gloriously in the memories of all old-timers in radio.

In 1911, when Modern Electrics had a circulation of about 100,000, the editor and publisher wound himself up into some sort of electronic stew and concocted a serial with the above title. He kept up this atrocious bit of fiction for a year, and in it he predicted a lot of things now only recently come to pass.

In 1925, our Ralph became a book, famous among the science fiction writers. Early in 1950 second-hand book stores wanted \$50.00 for a copy of this first edition and there were few to sell.

With forewords by Lee deForest and Fletcher Pratt, this little book is fascinating reading and surely will prove to lots of us that its author is not as crazy as we thought.—K. H.

Electrical Communication

By ARTHUR LEMUEL ALBERT, Professor of Communication Engineering, Oregon State College. John Wiley & Sons, Inc., New York. Third Edition, 1950, 593 pages, \$6.50.

THIS new edition of Professor Albert's useful text follows the general scheme of earlier editions—to provide a concise picture of all aspects of modern communication systems as means for transmitting and receiving intelligence in the form of codes or voice or music over radio or wireless circuits.

In the first part of the new edition the author has grouped certain basic subject matter useful to any communication system; that is, acoustics and electroacoustic devices, lines, filters, cables and waveguides. Thereafter he deals with specific mechanisms.

There are chapters on telegraph

HOW modern electronic devices work in industry today

WHAT the different types of vacuum tubes can do in specific installations.

SURVEY OF MODERN ELECTRONICS

By PAUL G. ANDRES
Illinois Institute of Technology

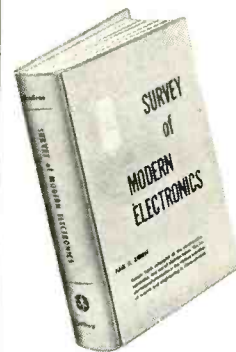

GIVES TESTED MATERIAL USED BY MANY MANUFACTURERS

Most books on electronics describe equipment used or produced by two or three companies. *Survey of Modern*

Electronics gives you data and circuits used by nearly every manufacturer in the field. Based on the author's 18 years of engineering experience and 10 years of technological teaching, this new book employs industry technique and design to relate fundamental knowledge with technical details.

The main emphasis is placed on practical application. The book examines the basic principles of electronic tubes and explains their use in such devices as the automatic pilot and electronic measuring equipment. It covers tube applications such as are found in the proximity fuse, electronic electrocardiograph, radar, induction and dielectric heating . . . instrumentation, communication and control.

A generous number of illustrations—many supplied by manufacturers—help make this up-to-date survey accurate and complete. To examine this time-saving book without obligation, mail the coupon today.

Sept., 1950 522 pages 380 illus. \$5.75

APPROVAL COUPON

JOHN WILEY & Sons, Inc., Dept E-950
440 Fourth Ave., New York 16, N. Y.

Please send me, on 10 days' approval, a copy of Andres' Survey of Modern Electronics. If I decide to keep the book I will remit \$5.75 plus postage; otherwise I will return the book postpaid.

Name.....
Address.....
City..... Zone..... State.....
Employed by.....
(Offer not valid outside U. S.)

TEFLON



HIGH HEAT-RESISTANT
COAXIAL CABLES made with

TEFLON CABLES

AN NUMBER	AMPHENOL NO.	IMPEDANCE IN OHMS	OD OF ARMOR	JACKET DIAMETER	TYPE JACKET	SHIELDS 1st 2nd	OD OF DIEL.	INNER CONDUCTOR	V.P.	CAP. MMFD/FT.
RG-87A/U	21-250	50		.425	FSI	S S	.280	7/205	69.5%	29
RG-116/U	21-378	50	.475	.425	FSI	S S	.280	7/205	69.5%	29
RG-117/U	21-377	50		.730	FSI	C	.620	.188	69.5%	29
RG-118/U	21-374	50	.780	.730	FSI	C	.620	.188	69.5%	29
RG-119/U	21-398	50		.465	FSI	C C	.328	10 bare	69.5%	29
RG-120/U	21-399	50	.515	.465	FSI	C C	.328	10 bare	69.5%	29
Similar to RG-58/U	21-382	50		.191	FSI	S	.116	19S	69.5%	29
Similar to RG-59/U	21-379	73		.221	FSI	S	.146	21S	69.5%	21
Similar to RG-11/U	21-391	72		.365	FSI	S	.280	7/23S	69.5%	21
Similar to RG-55/U	21-385	50		.216	FSI	S S	.116	19S	69.5%	29
Similar to RG-5/U	21-388	50		.265	FSI	S	.185	15S	69.5%	29

FSI—Fiberglass Silicone Impregnated

C—Copper

S—Silver-Coated Copper

Amphenol Now Produces Teflon
in Eleven sizes

Electronics Engineers will want to keep this listing at hand for quick reference. If you do not wish to remove this chart from this publication, AMPHENOL will gladly send a reprint of the advertisement.

AMERICAN PHENOLIC CORPORATION, 1830 SOUTH 54TH AVENUE • CHICAGO 50, ILLINOIS

NEW BOOKS

(continued)

systems, telephone exchange service and systems, telephone toll service and systems, radio wave propagation, antennas, radio systems and a final useful chapter on interference and noise.

When one considers that there are many thousands of radio engineers who have only the remotest idea of how to hook up a telephone and who might sometime wish to do so without calling upon AT&T, it is clear that a book of this type is not only useful as a text but as a reference book. This is indeed the fact; and this reviewer, a radio man, enjoyed finding out what happens when you lift the hook on the telephone, or how a teletypewriter works, or what the Varioplex system is, or the basic facts concerning the numerous carrier telephone systems now in use.

Some of the early history of the communication art is most interesting and since it is not allowed to occupy much space in this book, it is distinctly worthwhile.—K. H.

Photoelectric Cells in Industry

By R. C. WALKER. Pitman Publishing Corp., New York, 1948, 510 pages, \$8.50.

THE OBJECT of this British book is best described by the author's words, "... to present a representative selection of the industrial uses of light-sensitive cells of the emission and rectifier types, with a very superficial explanation of the theory of operation of these devices, sufficient, it is hoped, to make the text readable to practical men whose purpose is to employ electrons rather than theorize about their internal affairs." This modest though somewhat verbose statement (as are most of the sentences in the book) pretty well tells the story.

It is difficult to imagine a capable industrial electronics engineer who could not benefit from this book. One scan through its pages, just looking at illustrations, should bring to mind some possible idea for putting photosensitive devices to work. The final solution may or may not come from the same pages, but adequate information is supplied for design and construc-

For low-level d-c measurements Use these new, triple-purpose D-C INDICATING AMPLIFIERS



stabilized for zero and gain

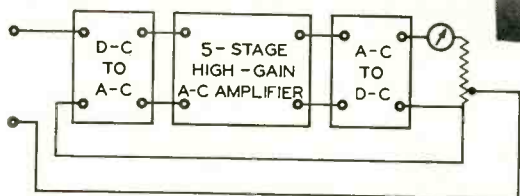

Voltage-balance feedback (above) and current-balance feedback stabilize gain . . . provide virtual null balance.

USE AS

- DIRECT-READING MICROVOLT METER OR MICRO-MICROAMMETER
- RECORDER PREAMPLIFIER
- NULL DETECTOR

SPECIFICATIONS

MICROVOLT UNIT

Catalog No. 9835

FULL SCALE RANGES WITH BUILT-IN 4" METERS
0 to 50 or —25 to +25 Microvolts; scale multipliers: 1, 2, 4, 10, 20, 40

MICRO-MICRO-AMPERE UNIT

Catalog No. 9836

0 to 1000 or —500 to +500 Micro-Micro-amps; scale multipliers: 1, 2, 5, 10, 20, 50, 100, 200, 500, 1000, 2000

ACCURACY

Of amplifier: $\pm 0.4\%$
of reading ± 0.5 Microvolt; Of meter: $\pm 1\%$

Of amplifier: ± 0.5 to 0.8% * of reading
 ± 20 Micro-Micro-amps; Of meter: $\pm 1\%$

STABILITY

Zero and Gain stabilized automatically. No trimmer controls required.

*SOURCE RESISTANCE

Up to 10,000 ohms. | 0.1 megohm or more.

RESPONSE TIME

2 to 3* sec. | 2 to 3* sec.

OUTPUT

For full scale input on any range: 10 millivolts at output impedance of 500 ohms for null recorder; 1 volt for 20,000-ohm external meter.

Front panel fits standard 19" relay rack.

*Accuracy and Response Time depend on Source Resistance.

These new instruments are not only D-C Indicating Amplifiers but are stable, accurate measuring instruments as well. You can use them in measurements with thermocouples, strain gages, bolometers . . . bridge and potentiometer circuits . . . ionization, leakage, and phototube currents . . . almost any measurement of extremely small direct current or voltage.

Through a combination of a-c amplification and unique balanced feedback network, zero and gain stability are designed right into the instrument. Trimmer controls are designed out—eliminated.

Actually *three* instruments in one, these amplifiers can be used as—

Direct-reading instruments . . . At the turn of a scale-multiplier knob, you simply select the range in which you want to work.

Recorder preamplifiers . . . with broad flexibility. For instance, one or two degrees of temperature difference can be spread across an entire Speedomax recorder scale.

Null detectors . . . more sensitive than most reflecting galvanometers, yet with full scale response time of only 2 to 3 seconds. Leveling is unnecessary. There's no worry about shock or vibration. At the turn of a range knob, you have available a wide choice of sensitivities. External shunts are not required. And when using non-linear response, not only does the instrument stay on scale at extreme unbalance; sensitivity increases automatically as the null point is approached. For details, write to Leeds & Northrup Co., 4979 Stenton Ave., Phila. 44, Pa.

Jrl ad EM9-51(1)

MEASURING INSTRUMENTS · TELEMETERS · AUTOMATIC CONTROLS · HEAT-TREATING FURNACES
LEEDS & NORTHRUP CO.

FOR TV RECEIVER TESTING ★ FOR BROADCAST

Get both VHF and



Electronic

Fast and Reliable TV Receiver Testing—makes this scope particularly useful in head-end position work. Unsurpassed for stability and fine trace . . . excellent definition . . . no bounce when shifting bands. Where the sweep generator does not have a baseline, measurements can be taken on the DC amplifier. Delivers maximum sensitivity without sacrifice of frequency response. Low capacity input probe is provided for trouble shooting.

In Broadcast Stations, It Pin-points Trouble—helps you stay on the air with maximum performance. Use it to check hum, noise, distortion, modulation, phase relationships; measure gain and sweep generator output; isolate defective components; determine frequency response of audio circuits.

In Laboratories, It's Versatile—Fits many applications where waveform study is essential. Built-in voltage calibrator permits calibration of the scope for voltage measurements. Gives you wide frequency response without recourse to peaked amplifier coupling circuits. Straight resistance coupling is used, and the scope can be employed on frequencies up to 3 mc. Excellent transient response within the frequency range of the instrument.

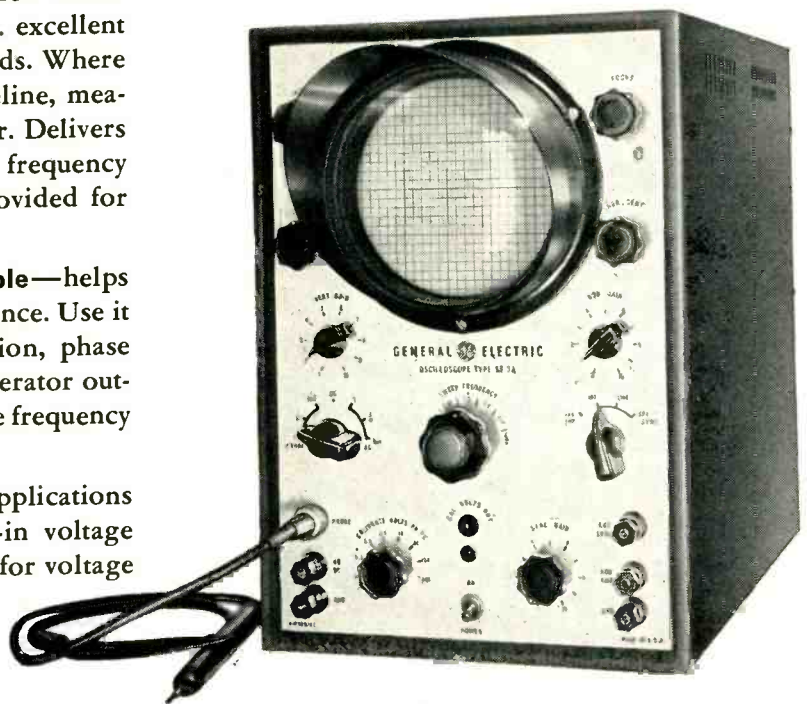

TV SCOPE ST-2A

SPECIFICATIONS

Frequency Response

Vertical Amplifier

Probe and AC—+0,—20% from 20 cycles to 500 kc (Square Wave response 60 to 40,000 cycles.)

+0,—50% from 20 cycles to 1 megacycle with gradual reduction in response beyond 1 mc.

DC—+0,—20% from 0 to 500 kc at full gain setting.

Sweep Range

10 cycles to 100 kc in six overlapping ranges.

Sensitivity

Vertical

1. AC Input—.015 volts RMS per inch
2. DC Input—2.0 volts DC per inch
3. Probe—.20 volts RMS per inch

Horizontal—.4 RMS volts per inch

Calibrating Voltages

Seven AC voltages of power line frequency—.3, 1.5, 3, 15, 30, 150 and 300 volts with $\pm 15\%$ accuracy.

STATIONS ★ FOR DEVELOPMENT LABORATORIES

UHF coverage

TEST EQUIPMENT

VARIABLE PERMEABILITY SWEEP GENERATOR—ST-4A

Completely Electronic. No Moving Parts. Using an exceptionally wide linear sweep, this instrument is ideal for television receiver maintenance, TV production and development laboratories, wide band amplifier study, and transmission line impedance measurements. The front panel is slotted, permitting the equipment to be removed and mounted in a standard 19-inch relay rack. A new Balanced Output Adaptor (Type ST-8A), also available, provides balanced 300 ohm output from the sweep generator.

SPECIFICATIONS

Frequency Range: Continuously variable from 4 to 110 mc and 170 to 220 mc. Can be used through 900 mc on harmonic operation.

Sweep Width: Linear from 500 kc to greater than 15 mc.

Output Voltage: Greater than 0.1 volts from 4 to 110 mc.
Greater than 0.5 volts from 170 to 220 mc.

Output: Single-ended or balanced 300 ohm output.

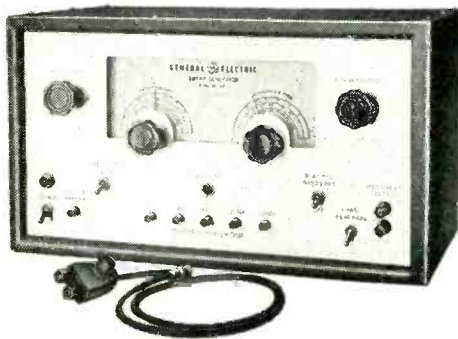

MARKER GENERATOR TYPE ST-5A

Functions as a crystal referenced calibrator from 10 mc to 300 mc. When used with the G-E sweep generator, it provides a multiple of markers spaced 1.5 or 4.5 mc apart . . . or can be used to supply a marker or markers at any frequency from 10 mc to 900 mc.

SPECIFICATIONS

Picture Carrier Oscillator: 15 position rotary selector switch selects 12 crystal-controlled frequencies plus 3 tuneable ranges covering intermediate frequencies.

Channel Crystal Accuracy: .02%

IF Ranges: 3 Bands—20 to 27 mc; 27 to 37 mc; 37 to 50 mc
Accuracy: dial hand calibrated, crystal calibrator $\pm .05\%$.

Crystal Modulator: Provides audio and intermediate frequency locations simultaneously with picture carrier.

Crystal Accuracy: 4.5 mcs .05%. 1.5 mcs .15%.

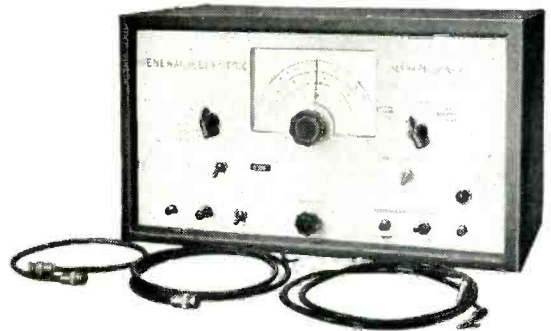

ILLUSTRATED BULLETINS

Complete information will be furnished on any of the General Electric test instruments listed here. Check those you are interested in . . . then fill in and mail the coupon today.

- | | |
|--|--|
| <input type="checkbox"/> TV Scope ST-2A | <input type="checkbox"/> Industrial Tube Analyzer YTW-3 |
| <input type="checkbox"/> Sweep Generator ST-4A | <input type="checkbox"/> Distortion and Noise Analyzer YDA-1 |
| <input type="checkbox"/> Marker Generator ST-5A | <input type="checkbox"/> Square Wave Generator |
| <input type="checkbox"/> Balanced Output Adaptor ST-8A | <input type="checkbox"/> Industrial Scope YNA-4 |
| <input type="checkbox"/> Regulated Power Supply YPD-2 | |

General Electric Company, Section 4100
Electronics Park, Syracuse, New York

Please send me further information on products checked at left.

NAME.....

COMPANY.....

ADDRESS.....

CITY.....STATE.....

GENERAL  ELECTRIC

tion of even the most elaborate installations.

Many of the techniques discussed are recognized as having been in existence for quite some time. However, their value is not lessened by their age in this case.

One possible shortcoming of the book is the lack of down-to-earth what-tube-do-I-use and what-value-of-resistor information that is so important to many engineers and technicians. Both British and American light-sensitive devices are discussed.—J. F.

Better Television Reception

By WOODROW SMITH AND R. L. DAWLEY. Editors and Engineers Ltd., Santa Barbara, Calif., 141 pages paper-covered, \$2.50.

SPECIFIC recommendations are given for the best method, the best antenna and the best accessories for improving vhf television reception in fringe and low-signal locations. Techniques presented apply to difficult nearby locations behind hills or in canyons, as well as locations far beyond line-of-sight paths from transmitters. Emphasis is on practical rule-of-thumb data, with theory included only to give a general idea of the considerations involved.

Of particular interest technically is the second chapter, dealing with propagation phenomena. Subjects covered here include bending or diffraction of tv signals, picking up of ground reflection after diffraction, explanation of focusing by diffraction to give a strong-signal region directly behind a large rounded-top hill, focusing by reflection where a hill of gradually increasing slope approaches a section of a parabola, utilizing focused ground reflections and reflections from large objects, elimination of ghosts, use of ghosts, analysis of conditions leading to fading and flutter, intelligent use of boosters, and realignment of video i-f amplifiers in receivers for reception of very weak signals.

Other chapters, equally detailed, cover receiving antennas, transmission lines, mast installation and interference problems. Examples of practical data are the recom-

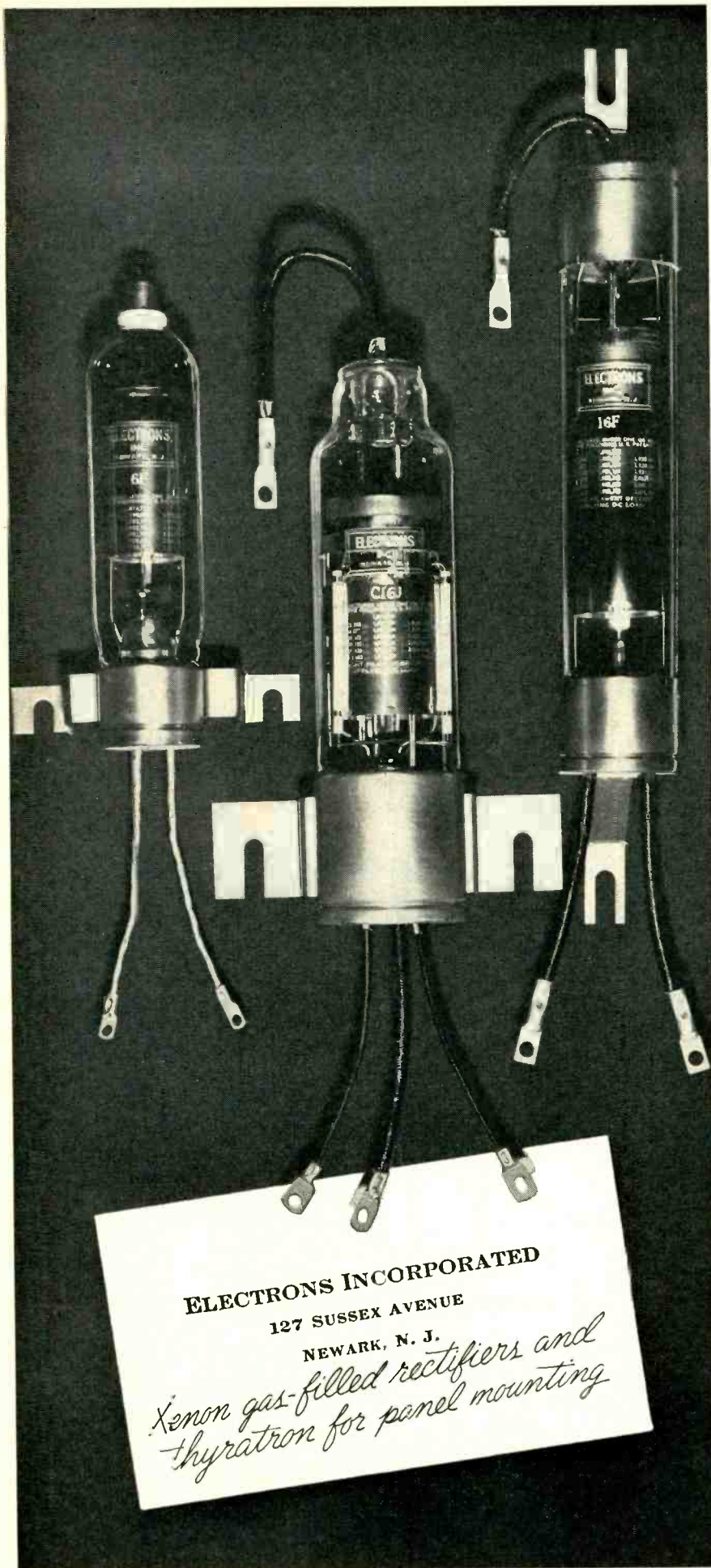

they

may

look

alike,

but:

there

is

only

one

C-D

RELIABILITY

Businessmen call it *reputation* . . . accountants refer to it as *goodwill* . . . production men think of it as *reliability*. Reliability has a dollar-and-cents value entirely apart from the quality and price of the capacitors you buy.

That is why so many leading radio equipment manufacturers insist on C-D capacitors. They know that C-D's extensive manufacturing facilities, reliable service, dependable quality are features that cannot be measured in dollars and cents. Typical of this C-D reliability is the:



"Blue Beaver"™* Electrolytic

- Special formation process—developed by C-D engineers after years of research — insures low leakage; good performance at high temperatures; long life at high voltages.
- Low contact resistance between anode and lead wires and negative lead to can, by unique assembly procedure. Contact resistance checked on kelvin bridges and maintained at low value.
- Special separator material prevents breakdowns under most adverse conditions.
- A positive acting diaphragm vent — developed in C-D labs — insures proper venting when needed.
- Special insulator around positive lead eliminates shorts to can.
- Extreme care in assembly to eliminate all contamination plus the finest raw materials obtainable insure a unit free from corrosion.

For details on these and other C-D electrolytics write for catalog. CORNELL-DUBILIER ELECTRIC CORPORATION, Dept. K10, South Plainfield, New Jersey. Other plants in New Bedford, Brookline and Worcester, Mass.; Providence, R. I.; Indianapolis, Ind., and subsidiary, The Radiart Corp., Cleveland, Ohio.

C-D Best by Field Test!

CONSISTENTLY DEPENDABLE

CORNELL-DUBILIER

CAPACITORS • VIBRATORS • ANTENNAS • CONVERTERS



1910 1950



NEW Miniature Telephone Type Relay

NEW LK RELAY

MOUNTING: End mounting for back of panel or under-chassis wiring. Interchangeable with standard "Strowger" type mounting.

COIL POWER: From 40 milliwatts to 7 watts D.C.

CONTACTS: Standard 2 amperes, special up to 5 amperes. 2 amperes up to 6 P.D.T. 5 ampere contacts (low voltage) up to 4 P.D.T. Special 20 ampere power contacts S.P.S.T., normally open, paralleled.

DIMENSIONS:

1⁵/₈" HIGH, 2⁷/₃₂" LONG,
1³/₃₂" WIDE

*These are the dimensions
for the 6 pole relay.*

*Will meet Army and Navy
aircraft specifications
as a component unit.*

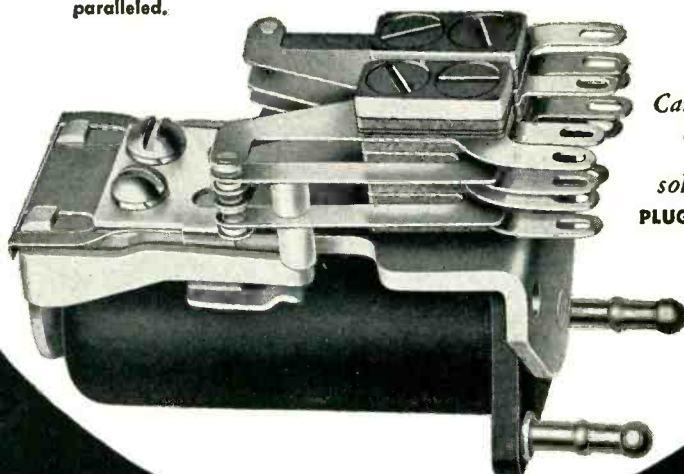

*Can be furnished
hermetically
sealed with
solder terminals.*
**PLUG-IN MOUNTING-
SPECIAL.**

SK RELAY

MOUNTING: Front of panel mounting and wiring.

COIL POWER: From 100 milliwatts to 4.5 watts D.C.

CONTACTS: Same as "LK".

DIMENSIONS: 1¹/₂" HIGH, 1⁷/₁₆" LONG, 3¹/₃₂" WIDE.

*These are the dimensions
for the 4 pole relay.*

*Will meet Army and Navy
aircraft specifications
as a component unit.*

**CAN ALSO BE FURNISHED
HERMETICALLY SEALED
WITH SOLDER TERMINALS.
PLUG-IN — SPECIAL.**

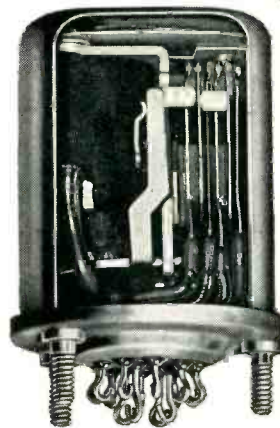
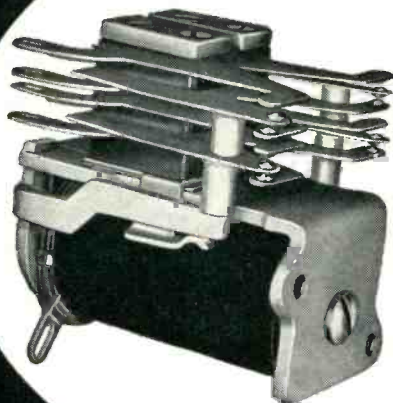

SK, HERMETICALLY SEALED

AL-132



ALLIED CONTROL CO. INC. 2 EAST END AVE., NEW YORK 21, N. Y.

4 Truarc Rings save \$2.41 unit cost, Simplify Design, Assembly, Maintenance

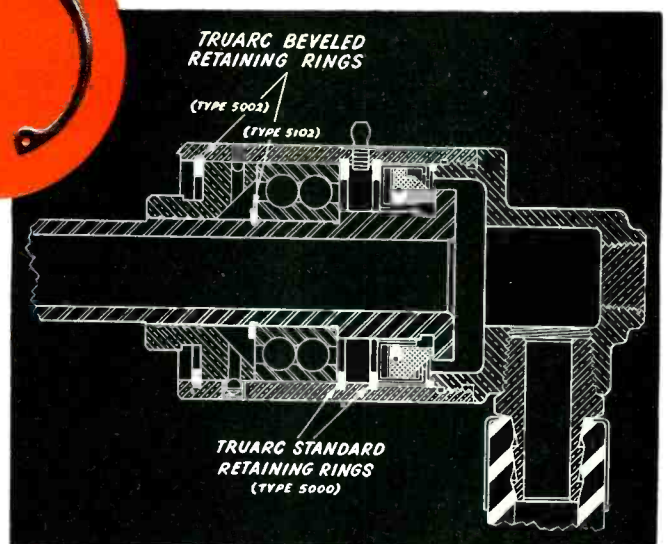
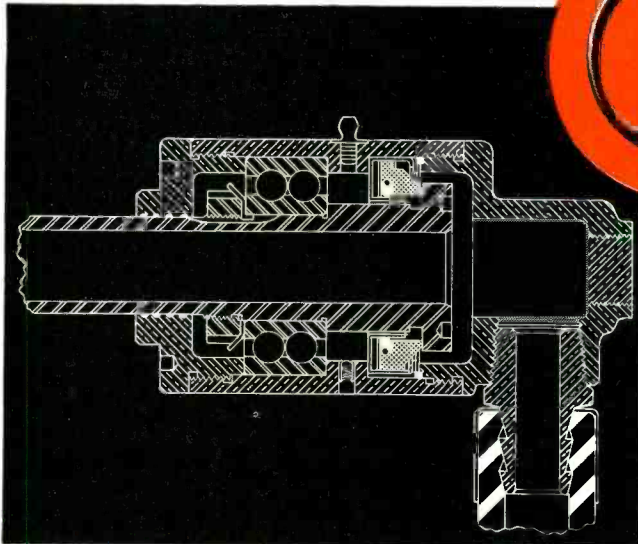
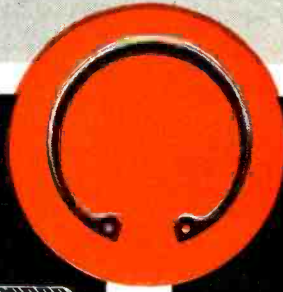

Conventional Way. This design died on the drawing boards, because the Deublin Company, Northbrook, Ill., found the simplified design, using Truarc Rings, superior and more economical.

Truarc Way. Truarc Beveled Retaining Ring holds cap in place, takes up end play, locks entire assembly. Second Beveled Ring positions ball bearing on rotor. 2 standard Truarc Rings position bearing and removable seal, eliminate shoulders, permit manufacture of housing from strong, non-porous, easily machined brass tubing. Unit can be serviced in minutes simply by removing 2 Truarc Rings.

HOW \$2.41 WAS SAVED

Materials saved

decreased wall thickness of housing	\$.79
eliminated bearing lock nut and washer18
	<u>.97</u>

Machine operations eliminated

Bore, undercut, and tap cap end of housing39
Locate cap on arbor, and chase threads28
Drill spanner wrench holes10
Cut thread on rotor for lock nut09
Mill slot in thread for tang on lock washer18
Drill spanner wrench holes in rotor10
	<u>1.14</u>

Assembly operations eliminated

Install lock washer, tighten lock nut, bend lug20
Assemble cap into housing10
	<u>.30</u>

TOTAL SAVINGS \$2.41

THE Deublin Union—a rotating joint for steam, air, or water—is simple, rugged, easy to service. 4 Waldes Truarc Rings hold entire unit together, permit simplified design, cut unit cost \$2.41.

Improve and simplify your own product design with Truarc Rings, and you too will cut costs. Wherever you use machined shoulders, nuts, bolts, snap rings, cotter pins, there's a Waldes Truarc Ring that does a better job of holding parts together.

Truarc Rings are precision engineered. Quick and easy to assemble, disassemble. Always circular to give a never-failing grip. They can be used over and over again.

Find out what Truarc Rings can do for you. Send your blueprints to Waldes Truarc engineers for individual attention, without obligation.

SEND FOR NEW CATALOG →

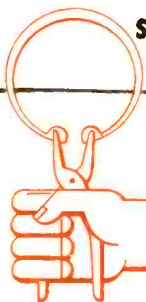

WALDES TRUARC

REG. U. S. PAT. OFF.

RETAINING RINGS

WALDES KOHINOOR, INC., LONG ISLAND CITY 1, NEW YORK

WALDES TRUARC RETAINING RINGS ARE PROTECTED BY THE FOLLOWING PATENT NUMBERS:
U. S. PATENTS 2,382,948; 2,420,921; 2,411,761; 2,487,803; 2,487,802; 2,491,306 AND OTHER PATENTS PENDING

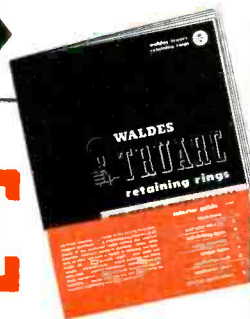

Waldes Kohinoor, Inc., 47-16 Austel Place
Long Island City 1, N. Y.

E102

Please send the new catalog on
Waldes Truarc Retaining Rings.

Name _____

Title _____

Company _____

Business Address _____

City _____ Zone _____ State _____

4KW

**KEEPS
ITS FOOT
DOWN ON
INDUCTANCE
AND CAPACITANCE**

because the opposed windings are on a special flatted core

It's a Ward Leonard exclusive—a non-inductive resistor with Ayrton-Perry winding around a core that's *flatted* on opposite sides. Purpose of the flats? To make sure the crossings of the two windings are exactly 180° apart—thus reducing inductance and distributed capacitance to an absolute minimum.

For high watt rating in a given size unit . . . low difference in potential between adjacent turns . . . absence of undesirable high capacitance—specify Ward Leonard non-inductive resistors.

Write for Resistor Catalog. Ward Leonard Electric Company, 31 South Street, Mount Vernon, N. Y. Offices in principal cities of U. S. and Canada.

**WARD LEONARD
ELECTRIC COMPANY**

Result-**E**ngineered Controls

RESISTORS • RHEOSTATS • RELAYS • CONTROL DEVICES



mentations that tubular 300-ohm line be sealed at the top but left open at the bottom to permit breathing, and that elaborate and costly antenna installations be protected against rust and corrosion with a coating such as Krylon plastic spray. Zinc-coated marine hardware is preferable for long-time weather resistance. Screw eyes for guy wires should be used only with a sidewise pull, as screw threads alone should not be relied on to take the pull.

Though intended primarily for the professional television antenna installer and the amateur experimenter, this book is also highly recommended for the engineer who wants to install or experiment with his own television antenna system in a fringe-area location.—J. M.

The Radio Manual

BY GEORGE E. STERLING AND ROBERT B. MONROE, *D. Van Nostrand Co., New York, 1950, Fourth edition, 890 pages, \$12.00.*

IT IS SAFE TO SAY that this volume represents a comprehensive study of the entire field of radio communication. The field is broad and its subdivisions are diversified, but the authors seem to have had the skill, experience and initiative to weigh each phase and to collect and record a good balance of general information.

This fourth edition is a completely rewritten and reworked version of its already famous predecessors. Entirely new chapters have been added on such subjects as f-m systems, propagation, antennas and emergency equipment, and there is an especially comprehensive chapter on television. The other chapters have been revised to include the latest developments in studio and transmitter techniques. The last three chapters list the latest regulations governing radio and allied arts.

In dealing with a subject, pieces of actual equipment are discussed. Complete circuits of typical transmitters are explained in detail. Mobile and marine installations are thoroughly treated. Also included are chapters on up-to-date direction-finding and test equipment.

This book is not a radio engi-

YOU CAN BE **SURE**.. IF IT'S
Westinghouse



Transformer Insulation Problem Licked!

Here's how one perplexing problem was solved . . . a typical example of the modern engineering available at Westinghouse for all types of transformer applications.

The application: Electronic transformers on a rectifier power supply circuit with high frequency and operating voltages up to 2,465 volts. Small size and light weight were essential. Terminals required: seventeen! The transformers originally used in this application couldn't "stand the gaff" . . . the high voltages caused coil deterioration because of corona in a matter of hours.

The Westinghouse solution: A practical design, now proved by hundreds of hours of successful operation, with indication of indefinite life.

To accomplish the objective, spacings inside the transformer were increased, but over-all dimensions held, by shrinking the size of the core. Westinghouse HIPERSIL® cores, having 25% more flux-carrying capacity, made this possible. Better clearances and better radii on leads were obtained by relocating the terminal board. Complete impregnation with FOSTERITE® provided the superior insulating qualities desired.

J-70564

If you have a tough transformer problem, take advantage of the facilities of Westinghouse for quick, practical solutions. Transformers specially designed for all types of electrical and electronic circuits, as well as a wide selection of standardized designs . . . produced in quantity . . . with quality. Call your nearby Westinghouse representative, or write Westinghouse Electric Corporation, P. O. Box 868, Pittsburgh 30, Pennsylvania.



Westinghouse

SPECIALTY

TRANSFORMERS

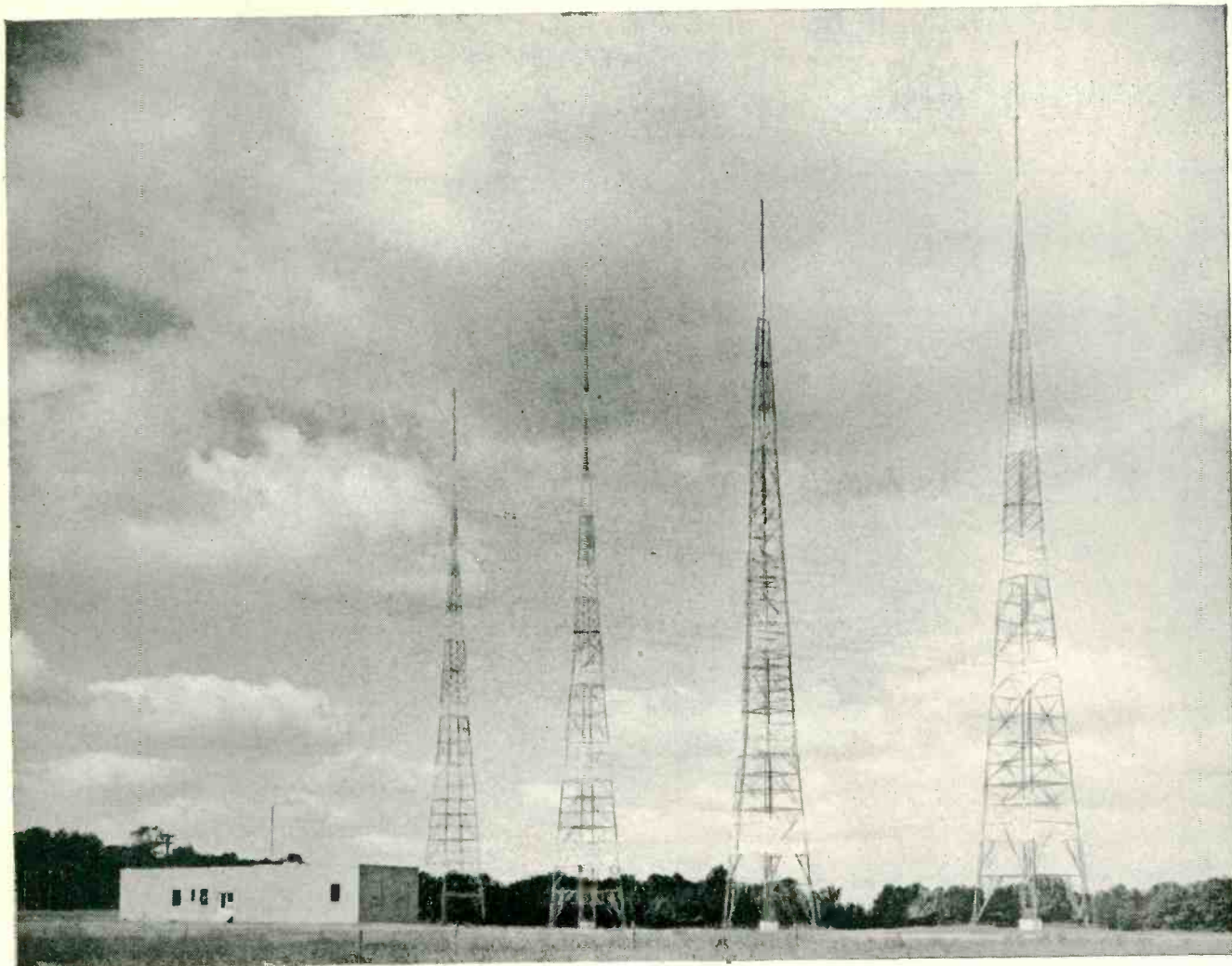

**IT'S
ALL
THERE!**

You can't see Blaw-Knox engineering—but *it's there!* You can't see Blaw-Knox experience in tower-building—but *it's there.* You can't see efficiency and strength and durability—but they're all there—when the towers are built by Blaw-Knox.

... A quotation will prove that there's no premium on Blaw-Knox quality.

BLAW-KNOX DIVISION
OF BLAW-KNOX COMPANY
2077 Farmers Bank Building, Pittsburgh, Pa.

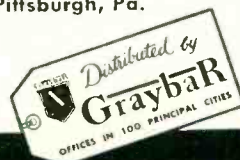

BLAW-KNOX ANTENNA TOWERS



Design-Unlimited

WITH CORNING METALLIZED GLASS INDUCTANCES



About the only limiting factor in Corning Metallized Glass Inductances is that they cannot be easily duplicated to operate much below 30 Megacycles.

Aside from that, just give us your specifications and Corning engineers will quickly design and send you samples. Once approved, they can be easily duplicated to surprisingly close tolerances on a production basis.

When special tuning characteristics or convenient terminating areas in inductances with fine turns are desired, variable pitch coils are easily supplied. Double pitch windings are available for r.f. transformer or inductive coupling purposes. The conductor width may even be modified to give you distributed parameters. Gaps between turns can vary from

as little as .020" to as much as one-eighth of an inch.

Fixed tuned, permeability tuned, or permeability tuned inductance-trimmer combinations can be supplied with appropriate powdered iron cores and convenient mounting bushings. Assembly can be made by conventional methods.

Corning Inductances offer many special advantages. High temperature stability due to low expansion coefficient of the glass coil form, and the low temperature coefficient of the dielectric, results in negligible drift characteristics. Minimum allowable Q is 150. The smooth glass form assures noiseless tuning. Rugged and durable, they can stand repeated handling. Assembly costs are lower. Whatever your inductance requirements, Corning engineers can help you. Write for further information today.

CORNING GLASS WORKS

ELECTRONIC SALES DEPARTMENT



CORNING, N. Y.

Corning means research in Glass

METALLIZED GLASSWARE: INDUCTANCES · CAPACITORS · BUSHINGS · ALSO A COMPLETE LINE OF TELEVISION TUBE BLANKS

Really Smooth—Outstandingly Quiet—Fully Dependable

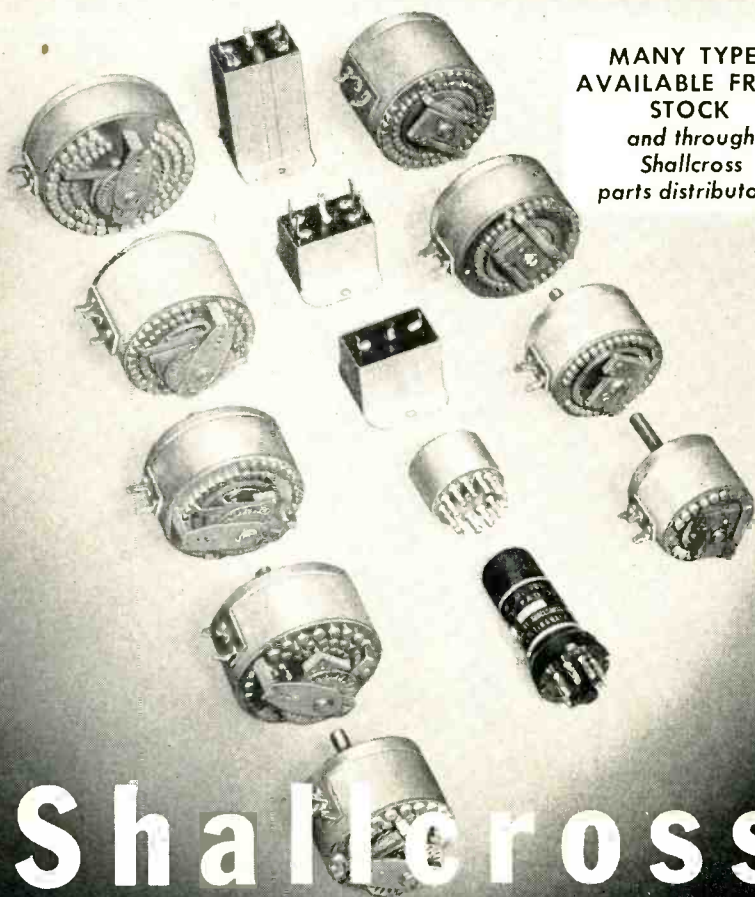

**MANY TYPES
AVAILABLE FROM
STOCK
and through
Shallcross
parts distributors**

Shallcross *Precision* **ATTENUATORS**

ALL STANDARD FIXED AND
VARIABLE TYPES

•
LADDER AND BALANCED
LADDER CONTROLS

•
"T" CONTROLS

•
BALANCED "H" CONTROLS

•
POTENTIOMETERS

•
VARIABLE IMPEDANCE
MATCHING NETWORKS

•
V. U. METER RANGE
EXTENDING ATTENUATORS

•
STANDARD AND SPECIAL
FIXED PADS

•
SPECIAL NETWORKS

RESISTORS — INSTRUMENTS — SWITCHES — ATTENUATORS

Perhaps you've noticed how frequently Shallcross attenuators now appear in the finest audio or communications equipment? Or how often they are chosen for replacement purposes?

There's a reason! Improved design, materials and production techniques have resulted in a line that sets new, higher standards of attenuation performance for practically every audio and communications use.

Shallcross Attenuation Engineering Bulletin 4 gladly sent on request.

Shallcross Manufacturing Co.
Dept. E-100 Collingdale, Pa.

NEW BOOKS

(continued)

neering education in itself. It is not the kind of book one reads cover to cover (890 large-size pages with over 800 illustrations). However, it fills the bill as a ready reference for the engineer and/or operator who needs a quick answer to routine or special questions and problems.—J. F.

THUMBNAIL REVIEWS

TELEVISION FOR RADIOMEN. By Edward M. Noll. The MacMillan Co., New York, 595 pages, \$7.00. Principles of television receiver circuits, with emphasis on servicing aspects, for nonengineering readers.

TRIPLE PINDEX. Available from RCA distributors, 75 cents. Compilation of base diagrams of over 600 tube types, arranged as three identical booklets joined in single spiral-binding cover so up to three desired diagrams may be seen and studied simultaneously.

HIGH POWER PULSE TRANSFORMER DESIGN AND DEVELOPMENT. Section of report by Armour Research Foundation for Bureau of Ships. 229 pages, \$8 in microfilm or \$28.75 in photostat, from Library of Congress, Photoduplication Service, Publication Board Project, Washington 25, D. C. Intended to minimize use of skilled highly-trained design talent. Gives theory of pulse transformers, details of Armour interleaved winding design that places primary and secondary conductors in a single layer, and steps in electrical and mechanical design procedure for development to meet specific requirements.

PRINCIPLES OF COLOR SENSITOMETRY. Society of Motion Picture and Television Engineers, 342 Madison Ave., New York 17, N. Y., 72 pages, \$1.00. Basic text dealing with instruments available for color research and quality control in connection with commercial color processes. Contains sections on Sensitometric Exposures, The Processing of Sensitometric Tests, Quantitative Evaluation of the Image, Densitometer Design Principles, Transformations Between Integral and Analytical Densities, Interpretation of Sensitometric Results, Statistical Aspects of Color Sensitometry, and References.

THE SPECIAL THEORY OF RELATIVITY. By Herbert Dingle. Methuen's Monographs on Physical Subjects (British), published in U.S.A. by John Wiley & Sons, Inc., New York, 1950, 94 pages, \$1.25. Third edition of monograph first published in 1940, based on short course of lectures given to students at Imperial College. Treatment involves development of whole form of the theory from a re-definition, along ordinary scientific lines, of the measurement of length.

WAVE GUIDES. By H. R. L. Lamont. Methuen's Monographs on Physical Subjects (British), published in U.S.A. by John Wiley & Sons, Inc., New York, 1950, 118 pages, \$1.50. Third edition of monograph first published in 1942, with a number of new sections, a new chapter and a bibliography brought up to date. Covers theory, attenuation and stability of waves, wave guides as resonators and radiators, and rectangular guide techniques.

RESISTANCE WELDING—DESIGNING, TOOLING, AND APPLICATIONS. By Wallace A. Stanley. Progressive Welder Co., Detroit. McGraw-Hill Book Co., New York, 1950, 329 pages, \$7.50. Background or basic information on resistance welding, characteristics of standard equipment, design considerations for products to be assembled by resistance spot, projection, seam or flash butt welding, evaluation of weld quality, practical data on getting the most out of resistance-welding equipment, and time-saving techniques. Highly practical book for engineers as well as production men, of real value to electronic engineers who work with welders even though by intent the author has ignored the subject of electronic welding controls.

Inside Information on the Inside of a Tube

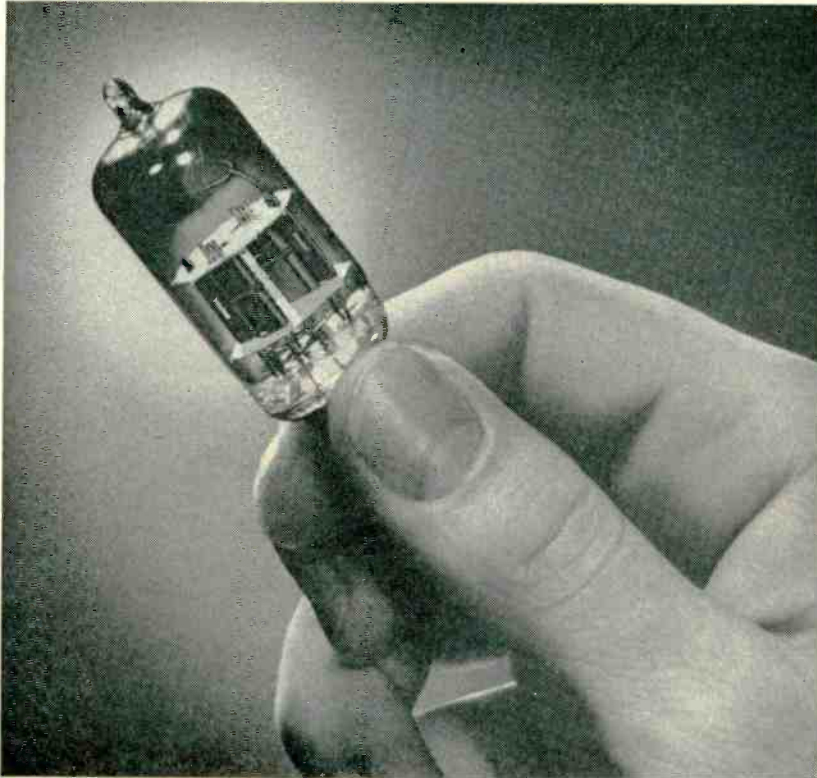

● The public-at-large does not know, as you do, that within nearly every electronic or television tube are other tubes. Or that these other tubes—of metal—can be as troublesome as they are tiny.

To see that they behave properly, the Electronics Division of Superior maintains excellent tubing research facilities, exercises tight control over production and product, helps you think your way out of problems in design and specification.

Superior was one of the early birds in electronics tubing—is always one of the first to come to your aid when you have tubing trouble... and is definitely a leader in tubing technology.

If you are one of the few electronic tube manufacturers who are not now enjoying all the help Superior can give you, get in touch with us today. Superior Tube Company, 2500 Germantown Avenue, Norristown, Pennsylvania.

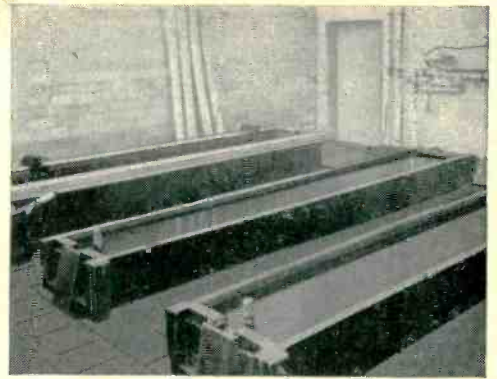

Acid House Equipment where material is cleaned and rinsed before bright annealing.

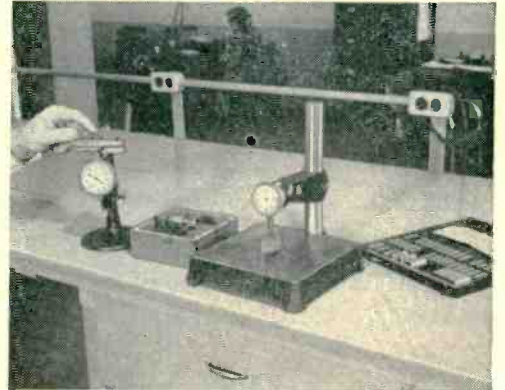

Inspection and Gaging... equipment for checking dimensions of Seamless and Lockseam Cathodes.

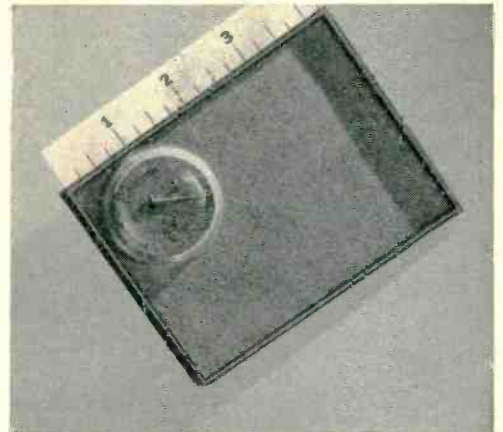

52,600 Seamless Nickel Cathodes... standing on end compared with a ruler, and an ordinary pin under a lens.

Which Is The Better For Your Product . . .

SEAMLESS...? The finest tubes that can be made. Standard production is .010" to .121" O.D. inclusive, with wall thicknesses of .0015" to .005". Cathodes with larger diameters and heavier walls will be produced to customer specification.

Or LOCKSEAM* . . . ? Produced directly from thin nickel alloy strip stock, .040" to .100" O.D. in standard length range of 11.5 mm to 42 mm. Round, rectangular or oval, cut to specified lengths, beaded or plain.

*MFG. UNDER U. S. PATS. SUPERIOR TUBE COMPANY

Electronic Products for export through Driver-Harris Company, Harrison, New Jersey * Harrison 6-4800

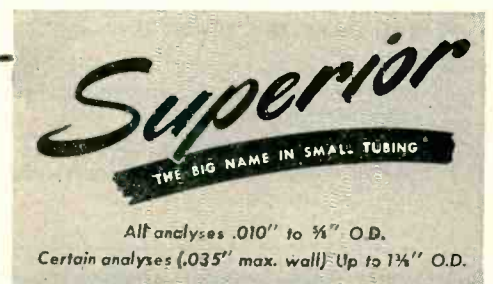

All analyses .010" to 1/4" O.D.
Certain analyses (.035" max. wall) Up to 1 1/4" O.D.

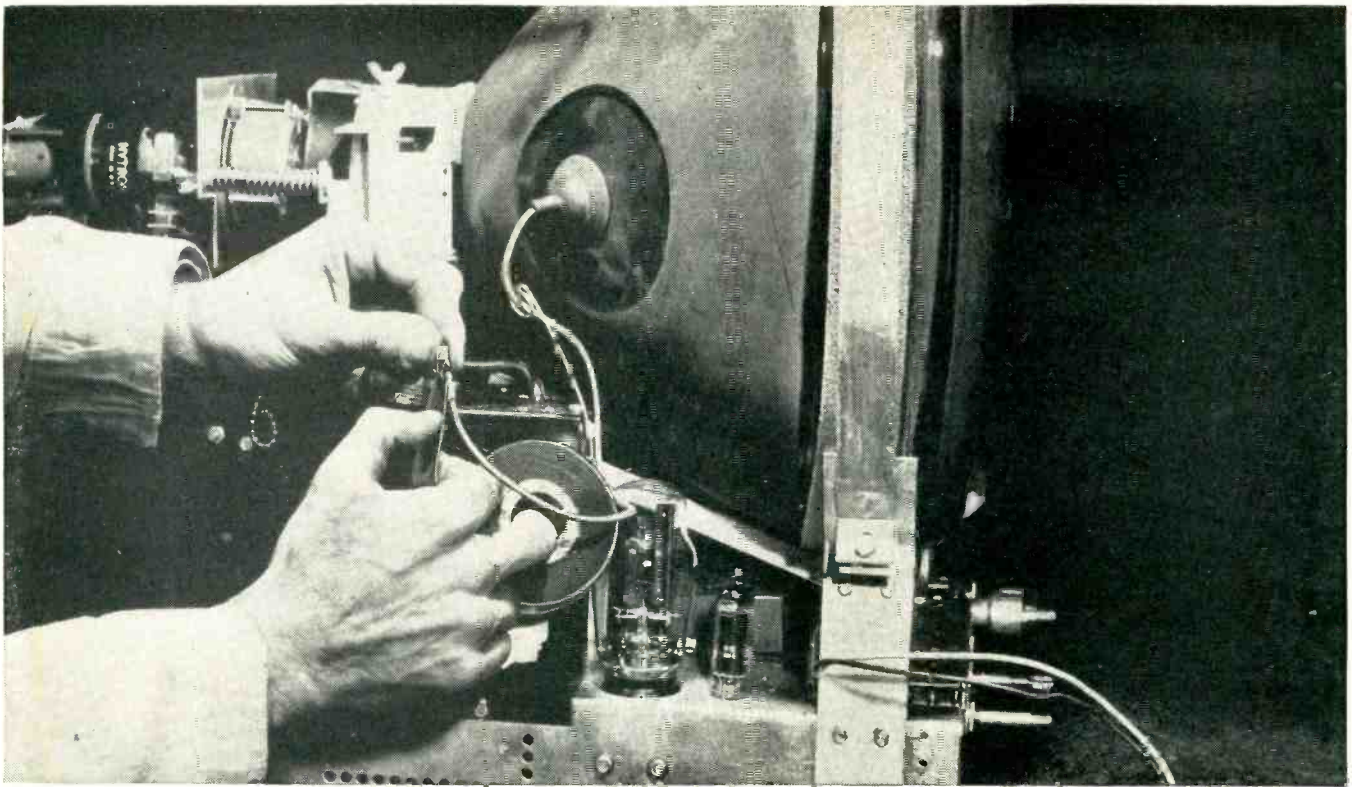

INSULATING SPLICE of high voltage lead to picture tube neatly, quickly with "Scotch" No. 33 Electrical Tape.

What's new in TV repair? Safe, speedy plastic tape!

More and more TV repairmen are saving money on service contracts with "Scotch" No. 33 Electrical Tape. This plastic-backed tape provides safe, snug protection for all wiring. Makes it easier to splice leads than to replace them! Difficult soldering is eliminated. Repair time is cut as much as 50%.

And customers are happier, too! Plastic tape in TV sets helps eliminate "snow" and "ghosts," improves signal-to-noise ratio.

Try "Scotch" No. 33 Electrical Tape on your next insulating job. Write Dept. ES-105 for complete information.

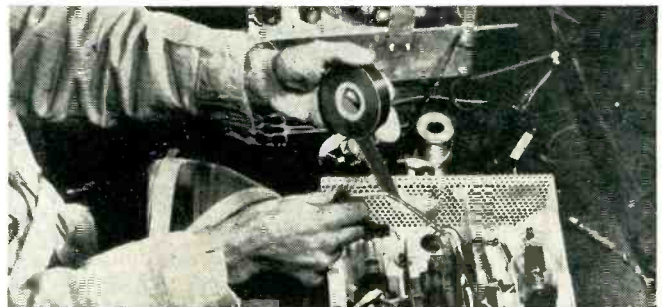

WRAPPING LEADS with "Scotch" No. 33 Electrical Tape prevents drying and cracking of original wire covering.

Quick facts about "Scotch" No. 33 Electrical Tape

- **THIN CALIPER**—only .007 inch thick, makes a neat wrap.
- **HIGH DIELECTRIC STRENGTH**—over 7,000 volts.
- **TOUGH**—plastic backing is abrasion resistant, unaffected by water, acids, alkalis, alcohols, exposure to sunlight, rain, snow, ice.
- **P.S.**—for perfect high-heat insulation try "Scotch" Electrical Tape No. 27 with thermosetting adhesive, glass-cloth backing.



Made in U.S.A. by MINNESOTA MINING & MFG. CO., St. Paul 6, Minn., also makers of other "Scotch" Brand Pressure-sensitive Tapes, "Scotch" Sound Recording Tape, "Underseal" Rubberized Coating, "Scotchlite" Reflective Sheeting, "Safety-Walk" Non-Slip Surfacing, "3M" Abrasives, "3M" Adhesives. General Export: Durex Abrasives Corp., New Rochelle, N.Y. In Canada: Canadian Durex Abrasives Ltd., Brantford, Ontario.

Federated ROSIN CORE SOLDER

Look for the orange package . . . the universally popular solder for use in electrical applications where bonding must be secure and free from corrosion.

The flux is in the solder . . . all you need is heat! Federated Rosin Core Solder is available in 1, 5, and 20-pound sizes.



Federated makes every commercial solder . . .

Asarco Body Filler Metal, acid-core, solid wire, spray-gun, and bar . . . purity and composition guaranteed by the world's leading supplier of solder.

Federated METALS

Division of AMERICAN SMELTING AND REFINING COMPANY
120 Broadway, New York 5, N. Y.
OFFICES IN PRINCIPAL CITIES ACROSS THE NATION



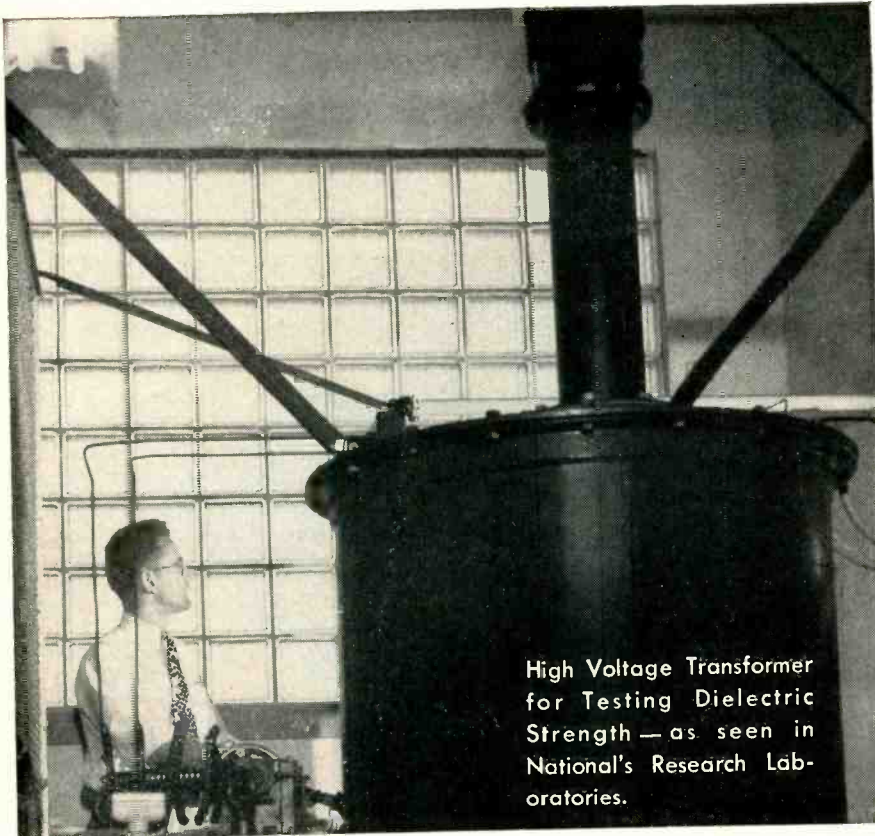

High Voltage Transformer for Testing Dielectric Strength — as seen in National's Research Laboratories.

National's Continuous Research ... the answer to your Improved Profitable Products

National, not only carries on a continuing quality control program in the manufacture of National Vulcanized Fibre and Phenolite to assure adherence to rigid specifications, but, is constantly seeking improvements in these products for the advancement of industries where plastics practically perform.

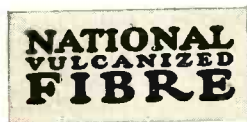

It will pay you to use—

A tough, horn-like material with high dielectric and mechanical strength. Excellent machinability and forming qualities, great resistance to wear and abrasion, long life, light weight. Sheets, Rods, Tubes, Special Shapes.



About one-half the weight of aluminum, possesses an unusual combination of properties—a good electrical insulator, great mechanical strength, high resistance to moisture; ready machinability. Sheets, Rods, Tubes, Special Shapes.

National Research and Engineering Service are available to you, without obligation—to help you solve your specific development problem. Write us—

NATIONAL VULCANIZED FIBRE CO.

WILMINGTON

Offices in



Since 1873

DELAWARE

Principal Cities

TUBES AT WORK

(continued from p 118)

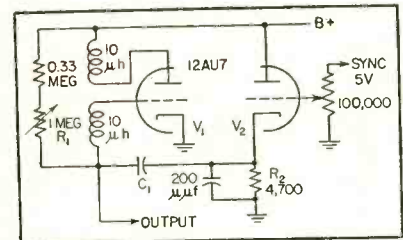

FIG. 1—Positive-grid blocking oscillator provides oscilloscope time base

inherently a good sawtooth, its shape unaffected by changes in circuit constants and voltages; frequency is substantially independent of plate supply; and sawtooth amplitude is independent of frequency.

Referring to Fig. 1, one half of a double triode is connected as a blocking oscillator, with the grid resistor returned to a high positive potential, conveniently the B+ supply. This bias linearizes the sawtooth voltage by making the total voltage across the grid or charging resistor large compared to the incremental voltage. Part of the grid resistor, R_1 , is variable as fine-frequency adjustment. Coarse-frequency control is effected by switching capacitors at C_1 .

The oscillator coil is not at all critical in design. Circuit in Fig. 1 uses two close-coupled windings of about 20 turns of No. 30 wire on a 3/8-inch form. Best results are obtained when both grid and plate coils are the same size with no tuning capacitors connected across them. Sawtooth amplitude increases with the Q of the coil, and is higher with low- μ tubes than with high- μ . The r-f frequency of oscillation is relatively unimportant. No attempt was made to design for "snap" operation, in which the discharge of the grid capacitor is effected in a single cycle of oscillation.

Synchronization

The other triode V_2 is used for the purpose of sync injection, and is connected as a cathode follower. The 200- μ f capacitor across the cathode resistor provides r-f bypassing. If very high sweep frequencies are not desired, a capacitor of 22 μ f or so from the grid of V_2 to ground will help improve

SPECIALLY DESIGNED FOR USE WITH SENSITIVE THERMO-REGULATORS

New ADLAKE No. 5000 Mercury Relay



Because of its amazingly high load-input ratio, the No. 5000 relay operates at 115 volts 60 cycles on *only* 0.007 ampere—a fraction of the current consumed by any other type of mercury relay!

It is ideally suited for use in electronic tube circuits where the output of the tube is limited. With its low amperage operating the coil, the contacts will handle 5 amperes at the same voltage—and tests indicate the No. 5000's life to be over 30 million operations!

It can be used as a pilot relay operating from a very sensitive thermo-regulator—serves equally well for high and low temperature control—and functions perfectly with either mercury-and-glass or bi-metal regulators.

FOR FULL INFORMATION on this sensational relay, write The Adams & Westlake Company, 1107 N. Michigan, Elkhart, Indiana. No obligation, of course.

Every ADLAKE Mercury Relay offers these advantages:

- Hermetically sealed—(dust, dirt, moisture, oxidation and temperature changes can't interfere with operation)
- Silent and chatterless
- Requires no maintenance
- Absolutely safe

Manufacturers of
Hermetically Sealed Mercury Relays for Timing;
Load and Control Circuits

THE
Adams & Westlake
COMPANY

Established 1857

ELKHART, INDIANA

New York • Chicago

STANDARD RI-FI* METERS

14 kc to 1000 mc!

DEVELOPED BY **STODDART**
FOR THE ARMED FORCES.

AVAILABLE COMMERCIALY.



VHF!
15 MC
to
400 MC
NMA - 5

Commercial equivalent of TS-587/U.
Sensitivity as two-terminal voltmeter, (95 ohms balanced)
2 microvolts 15-125 MC; 5 microvolts 88-400 MC. Field
intensity measurements using calibrated dipole. Frequency
range includes FM and TV Bands.



VLF!
14 KC
to
250 KC
NM - 10A

Commercial equivalent of AN/URM-6.
A new achievement in sensitivity! Field intensity measure-
ments, 1 microvolt-per-meter using rod; 10 microvolts-per-
meter using shielded directive loop. As two-terminal volt-
meter, 1 microvolt.



HF!
150 KC
to
25 MC
NM - 20A

Commercial equivalent of AN/PRM-1.
Self-contained batteries. A.C. supply optional. Sensitivity as
two-terminal voltmeter, 1 microvolt. Field intensity with 1/2
meter rod antenna, 2 microvolts-per-meter; rotatable loop
meter rod antenna, 2 microvolts-per-meter; rotatable loop
supplied. Includes standard broadcast band, radio range,
WWV, and communications frequencies.



UHF!
375 MC
to
1000 MC
NM - 50A

Commercial equivalent of AN/URM-17.
Sensitivity as two-terminal voltmeter, (50-ohm coaxial input)
10 microvolts. Field intensity measurements using calibrated
dipole. Frequency range includes Citizens Band and UHF
color TV Band.

Since 1944 Stoddart RI-FI* instruments have established the
standard for superior quality and unexcelled performance.
These instruments fully comply with test equipment require-
ments of such radio interference specifications as JAN-I-225,
ASA C63.2, 16E4(SHIPS), AN-I-24a, AN-I-42, AN-I-27a, AN-I-40
and others. Many of these specifications were written or re-
vised to the standards of performance demonstrated in
Stoddart equipment.

The rugged and reliable instruments illustrated above serve
equally well in field or laboratory. Individually calibrated
for consistent results using internal standard of reference.
Meter scales marked in microvolts and DB above one microvolt.
Function selector enables measurement of sinusoidal or complex
waveforms, giving average, peak or quasi-peak values.
Accessories provide means for measuring either conducted
or radiated r.f. voltages. Graphic recorder available.

*Radio Interference and Field Intensity.

Precision Attenuation for UHF!

Less than 1.2 VSWR to 3000 MC.
Turret Attenuator:
0, 10, 20, 30, 40, 50 DB.
Accuracy $\pm .5$ DB.

Patents applied for.



STODDART AIRCRAFT RADIO CO.

6644 SANTA MONICA BLVD., HOLLYWOOD 38, CALIF.
Hillside 9294

a complete line of

Rectifiers

Small, lightweight a-c to d-c power supply units for use with cathode-ray tubes, television camera tubes and radar indicator scopes, electron microscopes, and similar jobs. Typical outputs are 7, 9 and 13 kv. Low regulation—the 7-kv unit illustrated does not exceed 3.5% regulation per 0.1 milliamperere load, holds ripple on output voltage to less than 1%. Size, only 6" x 6" x 7"; weight 8 lb.

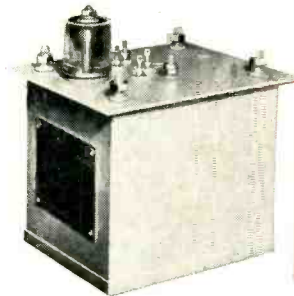

hermetically
sealed
oil-filled

HIGH-VOLTAGE COMPONENTS

Pulse Transformers

Pulse transformers for use with either hard-tube or line-type modulators. Available in voltage ratings of 10 kv or above. These units are ideal for radar applications, stepping up or down, impedance matching, phase reversing and plate-current measurements. Also suitable for nuclear physics research work, television and numerous special applications in and out of the communications fields.



Resonant Reactors

Resonant-charging reactors, accurately designed and constructed for radar service. Usually required in ratings of 40 kv and below, 1 ampere and below and 300 henries and below. Higher ratings are being built, and can be considered. When required, small- and medium-size designs can be provided with 3 to 1 range of inductance adjustment.



Filament Transformers

Filament transformers available with or without tube socket mounted integral with the high-voltage terminal. Low capacitance. Ratings to match any tubes; insulated to practically any required level.



Illustrated here are typical high-voltage components manufactured by General Electric. They can be built to meet Armed Services requirements. All are oil-filled and hermetically sealed—with excellent ability to withstand mechanical shocks and to operate continuously for long periods in widely varying temperatures. Apparatus Dept., General Electric Company, Schenectady, N. Y.

Your inquiries will receive prompt attention. Since these components are usually tailored to individual jobs, please include with your inquiry, functional requirements and any physical limitations. Write to Apparatus Dept., 42-328A, General Electric Co., Pittsfield, Mass.

GENERAL  ELECTRIC

401-63

The little **SHURE** cartridges

that fill the Big need

for High Fidelity

Phonograph Reproduction . .

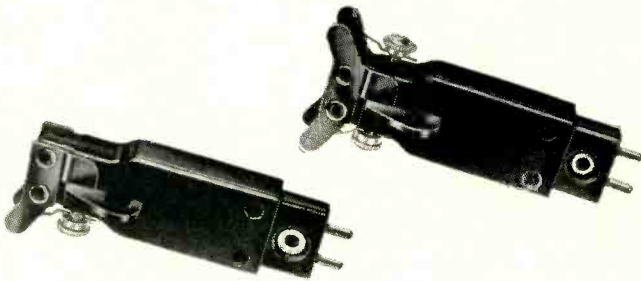

THE
NEW SHURE "VERTICAL
DRIVE"

CRYSTAL PICKUP CARTRIDGES

Big things often come in little packages . . . So it is with the superlative new Shure "Vertical Drive" Crystal Cartridges. They reproduce *all* the recorded music on the new fine-groove recordings—a reproduction that meets the strict requirements of high compliance and full fidelity. The "Vertical Drive" cartridges are requisite for the critical listener—the lover of fine music. They are especially recommended for those applications where *true fidelity* is essential.

SINGLE MODELS:
W 23 A for standard width-groove records.
W 21 A for fine-groove records.

TURNOVER MODELS:
W 22 A and W 22 A B for both standard and fine-groove recordings.

Unusually highly compliant, these "Vertical Drive" Cartridges will faithfully track standard records with a force of only 6 grams—micro-groove records with a force of only 5 grams (an added protection for treasured recordings). Will fit standard or special mountings. Have more than adequate output for the average audio stage.

SHURE

SHURE BROTHERS, INC.

Microphones and Acoustic Devices

225 WEST HURON STREET, CHICAGO 10, ILL. • CABLE ADDRESS: SHUREMICRO

the isolation of the sync source from retrace pulses.

The sync voltage required is higher than with gas triodes, but is not excessive. Less sync input is required at lower plate-supply voltages. Otherwise the plate voltage makes no difference except in the amplitude of the output wave. Voltages from 75 to 300 have been found satisfactory.

Trials with plate-blocked oscillators indicate that they are remarkably free of high-frequency limitations. Their inherent defect is that blocking action is proper only over a comparatively small range of charging resistance—not over 2 to 1. The best tube is a medium-mu triode with a high ratio of mutual conductance to plate current at low values of plate current.

BIBLIOGRAPHY

- O. S. Puckle, "Time Bases," Wiley, New York, 1943.
Kobayashi, U. S. Patent 1,913,449, 1929.
Chang, Series Sawtooth Oscillator, *ELECTRONICS*, p 178, Aug. 1950.
Sulzer, A Wide Range Sawtooth Generator, *Rev. Sci. Instr.*, p 78, Jan. 1949.
A. W. Keen, *Wireless Engineer*, 25, p 210, 1948.
Keats A. Pullen, *Proc. IRE*, 34, p 402, 1946.
J. L. Potter, *Proc. IRE*, 26, p 713, 1938.
Blocking Oscillator, *Rev. Sci. Instr.*, 12, p 510, Oct. 1941.
B. C. Fleming-Williams, A Single-Valve Time-Base Circuit, *Wireless Engineer*, p 161, April 1940.

Coaxial Feed System
for Antennas

BY JOHN F. CLEMENS

Project Engineer
Electronics Research Inc.
Evansville, Ind.

COAXIAL CABLE may be used to feed balanced horizontal antennas without interference, noise pickup or power loss due to unbalanced currents in the outer shield. The familiar delta match is used. The outer shield is bonded to the center of the antenna while a shorted section of cable resonates with the inductive reactance of the system.

Coaxial cable has advantages over unshielded or open-wire line in almost every transmission-line application. Generally speaking, attenuation is lower, making it particularly desirable when the line must be relatively long. For receiving applications the low noise pickup

**The shortest
distance
between guessing
and knowing**

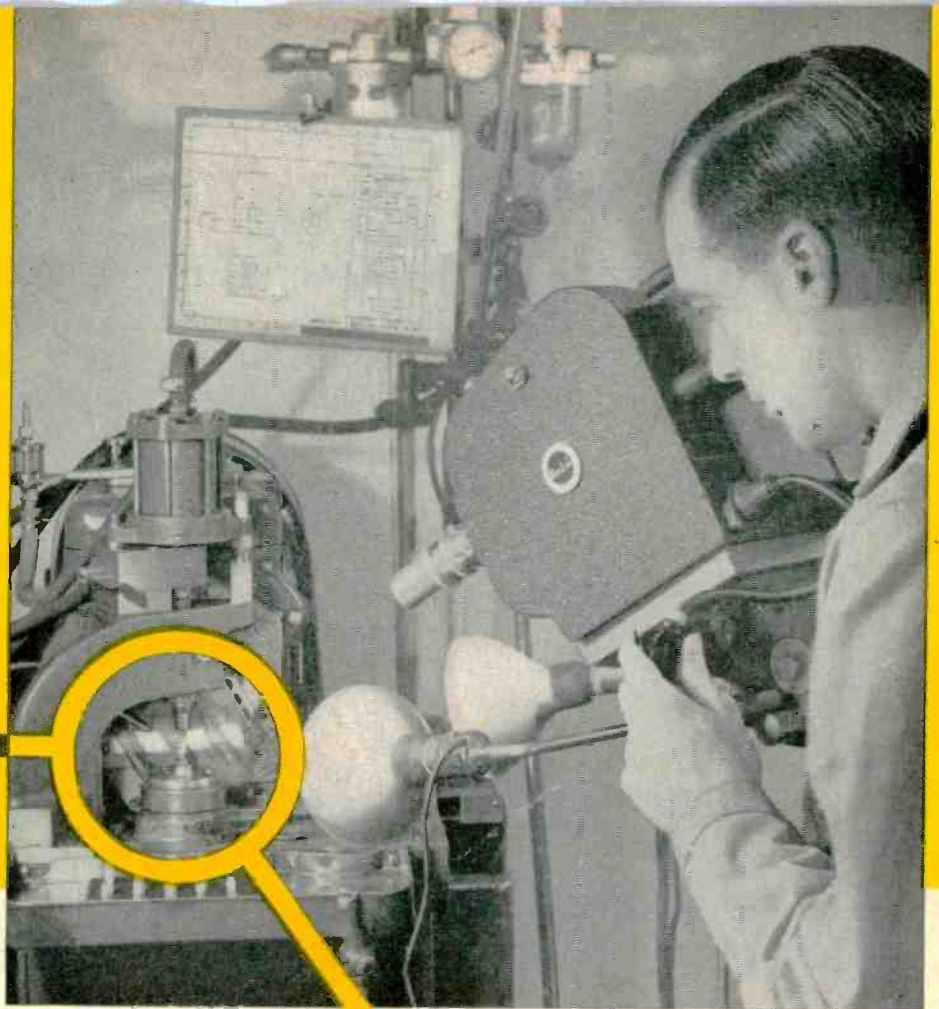

Fast-moving machines are hard to study under actual working conditions. But with high speed movies you can slow down fast action to a pace the eye can follow.

With the Kodak High Speed Camera you can take pictures of your problem (up to 3200 a second on regular 16mm movie film). Then you can see the operation clearly—enlarged on the projection screen—slowed down 200 times! You can see the reasons for excessive wear, faulty operation, noise, vibration, or early failure. What you see can point the way to better design, better methods, better performance.

High speed photography is not difficult, and its cost is small compared with the savings it makes possible. For more information, write for the booklet "Magnifying Time" or for loan of the 16mm demonstration film made with the Kodak High Speed Camera.

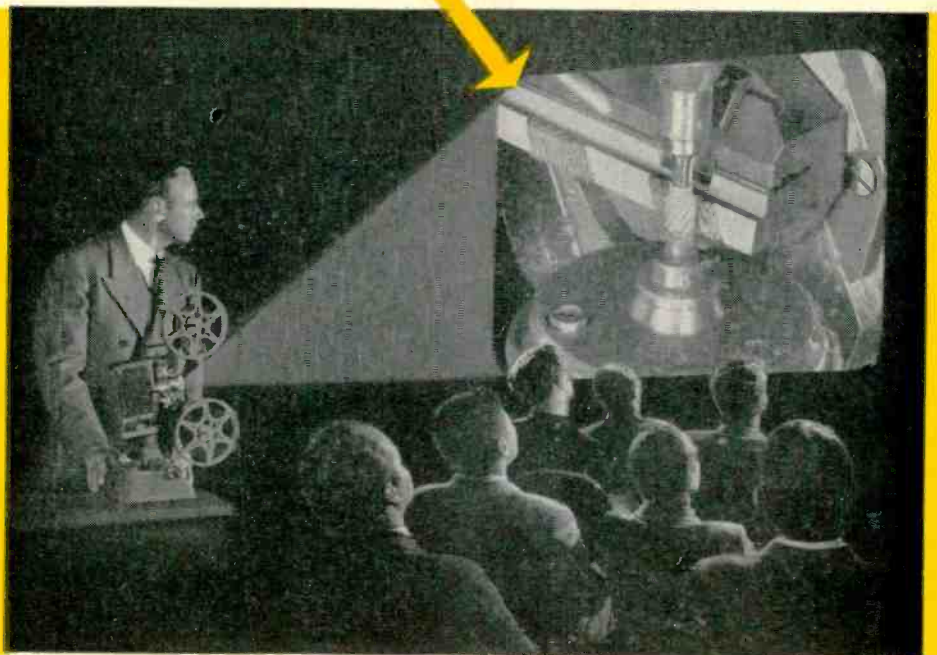

EASTMAN KODAK COMPANY, Industrial Photographic Division, Rochester 4, N. Y.

High-Speed Movies

... another important function of photography

Kodak
TRADE-MARK



Official U. S. Coast Guard Photo

easy
to see...

On a nice clear day finding an iceberg is pretty easy even though nine-tenths of its hulk remains below the surface.

But some other sea prowling isn't this simple. Locating submarines or sunken objects, charting the ocean floor or "seeing" the shape of the channel beneath calls for the use of intricate electronic devices.

Edo has been a leader in the research and development of depth-finding instruments and sonar equipment with which to find out much more easily and clearly what's below.

Already, Edo equipment, designed and manufactured for the United States Navy, is making possible new accuracy in underwater detection techniques.

UNDER-WATER "EYES"

Edo has developed and manufactured for the U. S. Navy a new sonar device which makes it possible to see the shape of the ocean floor both below and to either side of a ship.

Known as the Contour Bottom Scanner, the instrument gives a continuous picture of the bottom's profile on a cathode ray tube. It has many potential uses for navigating in shallow waters and locating sunken objects.

The C. B. S. is but one of a wide variety of electronic devices developed and perfected by Edo's highly qualified electronics engineers who have behind them Edo's twenty-five years of diversified experience in engineering, precision manufacturing, research and development.

For a complete picture of Edo's activities, you'll enjoy reading our recently published Twenty-Fifth Anniversary booklet. Write Dept. ES-4, Edo Corporation, College Point, N. Y. for your copy today.



EDO CORPORATION · COLLEGE POINT, N. Y.

YOU CAN BE **SURE**.. IF IT'S
Westinghouse



Single Phase Bridge Comparison
with only One Cell in Parallel*

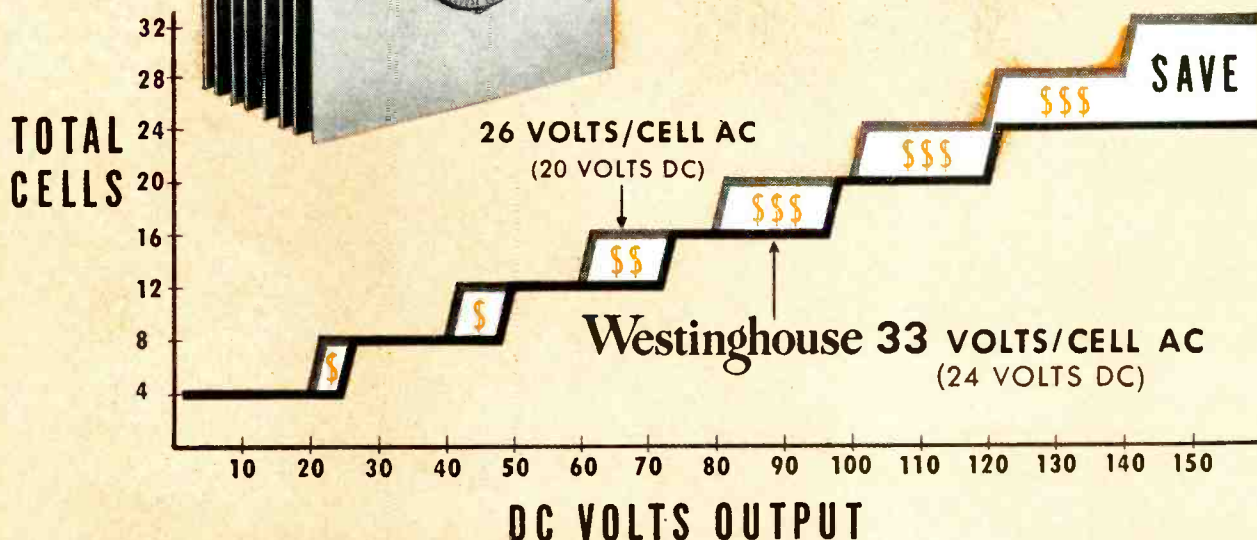

SAVE THE DIFFERENCE

with Rectox Selenium Rectifiers

The above graph shows, strikingly, the dollars and cents savings possible with Rectox Selenium Rectifiers.

The reasons?

High-voltage cells—24-volt d-c; 33-volt RMS compared to conventional 20-volt d-c; 26-volt RMS—mean fewer cells per watt output. And since each plate stands more voltage, smaller, lighter stacks result.

An exclusive Westinghouse process of manufacture assures lowest rate of forward aging and constant, uniform cell performance.

Test the Rectox under your own conditions. Try a sample. Figure your own savings—in space... in weight... in dollars. Phone or write your local Westinghouse office for details. Westinghouse Electric Corporation, P. O. Box 868, Pittsburgh 30, Pennsylvania. J-21591

*
In a bridge circuit, total savings are the product of: the cells saved in series (due to 24 volts d-c per cell) times 4 (the number of arms in the bridge) times the number of cells in parallel in each bridge arm. For example: A 4-5-3 connection cut to 4-4-3 by use of one fewer cell in series per arm means 1 saved x 4 x 3 or 12 total cells saved.



Westinghouse
Rectox
Rectifiers & Chargers for
ALL INDUSTRIES



Best for

ULTRA HIGH FREQUENCY NEEDS!

You can't beat the properties of Teflon when you're looking for hf and uhf insulators . . . and you'll never find more perfectly fabricated Teflon parts than those made by "John Crane".

Teflon insulators combine low dielectric constant, low loss factor, high heat resistance, toughness and resiliency.

As pioneers in the fabrication of Teflon products, we can fill your requirements. Scores of "John Crane" insulating spacers, connectors, beads, etc. are in use throughout the world on installations such as coaxial cables and radar units.

If you need Teflon insulators, let "John Crane" solve your problem. Write for full information

* John Crane products fabricated from DuPont Teflon are sold under the registered trade name "Chemlon".

JOHN CRANE

CRANE PACKING COMPANY

1802 CUYLER AVENUE • CHICAGO 13, ILLINOIS

Offices in all Principal Cities in United States and Canada



Don't Crystal Gaze

SELECT JK CRYSTALS AND BE SURE . . .

There's no guess work involved when you use JK stabilized crystals. Every JK crystal is manufactured with such care—and pride—that you can take it for granted there is none more dependable anywhere.

Next time you need crystals, specify JK crystals—and be sure!



JK STABILIZED HEAT JK02

JK stabilized heat—JK02 will accommodate two stabilized H17 crystals (HC6 type). Has standard octal base, 6.3 volt heater at less than 1 amp. Temperature stability $\pm 1^\circ\text{C}$. Oven is normally set at $+60^\circ\text{C}$. Can be supplied set at other temperatures on special order.



The James Knights Company

SANDWICH, ILLINOIS

of coaxial cable is a definite advantage. For this reason it is especially suitable for television receiving antenna leadins. Coax is entirely free from weather effects while the ribbon type of line is usually affected by rain and moisture, often deteriorating rapidly from exposure in coastal regions.

No Split Element

A system of coaxial-cable feed for balanced horizontal antennas should find wide application to television and f-m receiving antennas and transmitting antennas such as parasitic beams. The system described has a feature of prime importance in these applications: splitting the driven element is unnecessary. A feed system which necessitates breaking the antenna is difficult to fabricate since insulating materials of sufficient strength and electrical quality are not available for large self-supporting structures.

A serious problem in applying coaxial feed to a balanced antenna is that of eliminating unbalanced or antenna currents from the outer shield.¹ If present, such currents cause loss of the normal antenna pattern and the low noise pickup feature of coaxial cable. In transmitting, currents on the outer shield may cause feedback, interference or power loss.

The system described achieves balanced feedline currents as determined by test. In general, a symmetrical system can be relied upon for absence of unbalance effects. The diagram of the system, Fig. 1, discloses almost perfect symmetry.

Delta Match

The impedance between two symmetrically located points on an antenna rises from zero when the points are adjacent, to a very high value when the points are at opposite ends of the antenna. Therefore, in any type of resonant antenna, it is possible to select two points between which the resistive component of impedance is equal to the characteristic impedance of the transmission line. This is the basis for the familiar delta match.²

The impedance between two driving points is not purely resistive;

Insulate all these parts with tough **TEFLON** tape

New Du Pont plastic offers unusual
combination of electrical, mechanical and
thermal properties for:

REG. U. S. PAT. OFF.

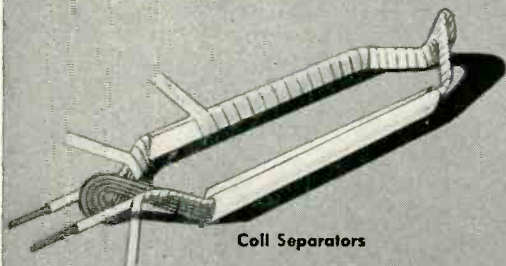

Coil Separators

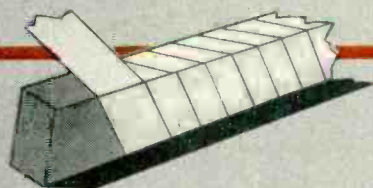

Conductor Insulation
for Armature or Field

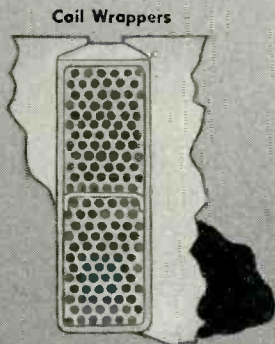

Coil Wrappers

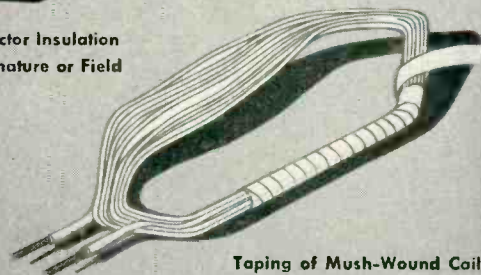

Taping of Mush-Wound Coils

Slat Liners

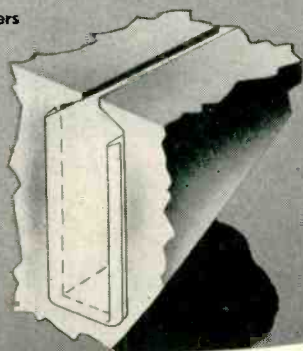

Lead Insulation

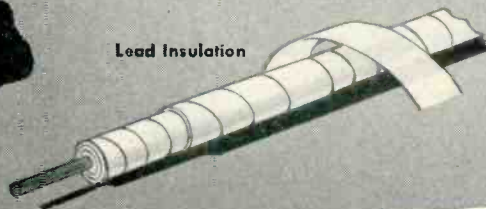

Look at these properties!

MECHANICAL "Teflon" tetrafluoroethylene resin is extremely tough—withstands considerable abuse in assembly and in use. Doesn't deteriorate with time. In applying, it's easy to handle, smooth, conforms well to corners and odd shapes—is adaptable to automatic operations.

ELECTRICAL Its electrical properties are excellent over wide ranges of temperatures and frequencies. Its power factor is less than 0.05% over the entire spectrum measured to date. Short-time dielectric strengths are high. "Teflon" has good arc-resistance, and doesn't carbonize under an arc discharge. It has zero water-absorption.

THERMAL "Teflon" is capable of continuous service at 250°C. (482°F.) without deterioration, exceeding the requirements of even Class H materials. In laboratory tests, molded bars kept at 250°C. for one month show only a 1% loss in tensile strength. "Teflon" also maintains good properties down to as low as -196°C. (-320°F.). Thus, an insulation of "Teflon" on a motor would not crack when motor is started in arctic temperatures.

CHEMICAL "Teflon" has the highest degree of chemical inertness of any plastic. There is no known solvent for it. Thus, it is ideal for motors and generators operating under corrosive atmospheric conditions. "Teflon" is unaffected by outdoor weathering, as well. Samples exposed in Florida for over five years are completely unchanged.

E. I. du Pont de Nemours & Co. (Inc.), Polychemicals Department, Sales Offices: 350 Fifth Avenue, New York 1, N. Y.; 7 S. Dearborn St., Chicago 3, Ill.; 845 E. 60th St., Los Angeles, Calif.

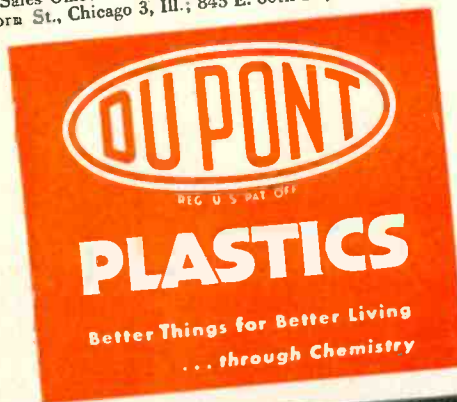

Write today for free booklet on "Teflon" Tape.

PICK A NUMBER

ANY FREQUENCY FROM 10 TO 1,000,000 C/P

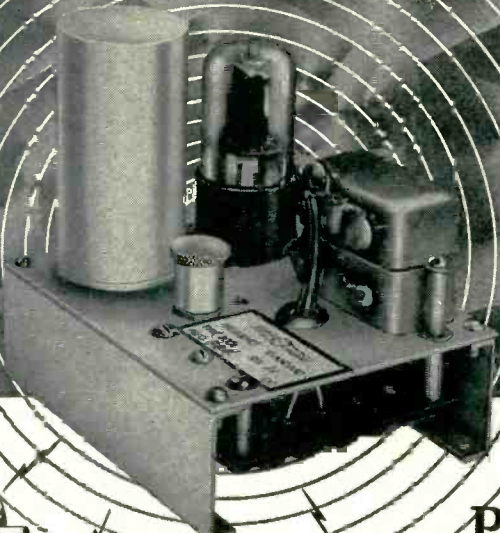

Pictured here is a tuning-fork frequency standard with accuracy guaranteed to one part per million per degree Centigrade. The fork is temperature-compensated and hermetically sealed against variations of barometric pressure. This standard, when combined with basic equipment, facilitates accurate speed and time control by mechanical, electrical, acoustical or optical means.

The unit is available separately or in conjunction with complete timing instruments. Our engineers are ready to cooperate on any problem.

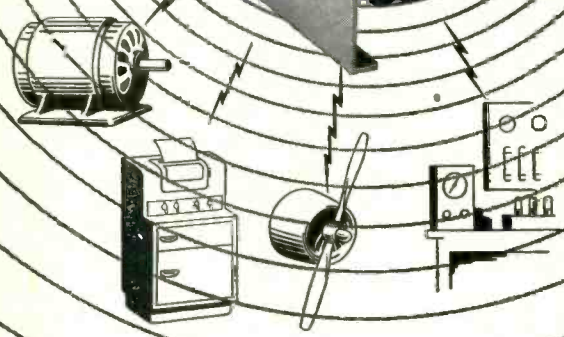

MOTORS • FACSIMILE • AIRCRAFT • LABORATORIES

American Time Products, Inc.

580 Fifth Avenue

New York 19, N. Y.

OPERATING UNDER PATENT OF THE WESTERN ELECTRIC COMPANY



*Longer Life
at 105°C!*

Temflex 105 extruded plastic tubing affords longer retention of flexibility and original insulation characteristics. Use it for higher operating temperatures, for high voltage conductors, for oil-cooled transformers. For details, test reports, samples, write today.

Look to Irvington
for Insulation Leadership

ENDURES HEAT – Temflex 105 is Underwriters' Laboratories approved for continuous operation at 105°C!

SUPERIOR INSULATION – Temflex 105 maintains consistently high dielectric strength!

MOISTURE RESISTANT – Temflex 105 effectively seals out moisture – is Underwriters' approved for use in damp locations!

STRONG, TOUGH – Temflex 105 gives you tensile strength of 3,000 p.s.i. – with minimum elongation of 300%!

FLEXIBLE WHEN COLD – Temflex 105 stays flexible down to temperatures as low as -40°C!

RESISTS CHEMICALS – Temflex 105 shows good resistance to solvents, is unaffected by strong acid or alkali!

WITHSTANDS HOT OIL – Temflex 105 retains flexibility and dielectric properties after prolonged immersion in oil over 100°C!



IRVINGTON

VARNISH & INSULATOR COMPANY

Irvington 11, New Jersey

MOSINEE

"More than Paper"



If you have a fabricating or processing problem involving paper . . . if you require definite technical characteristics and, above all, *dependable uniformity*, it may be worthwhile for you and MOSINEE technicians to get together. MOSINEE is not interested so much in terms of volume production as in our ability to render helpful service to manufacturers in the field of electronics and in the electrical goods industry. Our "paperologists" are at your service for consultation. Please write Dept. E.



MOSINEE PAPER MILLS COMPANY • MOSINEE, WIS.
Essential Paper Manufacturers

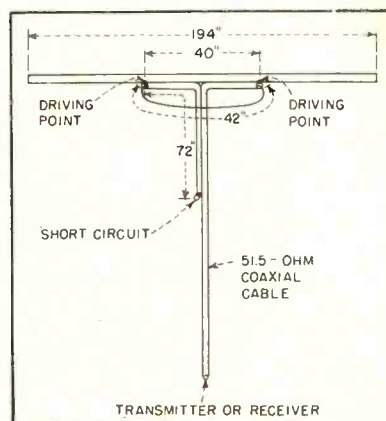

FIG. 1—Driven element of three-element close-spaced array for 29 mc using coaxial feed system

the actual impedance may always be represented by an equivalent series circuit of resistance and reactance. Prediction of the actual input impedance between two driving points is difficult in a parasitic array although approximate formulas are available for the half-wave dipole.³

The driving points must be chosen empirically to satisfy the requirement of an equivalent series resistive component equal to the characteristic impedance of the transmission line. Once these points have been determined, the series reactive component of the impedance may be calculated.

Shield Bonded

Assume that two symmetrically-located driving points have been located on the antenna. If the shield of a coaxial cable is connected to the center of the antenna, no antenna current will flow into the cable since the voltage at the center of the antenna is negligible. The cable may also be run along the antenna since it will act merely to increase its effective diameter. If protrusion of the inner conductor is negligible, no current will flow in the cable. Accordingly, it may be extended to one of the driving points. The shield should be well bonded to the antenna at this point.

The center conductor of the cable is looped past the center of the antenna to the opposite driving point. The coax sees a load resistance paralleled by the inductance of the length of the antenna element between driving points, and in series with the inductance of the ex-

You'll
**"STRIKE IT
 RICH"**, too

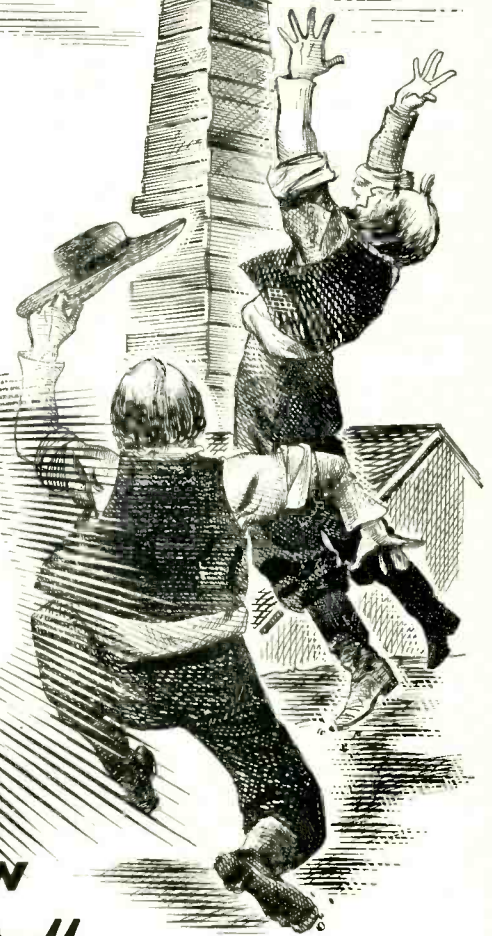
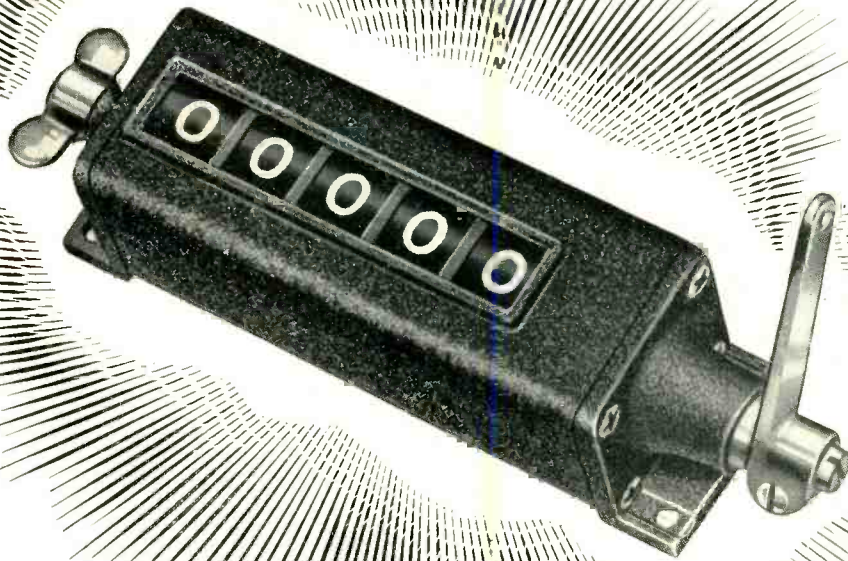

... if you can unearth a New
Sales-Building "COUNT-Ability"
 in your product!

It adds up as simply as 1-2-3, like this:

- 1: Take a new, objective look at your product . . . with a sharp "mathematical eye" . . . to see whether it could do more for your customers *if it could count*.
- 2: If you see the glimmer of a hidden Count-ability, call in a Veeder-Root engineer.

- 3: If he agrees that you've "got something" . . . and develops it into a new sales-promotion feature, then . . .

TO SUM UP, you build a Veeder-Root Counter into your product as an integral part . . . and proceed to bring in a "gusher" of new orders. Now, let's see if we can strike oil for you!

MEDIUM SIZE COUNTER (shown) counts strokes and turns, is built into scores of products from oil-well depth measures to tabulating machines and turnstiles. One of hundreds of V-R Counters, basic types of which are shown in FREE 8-PAGEBOOK. SEND FOR YOUR COPY TODAY.



Veeder-Root

COUNTERS

"Count Anything on Earth"

VEEDER-ROOT INC., HARTFORD 2, CONN.

In Canada: Veeder-Root of Canada, Ltd., 955 St. James Street, Montreal 3
 In Great Britain: Veeder-Root Ltd., Kilspindie Rd., Dundee, Scotland

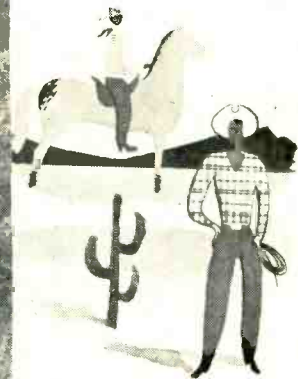
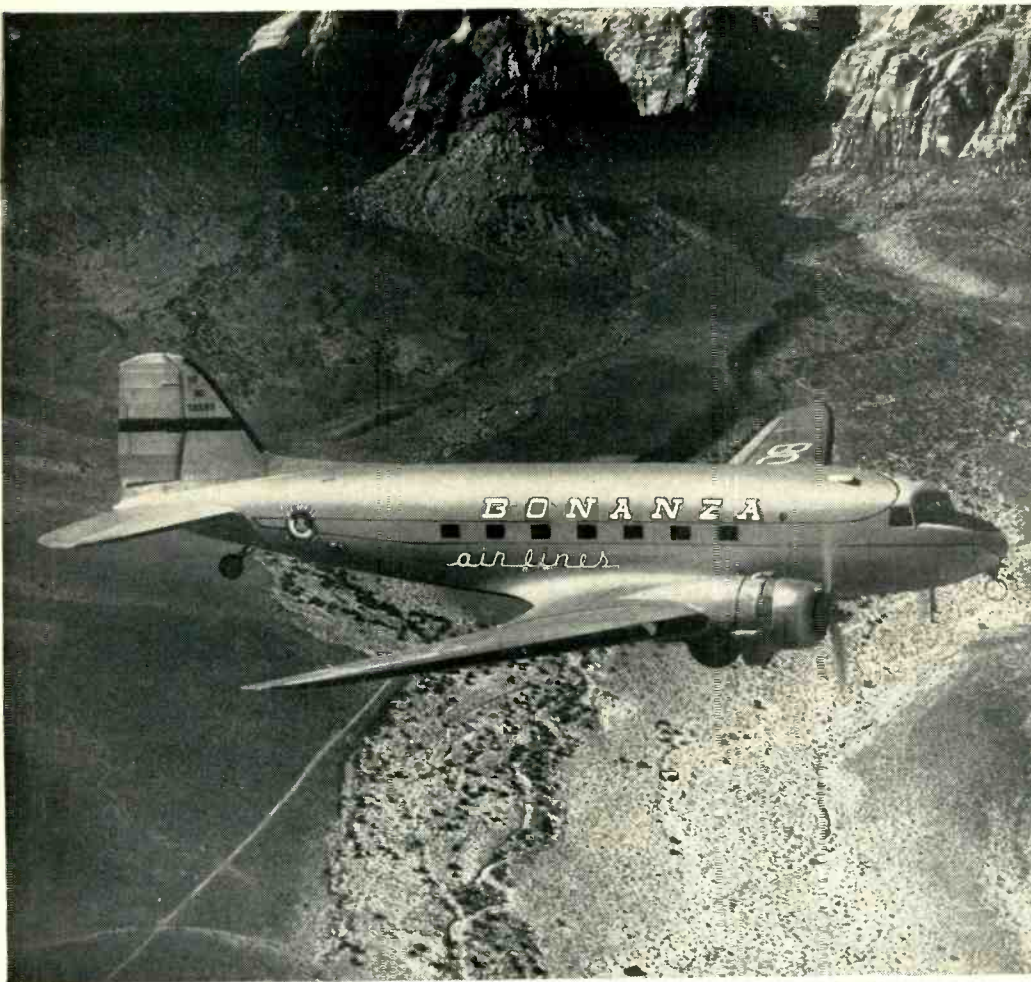

WILCOX

...First Choice of



**BONANZA AIR LINES SELECTS WILCOX TYPE 428
FACTORY PACKAGED VHF STATION For All Ground Stations**

A WILCOX Factory Packaged Station offers you:

1. OPERATING CONVENIENCE

Conveniently grouped controls, telephone handset, typewriter, filing cabinet, and writing desk assure efficient operation.

2. INSTALLATION ECONOMY

The 72-inch-high standard relay rack is completely wired at the factory. Just install the antenna, plug the station into any standard electrical outlet, and it's ready for operation.

3. MAINTENANCE EFFICIENCY

All adjustments are made from front panels. Plug and receptacle connections permit instant removal of all components. Simple circuits

minimize the number and types of tubes, require no special training or test equipment.

**DEPENDABLE COMMUNICATIONS
FOR THE WORLD'S AIR LINES**

In recent months many of the world's foremost air lines, UNITED, EASTERN, TWA, MID-CONTINENT, BRANIFF, PIONEER, ROBINSON, HAWAIIAN, SOUTHERN, and WISCONSIN CENTRAL, have placed volume orders for Wilcox equipment. No greater compliment could be paid to the performance, dependability, and economy of Wilcox equipment than to be "FIRST CHOICE" of this distinguished group.

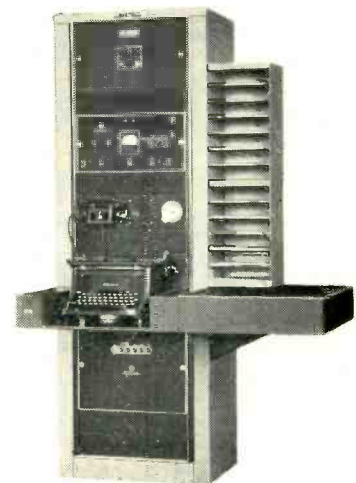

The Type 428 Packaged VHF Ground Station includes 50 watt Transmitter, Receiver, Power Supply, and Antenna.

Write Today... for complete information on the Wilcox Type 428 Packaged VHF Ground Station.

WILCOX ELECTRIC COMPANY

KANSAS CITY 1,



MISSOURI, U. S. A.

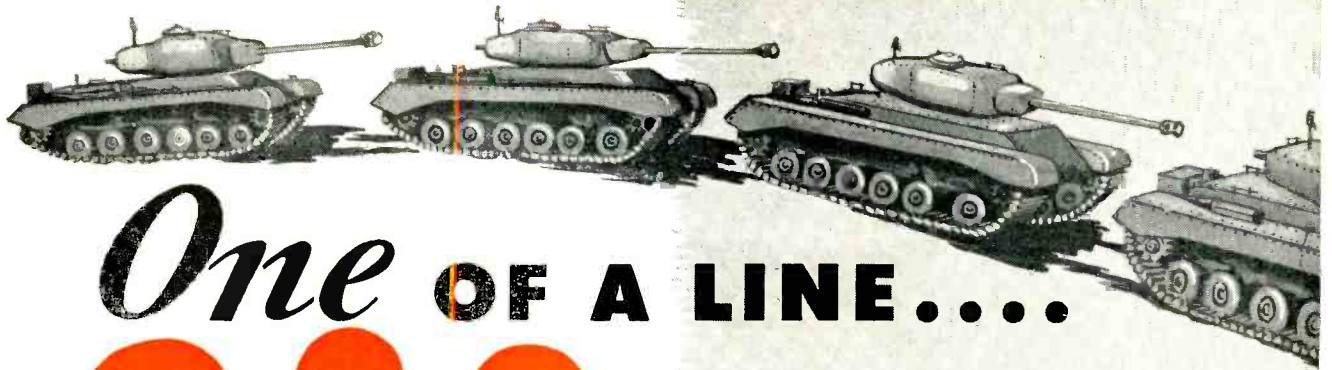

One OF A LINE....



Series 220 A.C.

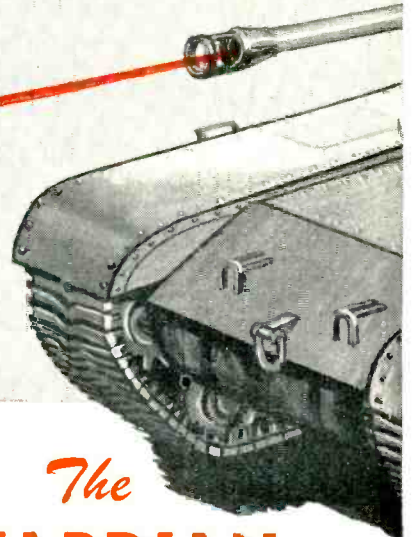

The
GUARDIAN
Series 220 A.C.
RELAY

A.N.
CONNECTOR
TYPE
MOUNTING



Guardian Control units—tiny A.C. relays to heavy-duty D.C. Solenoid contactors—are available in a wide range of specifications and mountings. *One of a line* of hermetically sealed relays is shown above with the A.N. Connector type container. Other hermetic seal containers incorporate the Octal Plug, Screw and Lug Header terminals. We invite you—get your cost-free copy of Guardian's Hermetically Sealed Relay Catalog now.

Series 220 operates as an A.C. Relay capable of breaking currents up to 20 amps. at 230 v., 60 c., A.C., non-inductive load. Contacts are same alloy used in Guardian Solenoid Contactors, specially compounded to withstand high loads. Dual contacts reduce arcing to a minimum. Standard hermetically sealed unit weighs 6.2 ounces. Highly insulated. Compact. Low priced.

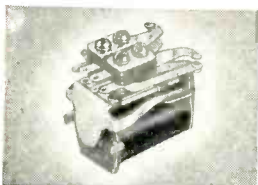

Series 595 D.C.

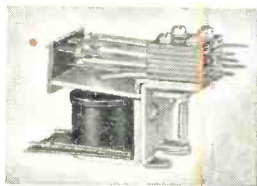

Series 210 A.C.—215 D.C.

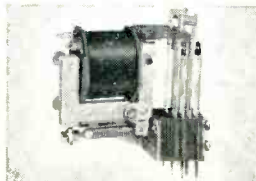

Series 30 A.C.

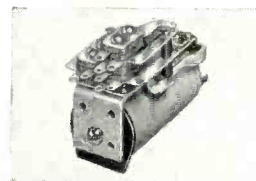

Series 695 D.C.

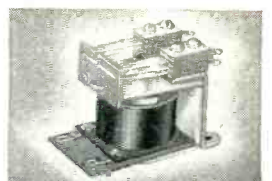

Series 610 A.C.—615 D.C.

Write—ASK US TO MAKE SPECIFIC RECOMMENDATIONS. NO OBLIGATION.

GUARDIAN  **ELECTRIC**
1675-L W. WALNUT STREET CHICAGO 12, ILLINOIS
A COMPLETE LINE OF RELAYS SERVING AMERICAN INDUSTRY

DIRECT WRITING RECORDERS

Records are produced by a heated writing stylus in contact with heat sensitive paper. The paper is pulled over a sharp edge in the paper drive mechanism (standard speed 25 mm/sec., slower available) and the stylus wipes along this edge as it swings, thus producing records in true rectangular coordinates. The writing arm is driven by a D'Arsonval moving coil Galvanometer with an extremely high torque movement (200,000 dyne cms per cm deflection).

This recorder assembly may be obtained in bare chassis form, as illustrated (51-600) with or without built-in timer; or, with the addition of a stylus heating transformer, temperature controls, and control panel (127); or, with the entire assembly, controls and control panel enclosed in a mahogany carrying case (127C). Complete catalog available, see below.

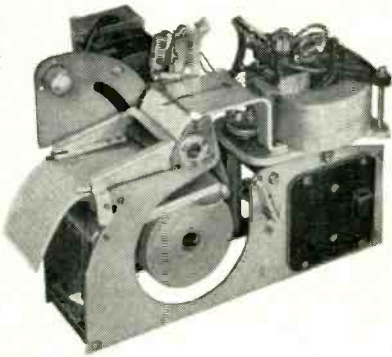

SINGLE CHANNEL
NO INK
RECTANGULAR COORDINATES
PERMANENT RECORDS

INSTRUMENT AMPLIFIERS

A general purpose, A.C. operated driver amplifier for use with model 127 Recorder, comprising three direct coupled push-pull stages. Maximum sensitivity 50 mv. per cm., minimum sensitivity 50 volts per cm., with four intermediate ranges. Balanced input terminals available with impedances of 5 megohms to ground. Complete information in catalog shown below.



AMPLIFIER-RECORDERS

Model shown at right is a single channel unit comprising above Amplifier 126 and Recorder 127, contained in one mahogany carrying case, and designed for use in the industrial field as a direct writing vacuum tube recording voltmeter capable of reproducing any electrical phenomena from the order of a few millivolts to more than 200 volts. More complete data in catalog shown below.

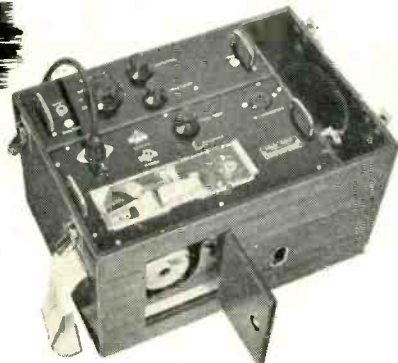

MULTI-CHANNEL
NO INK
RECTANGULAR COORDINATES
PERMANENT RECORDS

At lower right is a typical "Poly-Viso" multiple channel direct writing Recorder and Amplifier in console. Numerous combinations of this recording equipment and associated amplifiers and accessories are available. The Multi-channel Recorder (Model 165) provides for the simultaneous registration of up to four input phenomena, using the same principles and method as for the Recorder Assembly above. In addition, the "Poly-Viso" Recorder provides a selection of eight paper speeds: 50, 25, 10, 5, 2.5, 1.0, 0.5 and 0.25 mm/sec., and for the use of 4, 2, or 1 channel recording Permapaper. The Amplifier equipment is housed in a rack which has space for four individual driver amplifiers (electrically identical to model 126, above) and one 4-channel preamplifier.



For complete catalog giving tables of constants, sizes and weights, general description, and prices, address:

SANBORN COMPANY
 Industrial Division
 CAMBRIDGE 39, MASS.



Sanborn Recorders and Amplifiers have evolved from those originally designed by Sanborn Company for use in electrocardiographs, and have, by actual practice, proven to have wide applications in the Industrial field as well.

tended center conductor. The inductance of both antenna and center conductor can be determined from:

$$L = 0.00508 a \left(2.303 \log \frac{4a}{d} - 0.75 \right) \quad (1)$$

where a and d represent length and diameter of each conductor in inches, and L is given in μh .

The actual equivalent circuit is shown in Fig. 2A where R_p is unknown while L_p , the inductance of the length of antenna between driving points, has been calculated.

The inductance of the extended center conductor, L_s , may likewise be calculated. In Fig. 2B the parallel circuit of R_p and L_p has been replaced by the series equivalent R_s and L_s . In this case, R_s is the characteristic impedance of the line. Inductance L_s may be calculated from

$$X_p = \frac{X_s^2 + R_s^2}{X_s} \quad (2)$$

$$R_p = \frac{X_s^2 + R_s^2}{R_s} \quad (3)$$

$$X_s = \frac{X_p + \sqrt{X_p^2 - 4R_s^2}}{2} \quad (4)$$

Resistance R_p may be determined likewise if desired.

Resonating Load

Once X_s has been determined the next step is to combine it with the reactance of L_2 and insert a capacitance, C , of such a value to resonate

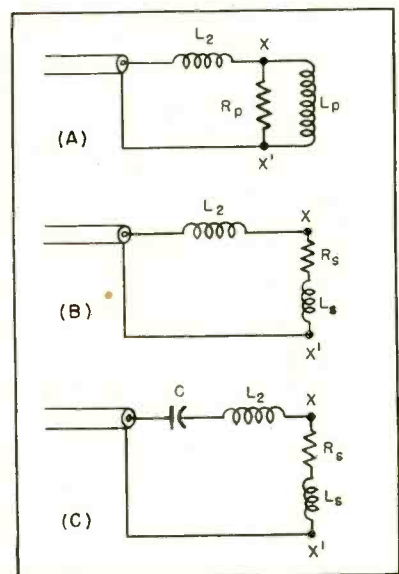
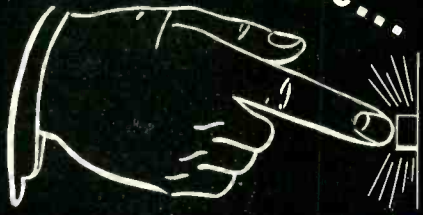

FIG. 2—Equivalent circuits of coaxial feed system show effect of shorted line and distributed inductance

It's that Simple...



... Automatic Push-Button Tuning

An
Exclusive
Feature of
the New

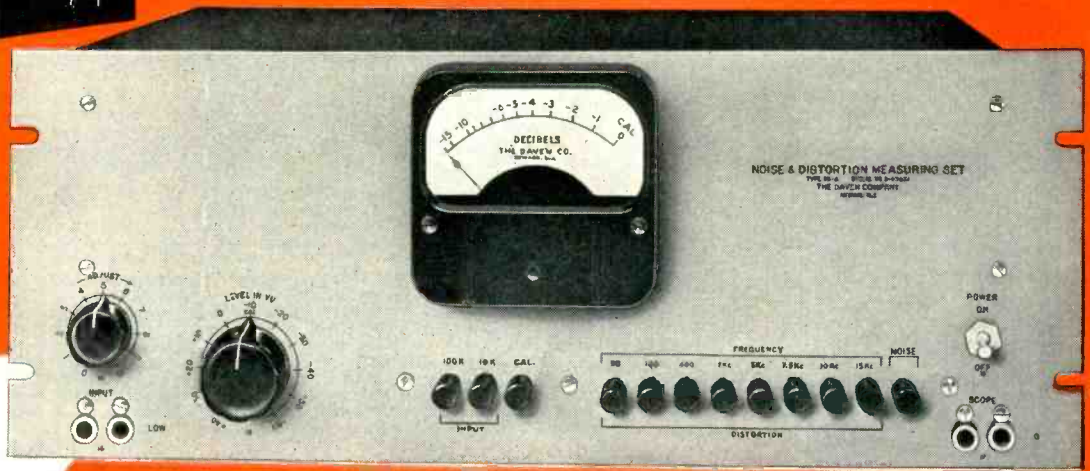

DAVEN

Distortion and Noise Meter Type 35-A

The DAVEN Type 35-A, Distortion and Noise Meter, is a new, skillfully engineered instrument that provides a rapid, accurate means of measuring distortion, noise and hum level in audio frequency equipment.

Of particular importance is the fact that there is no balancing or laborious time consuming tuning required to make measurements. The user need only push a button and the unit is automatically balanced.

This is accomplished by the use of a series of 8 fixed band rejection filters covering the range 50 cycles to 15 K.c., followed by a stable, high quality, wide range (50 cycles to 45 K.c.), high gain amplifier. There are no tube circuits or other sources of inherent distortions, making it possible to measure low levels of distortion accurately over a wide level range.

SPECIFICATIONS

RESIDUAL DISTORTION: No tube circuits or non-linear devices between input of set and filter input.

DISTORTION MEASUREMENTS: Filters provided for 50, 100, 400, 1000 cycles, 5 Kc, 7.5 Kc, 10 Kc, and 15 Kc with cut off of -70 db. Distortion measurements to 0.1% full scale meter deflection with zero level input.

NOISE MEASUREMENTS: With zero db input, limit is -80 db. At +40 input, limit is -115 db below input.

AMPLIFIER FREQUENCY RANGE: 50 cycles to 45 Kc.

ACCURACY: Filters are down 70 db at fundamental frequencies, and within ± 0.5 db of flat response at the second harmonic. Absolute accuracy of measurement can be depended upon to be within $\pm 5\%$.

RESIDUAL NOISE LEVEL: Below -80 db at gain control full on. Multiple gain control employed so that residual noise drops to -90 db. when gain control is set at -30, -100 db when gain control is set at -20, etc.

Write
for
detailed
information

THE **DAVEN** CO.

191 CENTRAL AVENUE
NEWARK 4, N. J.

SEE DAVEN AT THE
AUDIO FAIR, ROOM 616

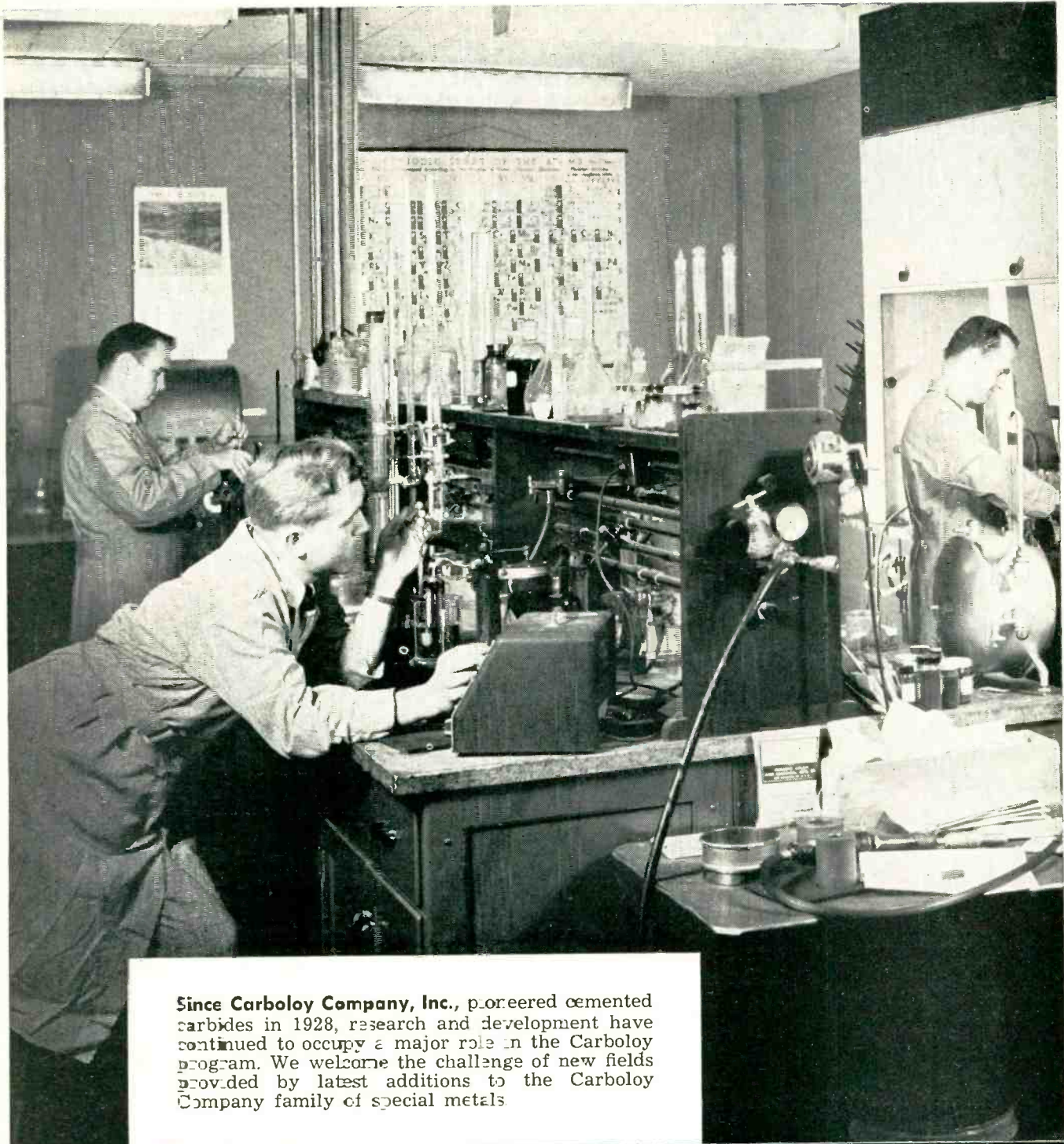

Since Carboloy Company, Inc., pioneered cemented carbides in 1928, research and development have continued to occupy a major role in the Carboloy program. We welcome the challenge of new fields provided by latest additions to the Carboloy Company family of special metals.

LOOK to CARBOLOY CO.,
INC.
for the finest in special metals

CARBIDES • **ALNICO** • HEVIMET

NEW INTERLEAVE COIL WINDER IS FULLY AUTOMATIC

Universal's new high speed automatic No. 107 winder produces accurately-wound paper-insulated or acetate-insulated coils at a very high rate of output.

Automatic feeding Single or laminated insulating sheets are fed into the machine automatically. Rate of feed, with either paper or acetate, can be as high as 25 inserts per minute.

Thus, on a coil containing 100 wire turns per layer, the machine can be operated at winding speeds up to and including 2500 rpm.

An entirely new type of delivery shelf has been designed to provide high accuracy. It imparts a uniform backward pull on the paper as it is fed into the coil, resulting in windings of highest possible density.

This delivery shelf will handle insulating papers, either "Kraft" or "Glassine," from .0006 in. to .003 in. in thickness, and where the machine is equipped with devices for removing static, acetate sheet is handled at high winding rates.

The machine utilizes a single width of insulating paper, and this can be 24 in. or up to 25 in. maximum if required.

Accurate wire control Wire sizes accommodated range between No. 19 and No. 42 (B&S). The creel stand is independently mounted, and holds up to 30 wire spools at a time.

The wire spool spindle is of the latest design, with solid construction. The braking device is mounted on the rear of the ma-

chine to give better balance between the wire spools and the higher winding speed.

Efficient winding A quick return of the wire guides is assured at the end of each wire layer, and thus there is no possibility of crossed turns due to delayed return, particularly where wear develops.

The same efficient traverse mechanism used in the Universal No. 105 Coil Winder has been adopted for the No. 107. No changes in cam are necessary for various lengths of wire layer.

Special attachments These include an auxiliary "space-wind" traverse for spacing the first and last layers of high-tension coils. A special "mid-tap" attachment permits shifting the wire guides at the end of a wire layer for "tap"

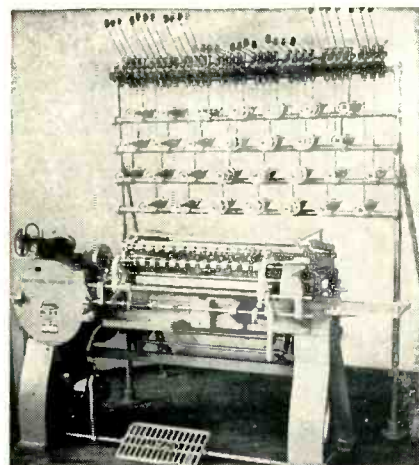

No. 107 Universal Coil Winder.

location or to arrange for starting and finishing leads.

Where required, a "dual-counter" is available so that the machine will stop automatically for the removal of a mid-tap.

The new No. 107 Coil Winder has already demonstrated, in preliminary installations in plants of several prominent electrical manufacturing firms, its ability to turn out coils of the highest quality.

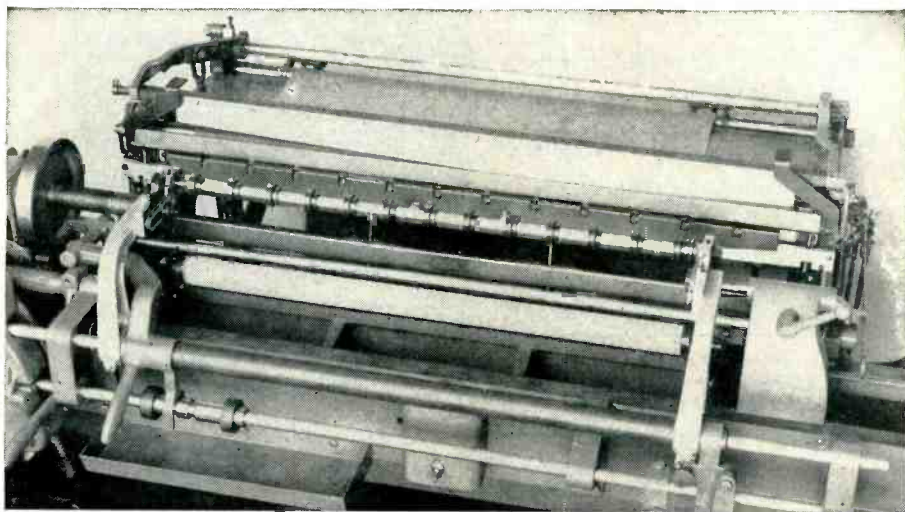

Closeup showing coil arbor in transfer position.

UNIVERSAL WINDING COMPANY

P. O. Box 1605 Providence 1, R. I.

* REG. U. S. PAT. OFF.

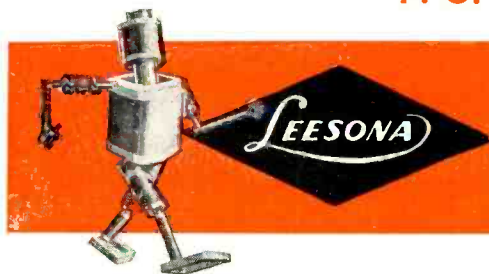

FOR WINDING COILS IN QUANTITY
ACCURATELY . . . AUTOMATICALLY
USE UNIVERSAL WINDING MACHINES

BALLANTINE

STILL THE FINEST

in

ELECTRONIC VOLTMETERS

Ballantine pioneered circuitry and manufacturing integrity assures the maximum in
SENSITIVITY • ACCURACY • STABILITY

- All models have a single easy-to-read logarithmic voltage scale and a uniform DB scale.
- The logarithmic scale assures the same accuracy at all points on the scale.
- Multipliers, decade amplifiers and shunts also available to extend range and usefulness of voltmeters.
- Each model may also be used as a wide-band amplifier.



MODEL 300

MODEL	FREQUENCY RANGE	VOLTAGE RANGE	INPUT IMPEDANCE	ACCURACY	PRICE
300	10 to 150,000 cycles	1 millivolt to 100 volts	1.2 meg. shunted by 30 mmfds.	2% up to 100 KC 3% above 100 KC	\$200.
304	30 cycles to 5.5 megacycles	1 millivolt to 100 volts except below 5 KC where max. range is 1 volt	1 meg. shunted by 9 mmfds. on low ranges and 4 mmfds. on highest range	3% except 5% for frequencies under 100 cycles and over 3 megacycles and for voltages over 1 volt	\$225.
305	Measures peak values of pulses as short as 3 microseconds with a repetition rate as low as 20 per sec. Also measures peak values for sine waves from 10 to 150,000 cps.	1 millivolt to 1000 volts Peak to Peak	2.2 megs. shunted by 8 mmfds. on high ranges and 15 mmfds. on low range	3% on sine waves 5% on pulses	\$280.
310	10 cycles to 2 megacycles	100 microvolts to 100 volts	Same as Model 305	3% below 500 KC 5% above 500 KC	\$225.

For further information, write for catalog.

BALLANTINE LABORATORIES, INC.

100 FANNY ROAD, BOONTON, N. J.



the total inductive reactance as shown in Fig. 2C. A capacitor of capacitance C may be inserted in the center conductor anywhere along its length to obtain an impedance match.

Usually a capacitor is not used because of weather effects. Instead, a length of cable may be used to present the same capacitive reactance. Although a length of either open or shorted cable may be used, the shorted cable is preferable because of its lower loss. If a shorted cable is used the proper electrical length may be computed from

$$X = -j Z_k \tan \theta \quad (5)$$

where X is the desired capacitive reactance. The electrical angle θ may be converted to inches from

$$D = \frac{(32.8)(\theta)(v_p)}{f} \quad (6)$$

where θ is expressed in degrees, f in megacycles and v_p , the propagation velocity, as a fraction.

The matching section and antenna may be bonded along their mutual length without altering the performance of either.

Allowable Mismatch

The fact that the antenna inductance, L_a , shunts the resistive component, R_a , permits the system to be used when the radiation resistance exceeds the characteristic impedance of the line. A 50-ohm coaxial cable may thus be matched to a free-space dipole having a radiation resistance of 73 ohms.

The cable may be fed inside a tubular antenna element with the center conductor emerging through a hole at one driving point and re-entering the antenna tube at the other driving point.

Experimental Antennas

A test of the system was first made at 300 mc with a close-spaced three-element parasitic array. Instead of the capacitive line section, a small variable capacitor was used. A standing wave ratio of less than 1.5 to 1 was readily obtained. Antenna elements were 3/16 silver-plated brass rods and the feed line was RG-58/U.

The system was next tested on a scaled-up version of the three-element antenna at 29 mc. Spacing

FOR ARMED SERVICES COMPONENT REQUIREMENTS—1N69 AND 1N70



Welded GERMANIUM DIODES

MEET
JAN SPECS

SPECIFICATIONS

Max Ratings at 25°C	1N69	1N70
Peak Inverse Voltage	75	125
Max Continuous Inverse Voltage	60	100
Average Rectified Current (ma)	40	30
Peak Rectified Current (ma)	125	90
Surge Current (ma)	400	350
Temp. Range °C	-50 to +70	-50 to +70
Characteristics at 25°C		
Max Inverse Current at -50v(ma)	.85	.41
Max Inverse Current at -10v(ma)	.05	.01
Min Forward Current at +1v(ma)	5.0	3.0
Average Shunt Capacitance (mmfd)	0.8	0.8

GENERAL ELECTRIC germanium diodes must meet the most rigid specifications, yet volume production continues to drive their prices steadily downward. Compare new G-E prices with all others . . . then check the following reasons for this ever-widening acceptance among electronics designers, engineers, and equipment makers:

Dual Mounting—For Convenience—Versatile G-E diodes can be mounted two ways: *clip them into place* by means of their husky, non-oxidizing nickel pin terminals . . . or use each diode's well-tinned, copper-clad steel leads to *solder* it into the circuit. These special leads are strong and flexible, conduct less heat than ordinary types, and thus prevent damage during soldering.

Platinum Whisker—For Strength—To assure stability and long life, the G-E diode's pigtail whisker is of platinum, which, unlike tungsten, can be strongly welded to germanium.

Moisture Resistant Insulating Case—For Protection—A special insulating case of molded, mineral-filled phenolic protects this unique welded contact. The case is also tapered to assure correct polarity mounting. These diodes are so easy to handle—you can install 'em in the dark!

Looking For A Long Life Diode? We've got 'em! The complete G-E line includes four general purpose diodes, two JAN types, two TV types (more than half a million of these have already been supplied to TV receiver manufacturers), one u-h-f model and the high quality quad of four balanced diodes. For product and application engineering service, inquire at the G-E electronics office near you, or write: *General Electric Company, Electronics Park, Syracuse, N. Y.*

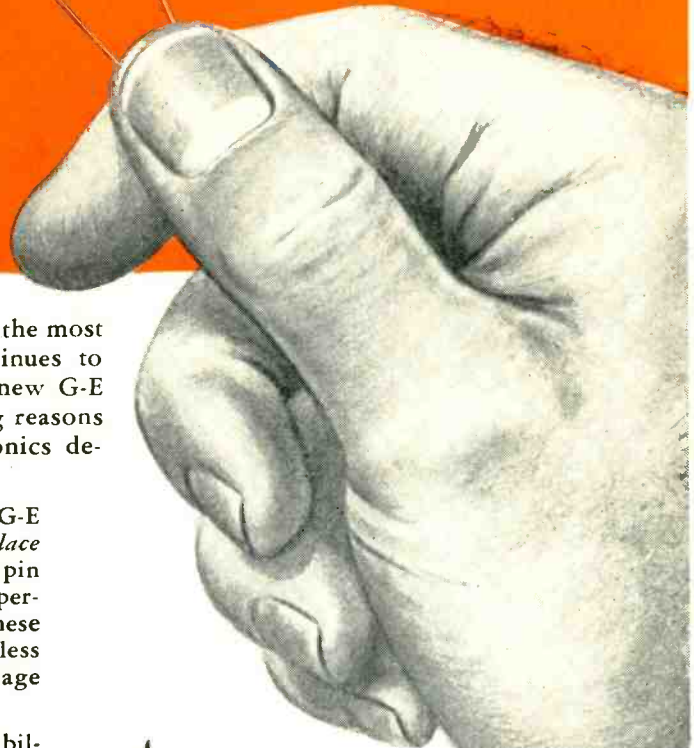

**GET YOURS NOW!
OVER 2500 COPIES
SOLD ALREADY!**

DANNY DIODE

**NEW
DIODE
HANDBOOK**



Now in 2nd Printing! Here are 68 pages of facts on characteristics, advantages, and circuitry of diodes. Charts, curves, diagrams, typical applications. Leatherette bound, loose-leaf style. Supplementary sheets furnished free as published. Worth many times its modest price of \$1.25. Send check or money order to: *General Electric Company, Section 4100 Electronics Park, Syracuse, New York.*

You can put your confidence in—

GENERAL  ELECTRIC

What's Your
PANEL INSTRUMENT
Problem?

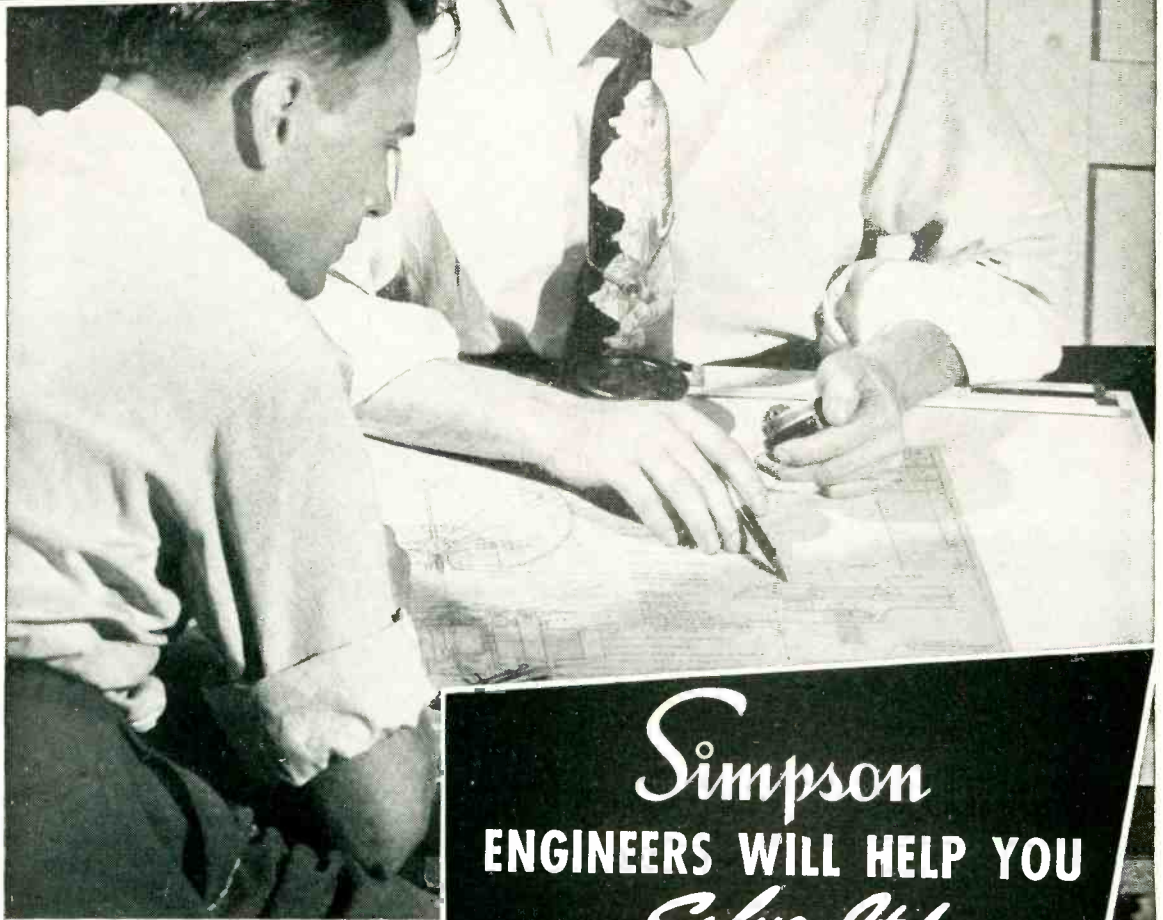

Simpson
ENGINEERS WILL HELP YOU
Solve It!

No matter what your panel instrument problem is, Simpson Electric Company engineers will be glad to help you solve it. Every day they are confronted with individual design problems.

Behind every Simpson instrument is a world-wide reputation for quality. Simpson movements have greater ruggedness and accuracy, because of the full bridge-type construction and soft iron pole pieces.

When Simpson helps you with your problem, you benefit from this world-wide reputation and the years of experience of Simpson engineers.

Let Simpson engineers help you with your next instrument problem and for your standard instrument requirements take advantage of our large stock, available for immediate delivery.

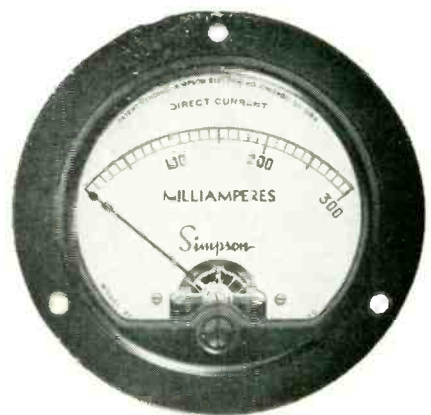

SIMPSON ELECTRIC COMPANY

5200-18 WEST KINZIE STREET, CHICAGO 44, ILLINOIS
IN CANADA: BACH-SIMPSON, LTD., LONDON, ONTARIO

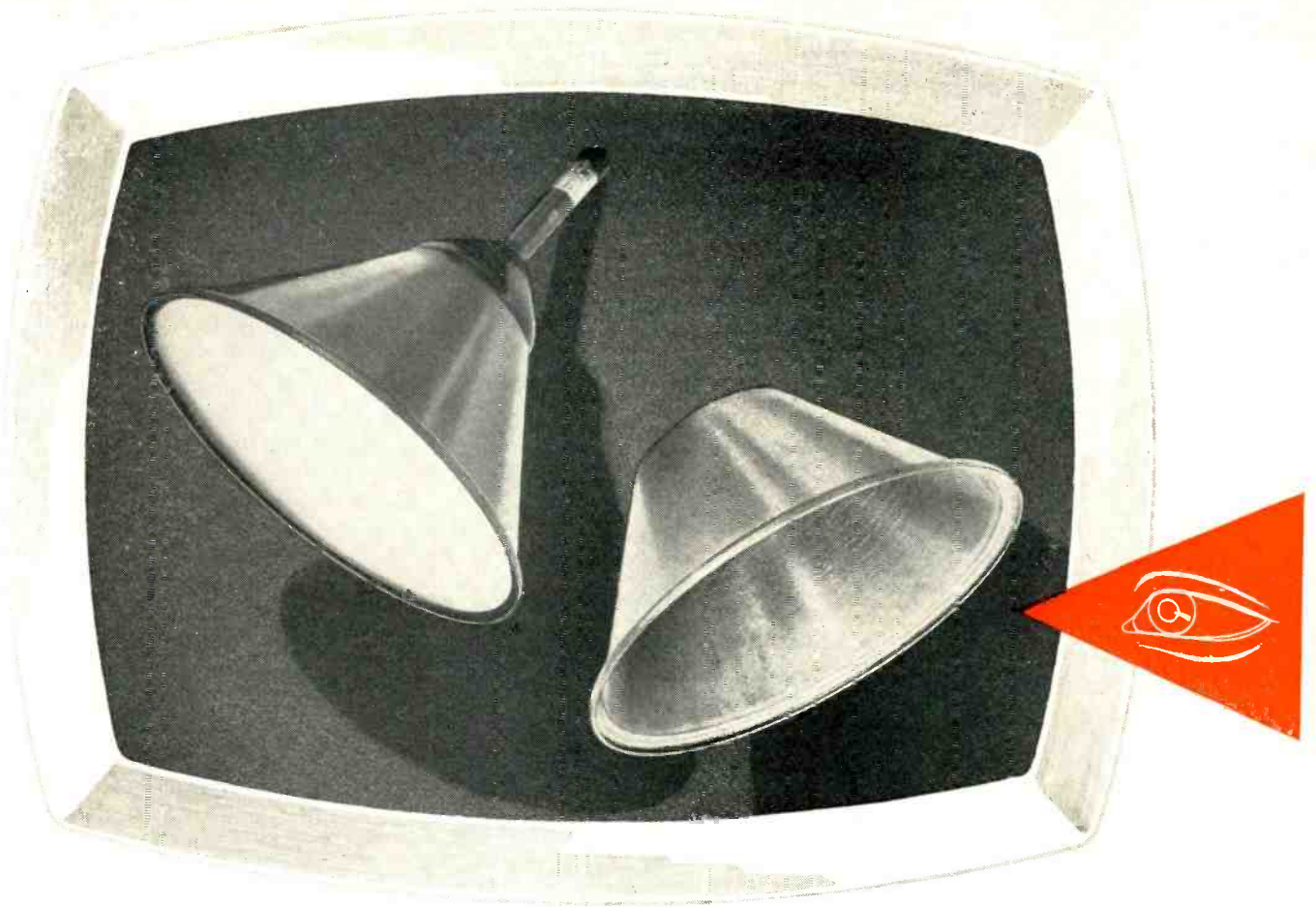

U·S·S Stainless Steel is in the television picture

PICTURE TUBE CONES OF U·S·S 17-TV

REDUCE WEIGHT, HELP CUT COSTS

PUBLIC demand for bigger and better television at low price has brought manufacturers face to face with new problems in reducing weight and holding down set cost. And, like so many other industries, television has turned to Stainless Steel to solve this problem.

A new grade of U·S·S Stainless Steel, known as U·S·S 17-TV, has been developed especially for this television application. Having an appropriate coefficient of expansion, it permits fusing of the faceplate and neck to the metal cone with a strong air-tight seal.

By using U·S·S 17-TV instead of glass for the conical section of the picture tube, you can cut the weight of this key part over one-third. The result is important savings in handling, shipping and packing costs. The tube can be shipped installed in the receiver with little danger of damage in transit.

In addition to its light weight, other inherent advantages of Stainless make important contributions here. Its strength enables the tube to withstand extreme pressures and reduces breakage hazards. Because glass area is held to a minimum, and

because of the protection provided by the Stainless Steel cone, hazards of implosion are minimized—in tube manufacture, in installation and in service. The U·S·S 17-TV cone permits the use of a flawless, smooth glass face, thus resulting in cleaner, and sharper pictures.

Whether you manufacture or use cathode ray tubes, investigate the possibilities of U·S·S 17-TV Stainless Steel, developed especially for the television industry. Like all other grades of U·S·S Stainless, it is made to give you the finest possible performance.

AMERICAN STEEL & WIRE COMPANY, CLEVELAND · CARNEGIE-ILLINOIS STEEL CORPORATION, PITTSBURGH
 COLUMBIA STEEL COMPANY, SAN FRANCISCO · NATIONAL TUBE COMPANY, PITTSBURGH · TENNESSEE COAL, IRON & RAILROAD COMPANY, BIRMINGHAM
 UNITED STATES STEEL SUPPLY COMPANY, WAREHOUSE DISTRIBUTORS, COAST-TO-COAST · UNITED STATES STEEL EXPORT COMPANY, NEW YORK



U·S·S[®] STAINLESS STEEL

SHEETS · STRIP · PLATES · BARS · BILLETS · PIPE · TUBES · WIRE · SPECIAL SECTIONS

UNITED STATES STEEL

**33 YEARS
OF
EXPERIENCE**

*If there's any
Question
about it...*

COTO-COIL Windings

Can Provide the Answer

Through two world wars and intervening years of peace, Coto-Coil has earned a reputation for windings which conform to specifications with great exactness. Windings which will function under many and severe operating conditions.

We offer engineering ability with a wealth of experience. Our methods are modern... our equipment of latest design.

Coil winding is our business. That's all we have to sell. We'd like to serve you and shall be glad to quote.

COTO-COIL CO., INC.

COIL SPECIALISTS SINCE 1917

65 PAVILION AVE.
PROVIDENCE 5, R.I.



from antenna to director was 0.1 wavelength and from antenna to reflector, 0.15 wavelength. The antenna was 194 inches long, the reflector, 204 inches, and the director, 184 inches. All elements were 1 inch in diameter.

With a series variable capacitor and a Micro-Match, two feed points were located 20 inches each side of center. Type RG-8/U cable was then connected as described. The cross lead was formed by 42 inches of center conductor from which the shield had been removed. The cross lead was allowed to sag about three inches from the center of the antenna. The driven element is diagrammed in Fig. 1.

The inductance of 42 inches of wire with a cross-sectional area approximately equivalent to number 14 wire from Eq. 1 is 1.52 μ h. The inductance of the antenna, L_p is 0.862 μ h. Reactance X_p is therefore 158 ohms at 29 mc. Reactance X_s from Eq. 4 is 19 ohms. Reactance X_e is 277 ohms, making the total inductive reactance 296 ohms.

The capacitive reactance required for resonance is 296 ohms. This capacitive reactance was obtained by a 72-inch length of RG-8/U, shorted at one end, as calculated by Eq. 5.

First tests on the antenna were made with the shield of the capacitive shorted section and the driving cable bonded to the antenna and to the metal supporting pole throughout their mutual lengths. On a second antenna the shields were bonded to the antenna at the driving points where the vinyl jacket was removed from the cable but the remainder of the cable was left with the insulation on and merely taped along the antenna and supporting pole. No difference in performance was detectable in the two systems.

Standing-Wave Ratio

The antenna was mounted one wavelength above ground and tested with a Jones Micro-Match. The standing-wave ratio was measured as 1/1 at 29 mc, the resonant frequency of the antenna, rising to approximately 1.5/1 at 28.5 and 30.0 mc.

A question arises as to the desirability of a resonant system for im-

Your First Choice for Selenium Rectifiers

Federal



To meet the most
exacting requirements
for
**MILITARY END-USE
EQUIPMENT**

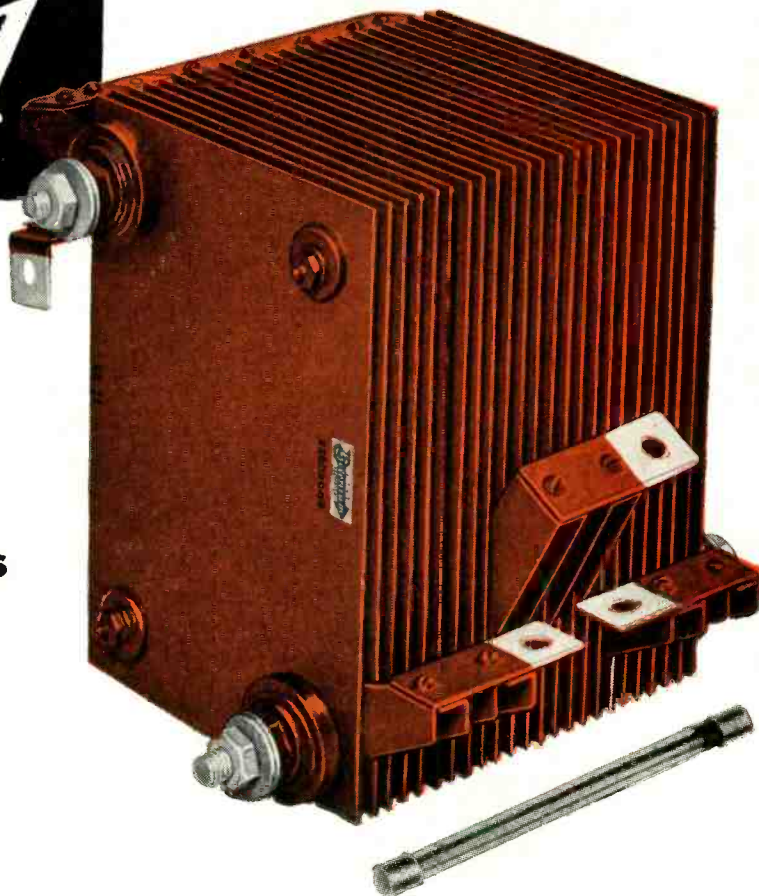

Federal introduced the Selenium Rectifier in this country and has since been **FIRST IN**

- Experience
- Development
- Production
- Performance
- Dependability

Federal Selenium Rectifier stacks are available as components, and in sub-assemblies and complete assemblies.

As America's oldest and largest manufacturer of Selenium Rectifiers, Federal has had unrivaled experience in developing and building Selenium Rectifiers to meet an almost unlimited range of specifications. Millions of Federal Selenium Rectifiers are serving with efficiency, dependability and economy in countless applications... from aircraft to submarines and from subminiature special equipment to heavy duty power supplies.

This Federal background of leadership in the field of Selenium Rectifiers has never been of greater importance than it is today. It is your assurance of obtaining Selenium Rectifiers that adhere to the most rigid requirements for military end-use equipment.

Federal engineers, with their wealth of experience in rectifier design and application, will assist you in determining the proper Selenium Rectifier to meet your power conversion requirements. Address your inquiries to Department F-213.



FEDERAL TELECOMMUNICATION LABORATORIES, Nutley, N. J. . . . a unit of I T & T's world-wide research and engineering organization.

Federal Telephone and Radio Corporation

Selenium-Intelin Division, 100 KINGSLAND ROAD, CLIFTON, NEW JERSEY
In Canada: Federal Electric Manufacturing Company, Ltd., Montreal, P. Q.
Export Distributors: International Standard Electric Corp., 67 Broad St., N. Y.



G.E.'s 9574

all-purpose*

insulating varnish provides

**BETTER BONDING
BETTER PENETRATION
NO SLUDGING**



Mr. Guy W. Probst

That's what Guy W. Probst, owner of the Lockhaven Electric Repair Co., Lockhaven, Pa., says about General Electric's 9574. Here is his statement:

"G-E all-purpose insulating varnish 9574 gives you a cover coat you can see and that fills up between the Formex wires. I've had very good success with it on armatures up to 2000 RPM. On formed coils I can bake before forming and the turns don't come apart when you pull the coil. I've had no trouble with sludging, and all my work is hot dipped. I find that I only use about half as much 1201 Glyptal as a cover coat on 9574 as I had to use over the varnish I had been using, and I get higher gloss and better bonding when 1201 is used over 9574."

**G-E 9574 gives excellent results on all types of coils except extra-high-speed armatures. It is one of G.E.'s complete line of electrical insulating materials, including adhesives, wedges, cements, compounds, cords and twines, sleeving, wire enamels, mica, papers and fibers, permafilts, tapes, tubing, varnished cloths, varnishes.*

You can put your confidence in

GENERAL  ELECTRIC

CD50-K2



EASY TO USE

BAKES AT LOWER TEMPERATURES than is possible with most other synthetic varnishes.

PENETRATES EASILY into the deepest coils.

NO SPECIAL THINNER required (just petroleum spirits).

STABLE—will not tend to harden in the tank.

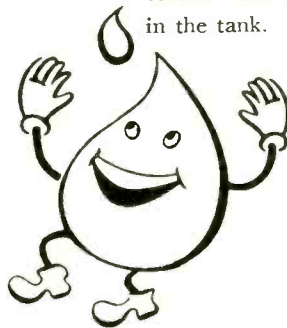

SEND FOR BULLETIN!

If you haven't yet tried G-E 9574, get in touch with your local G-E Distributor, or write for our new bulletin to Section K-2, Chemical Department, General Electric Company, Pittsfield, Mass.



POPULATION - 0

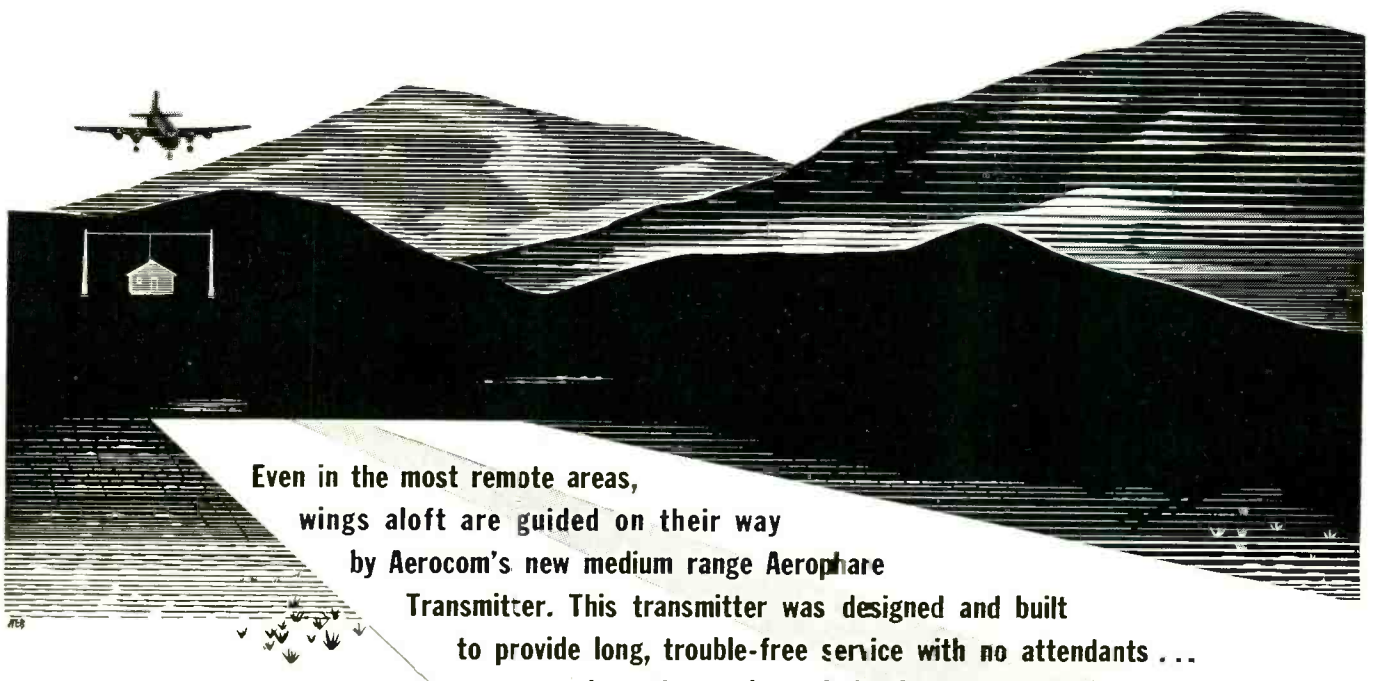

Even in the most remote areas,
wings aloft are guided on their way
by Aerocom's new medium range Aerophare
Transmitter. This transmitter was designed and built
to provide long, trouble-free service with no attendants ...
even where the total population is Zero.

AEROCOM'S Dual Automatic Package-Type Radio Beacon

for completely unattended service. This aerophare (illustrated) consists of two 100 watt (or 50 watt) transmitters, one AK-3B keyer, one ACA automatic transfer, and an antenna tuner. (Power needed 110 volt or 220 volt - 50/60 cycles)

Frequency range 200 - 415 Kcs.: self-contained P. A. coil covers entire range; 1 "plug-in" crystal oscillator coil covers 200 - 290 Kcs., other 290 - 415 Kcs. (Self-excited oscillator coils covering same ranges are available). High level plate modulation of final amplifier is used, giving 35% tone modulation in 100 watt transmitter and 35-50% in 50 watt model. Microphone P-T Switch when depressed interrupts tone, permitting voice operation.

Using 866A rectifiers, unit can be operated in air temperature range 0°C to +45°C; using 3B25 rectifiers, -35°C to +45°C; humidity up to 95%.

Aerocom's Automatic Transfer unit will place the "stand-by" transmitter in operation when main transmitter suffers loss (or low level) of carrier power or modulation. The characteristics of the keyed call letters are so modified on "stand-by" that a distant monitoring station can determine whether the main or "stand-by" transmitter is operating.

Unit is ruggedly constructed and conservatively rated, providing low operating and maintenance costs. Engineering data on this unit and other Aerocom communications products are available on request.

CONSULTANTS, DESIGNERS AND MANUFACTURERS OF STANDARD OR SPECIAL
ELECTRONIC, METEOROLOGICAL AND COMMUNICATIONS EQUIPMENT

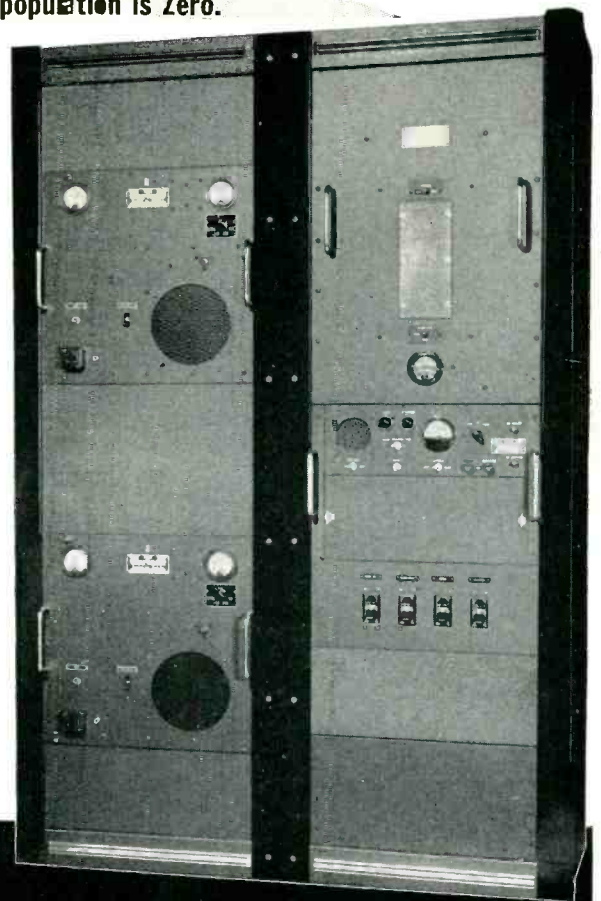

AER - O - COM

Reg. U. S. Pat. Off.

AERONAUTICAL COMMUNICATIONS EQUIPMENT, INC.
3090 Douglas Road, Miami 33, Florida

pedance matching such as the length of coaxial cable used to produce capacitive reactance. Reference to Fig. 2C shows that the series resonant circuit includes a resistance of 51.5 ohms. The total series inductive reactance has been calculated as 296 ohms. Thus, the Q of the series circuit is 5.75. Obviously, the feed system is a wide-band device compared to the three-element parasitic array on which it is used.

The 29-mc beam antenna was next checked for line current balance. The pattern of the antenna was first measured with a field-strength meter. Maximum radiation was found to be perpendicular to the antenna elements. An unbalanced antenna will usually show an altered pattern with the maxima occurring slightly off center. The field-strength meter was then positioned a fixed distance from each antenna-element tip in turn and the deflection of the meter was found to be the same in each case. This test indicates that the voltage at each antenna tip is the same. Small incandescent bulbs hung from each end of the antenna showed the same brilliance.

Further Tests

Next, the center conductor was broken close to the first driving point where the conductor emerged from the shield. A receiver connected to the line was now completely dead. The absence of pickup showed that the cable had no signal pickup of its own. Type RG-8/U cable may be used to carry transmitter outputs of two kw or so with the line matched. A standing wave exists in the capacitive shorted line section. Therefore care must be used to select a line of sufficient insulation capacity. For a one-kilowatt transmitter the line current which must flow through the matching section is 4.41 amperes.

The voltage drop across the capacitive section of coax is 1,310 volts. This voltage appears between the inner conductor and the shield of the capacitive matching section at the point where the inner conductor enters the shield. Since RG-8/U has a maximum voltage rating of 4,000 volts rms, it should

specify



"NOFLAME-COR"

the TELEVISION hookup wire

APPROVED BY
UNDERWRITERS
LABORATORIES AT

90°
CENTIGRADE — 600 VOLTS

Proven BEST, and specified regularly, by leading manufacturers of television, F-M, quality radio and all exacting electronic equipment. For maximum output and minimum rejects. Available in all sizes, solid and stranded. Over 200 color combinations.

PRODUCTION ENGINEERS: Specify "NOFLAME-COR" for absolute uniformity of diameter, permitting clean stripping of insulation without damage to the copper conductor...

NO NICKING OF CONDUCTORS
NO CONSTANT RESETTING OF BLADES

AVOID LOSSES FROM
"BLOBBING"
Not being an extruded plastic,
eliminates the costly "blobbing" of
insulations under soldering heat

- Flame Resistant
- High Insulation Resistance
- Heat Resistant
- Facilitates Positive Soldering
- High Dielectric
- Easy Stripping
- Also unaffected by the heat of impregnation — therefore, ideal for coil and transformer leads

COMPLETE DATA AND SAMPLES ON REQUEST

"made by engineers for engineers"

CORNISH WIRE COMPANY, Inc.

605 North Michigan Avenue,
Chicago 11

15 Park Row, New York 7, N. Y.

1237 Public Ledger Bldg.,
Philadelphia 6

MANUFACTURERS OF QUALITY WIRES AND CABLES FOR THE ELECTRICAL AND ELECTRONIC INDUSTRIES

In this panel are illustrated standard models of HELIPOT multi-turn and single-turn precision potentiometers—available in a wide range of resistances and accuracies to fulfill the needs of nearly any potentiometer application. The Beckman DUODIAL is furnished in two designs and four turns-ratios, to add to the usefulness of the HELIPOT by permitting easy and rapid reading or adjustment.

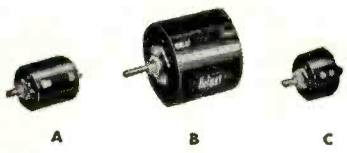

MODELS A, B, & C HELIPOTS
 A—10 turns, 46" coil, 1-13/16" dia., 5 watts—resistances from 10 to 300,000 ohms.
 B—15 turns, 140" coil, 3-5/16" dia., 10 watts—resistances from 50 to 500,000 ohms.
 C—3 turns, 13-1/2" coil, 1-13/16" dia., 3 watts—resistances from 5 to 50,000 ohms.



MODELS D AND E HELIPOTS
 Provide extreme accuracy of control and adjustment, with 9,000 and 14,400 degrees of shaft rotation.
 D—25 turns, 234" coil, 3-5/16" dia., 15 watts—resistances from 100 to 750,000 ohms.
 E—40 turns, 373" coil, 3-5/16" dia., 20 watts—resistances from 200 ohms to one megohm.



MODELS F AND G PRECISION SINGLE-TURN POTENTIOMETERS
 Feature both continuous and limited mechanical rotation, with maximum effective electrical rotation. Versatility of designs permit a wide variety of special features.
 F—3-5/16" dia., 5 watts, electrical rotation 359°—resistances 10 to 100,000 ohms.
 G—1-5/16" dia., 2 watts, electrical rotation 356°—resistances 5 to 20,000 ohms.

LABORATORY MODEL HELIPOT
 The ideal resistance unit for use in laboratory and experimental applications. Also helpful in calibrating and checking test equipment. Combines high accuracy and wide range of 10-turn HELIPOT with precision adjustability of DUODIAL. Available in eight stock resistance values from 100 to 100,000 ohms, and other values on special order.



MODELS R AND W DUODIALS
 Each model available in standard turns-ratios of 10, 15, 25 and 40 to 1. Inner scale indicates angular position of HELIPOT sliding contact, and outer scale the helical turn on which it is located. Can be driven from knob or shaft end.
 R—2" diameter, exclusive of index.
 W—4-3/4" diameter, exclusive of index. Features finger hole in knob to speed rotation.

FOR PRECISION POTENTIOMETERS come to Helipot

For many years The HELIPOT Corporation has been a leader in the development of advanced types of potentiometers. It pioneered the *helical* potentiometer—the potentiometer now so widely used in computer circuits, radar equipment, aviation devices and other military and industrial applications. It pioneered the DUODIAL®—the turns-indicating dial that greatly simplifies the control of multiple-turn potentiometers and other similar devices. And it has also pioneered in the development of many other unique potentiometric advancements where highest skill coupled with ability to mass-produce to close tolerances have been imperative.

In order to meet rigid government specifications on these developments—and at the same time produce them economically—HELIPOT® has perfected unique manufacturing facilities, including high speed machines capable of winding extreme lengths of resistance elements employing wire even less than .001" diameter. These winding machines are further supplemented by special testing facilities and potentiometer "know-how" unsurpassed in the industry.

So if you have a problem requiring *precision potentiometers* your best bet is to bring it to The HELIPOT Corporation. A call or letter outlining your problem will receive immediate attention!

*Trade Marks Registered

The versatility of the potentiometer designs illustrated above permit a wide variety of modifications and features, including double shaft extensions, ganged assemblies, the addition of a multiplicity of taps, variation of both electrical and mechanical rotation, special shafts and mounting bushings, high and low temperature operation, and close tolerances on both resistance and linearity. Examples of potentiometers modified for unusual applications are pictured at right.

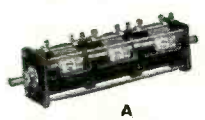

3-GANGED MODEL A HELIPOT AND DOUBLE SHAFT MODEL C HELIPOT
 All HELIPOTS, and the Model F Potentiometer, can be furnished with shaft extensions and mounting bushings at each end to facilitate coupling to other equipment. The Model F, and the A, B, and C HELIPOTS are available in multiple assemblies, ganged at the factory on common shafts, for the control of associated circuits.

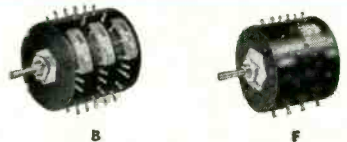

MULTITAPPED MODEL B HELIPOT AND 6-GANGED TAPPED MODEL F
 This Model B Helipot contains 40 taps, placed as required at specified points on coil. The Six-Gang Model F Potentiometer contains 19 additional taps on the middle two sections. Such taps permit use of padding resistors to create desired non-linear potentiometer functions, with advantage of flexibility, in that curves can be altered as required.

THE Helipot CORPORATION, SOUTH PASADENA 2, CALIFORNIA

Maximum Reliability Every Time with AIRPAX CHOPPERS

now . . . the A586



60 CYCLE CHOPPER

Precision engineered
for reliability . . .

for amplification of low level DC signals . . . The
A586 is supplied hermetically sealed . . . almost un-
affected by shock, vibration, temperature extremes.



1024 GREENMOUNT AVE.

BALTIMORE 2, MARYLAND

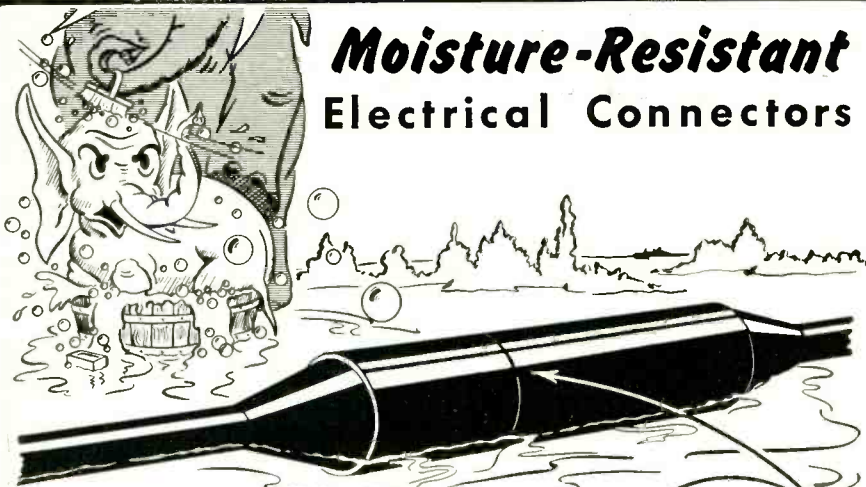

Moisture-Resistant Electrical Connectors

No question about it . . . JOY plugs and sockets are today's out-
standing electrical connector value! Molded as one-piece Neoprene
units and factory vulcanized to cords, they won't crack or shatter
under hard blows — are surprisingly immune to climatic changes —
and are trim, safe and easy to handle. Whenever advantageous,
JOY Connectors are equipped with the famous MINES "Water-
Sealing" face. Cut-away illustration in circle shows how close fit-
ting segments on mating Male and Female plugs positively "Seal-
out" dirt and moisture by enclosing contacts in a resilient rubber
housing. Ask for a complete description on this and other advan-
tages that only JOY Connectors provide.

A wide variety of sizes, shapes and pin combinations are available to
meet the portable power requirements of TV, FM, AM or PA Circuits.
Illustrations show JOY'S No. 2C156M Portable Male Plug and No.
2C156F Portable Female.

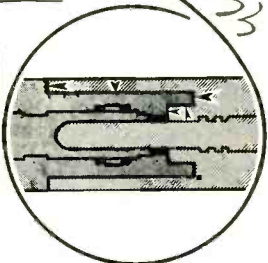

MALE & FEMALE PLUG ENGAGED
Note 5-way WATER-SEAL (arrows)

ME-150.3

MINES EQUIPMENT — MINES — Division

JOY MANUFACTURING COMPANY

HENRY W. OLIVER BLDG., PITTSBURGH 22, PENNA.

PHYSICISTS

And

SENIOR RESEARCH ENGINEERS

. . .

POSITIONS NOW OPEN

. . .

Senior Engineers and Physi-
cists having outstanding
academic background and
experience in the fields of:

- Microwave Techniques
- Moving Target Indication
- Servomechanisms
- Applied Physics
- Gyroscopic Equipment
- Optical Equipment
- Computers
- Pulse Techniques
- Radar
- Fire Control
- Circuit Analysis
- Autopilot Design
- Applied Mathematics
- Electronic
Subminiaturization
- Instrument Design
- Automatic Production
Equipment
- Test Equipment
- Electronic Design
- Flight Test
Instrumentation

are offered excellent work-
ing conditions and opportuni-
ties for advancement in our
Aerophysics Laboratory.
Salaries are commensurate
with ability, experience and
background. Send informa-
tion as to age, education,
experience and work prefer-
ence to:

NORTH AMERICAN AVIATION, INC.

Aerophysics Laboratory

Box No. K-4, 12214 S. Lakewood Blvd.

DOWNEY, CALIFORNIA

Saving energy for better low-cost telephone service



Arrow points to tube containing a wire specimen under test for surface conductivity. The tube and wire are excited to resonance by microwaves from generator at extreme left. Conductivity is calculated from frequency values indicated by barrel-shaped wavemeter (top center) and resonance curves traced on an oscilloscope screen (not shown).

In the waveguides which conduct microwaves to and from the antennas of radio relay systems, current is concentrated in a surface layer less than 1/10,000 inch thick, on the inner surface of the waveguide. When these surfaces conduct poorly, energy is lost.

To investigate, Bell radio scientists devised exact methods to explore this skin effect at microwave frequencies.

Scratches and corrosion, they found, increase losses by 50 per cent or more. Even silver plating, smooth to the eye,

can more than double the losses of a polished metal. Very smooth conductors, like electropolished copper, are best. An inexpensive coat of clear lacquer preserves initial high conductivity for many months.

Energy saved *inside* a microwave station is available for use in the radio-relay path *outside*. So stations can sometimes be spaced farther apart, and there will always be more of a margin against fading. Here is another example of the practical value of research at Bell Telephone Laboratories.

BELL TELEPHONE LABORATORIES



WORKING CONTINUALLY TO KEEP YOUR TELEPHONE SERVICE BIG IN VALUE AND LOW IN COST

NEW **SNAP** Acting STEVENS THERMOSTATS

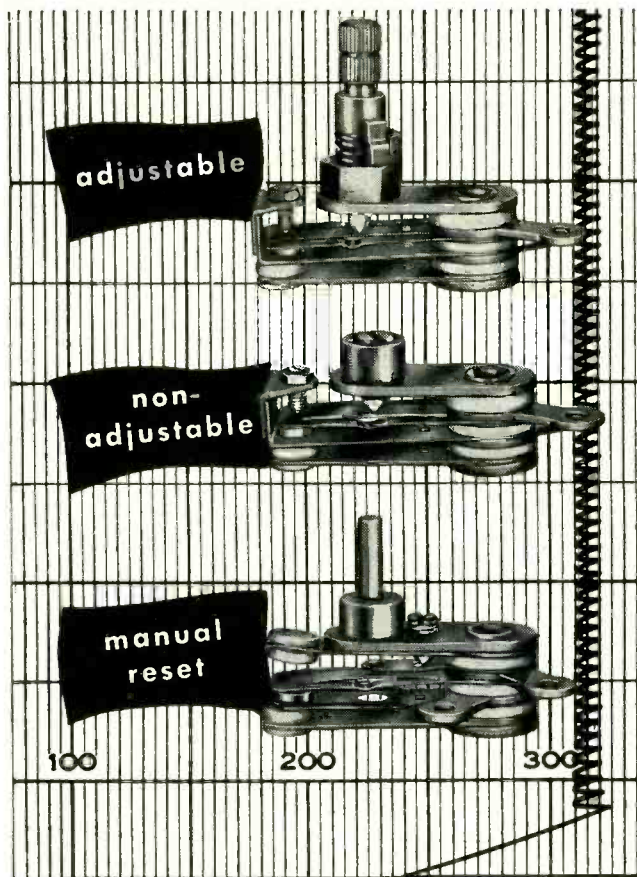

- narrow differentials, as low as 5° F
- highly responsive
- stud mounting

Now — for the *first time* — small, snap-acting thermostats in adjustable, non-adjustable or manual reset styles are available to manufacturers of devices requiring sensitive, precise control of high-wattage heater loads.

These *new* Stevens thermostats feature an electrically independent bi-metal element in close contact with mounting base. Thus, thermostat closely follows temperature of controlled device and bi-metal responds rapidly to temperature changes. Contact pressure is positive until the actual instant the contacts snap open.

Interchangeable with Stevens Type S units, the new Stevens thermostats insure satisfactory performance for your appliances and industrial apparatus. Always specify Stevens thermostats — they *perform better . . . last longer.*

A-3366

STEVENS manufacturing company, inc.
MANSFIELD, OHIO

be adequate for transmitter powers of well over one kilowatt.

REFERENCES

- (1) King, Wing and Mimno, "Transmission Lines, Antennas and Wave Guides" p 145, First Edition, McGraw-Hill, New York.
- (2) King, Wing, Mimno, "Transmission Lines, Antennas and Wave Guides", p 158, First Edition, McGraw-Hill, New York.
- (3) E. K. Sandeman, "Radio Engineering" 1, p 687, John Wiley & Sons, New York 1948.
- (4) F. E. Terman, "Radio Engineers Handbook," p 48, First Edition, McGraw-Hill, New York.

British Developments in Instrumentation

BY JOHN H. JUPE
Middlesex, England

A REVIEW of recent developments in Britain discloses some novel applications of electron tubes at work, particularly in the field of scientific instrumentation.

It is sometimes required to know the size of carbon particles in luminous flames. A particle size meter has been developed by the British Iron and Steel Research Association to do this efficiently.

The instrument uses an interrupted parallel beam of ultraviolet light which is allowed to impinge on the region of the flame under examination. The cloud of luminous carbon particles in the flame will scatter the ultraviolet light which is then detected by a multiplier-type photoelectric cell and a-c amplifier. A small monochromator is interposed to select the light falling onto the photocell. By making the wavelength of the light comparable with the size of the particles, the character of the scattering is very dependent on the size, which can thus be measured in terms of the amplified photocell current.

Midget Magnetometer

It has been known for a long time that if the metal germanium is prepared with a sufficient degree of purity it exhibits a pronounced Hall effect, its electrical resistance is a measure of the magnetic field in which the metal is placed. This effect has now been used as a basis of simple, self-contained instru-

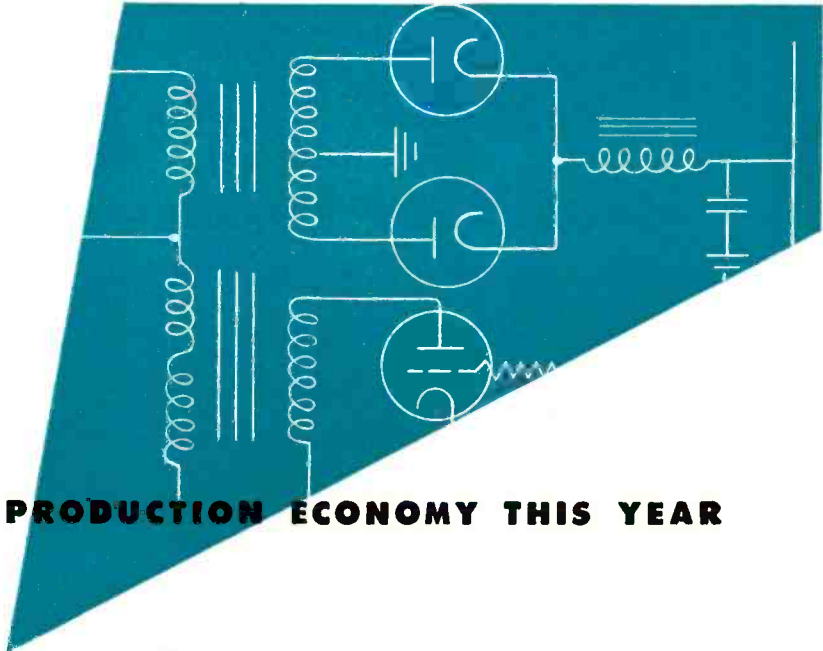

DESIGN FOR TRUE PRODUCTION ECONOMY THIS YEAR

WITH **Transformers**

BUILT TO MEET YOUR EXACT REQUIREMENTS

We have specialized knowledge, skill and a full range of facilities for mass-produced economical units and hermetically sealed transformers of all types, as well as for large single and 3-phase transformers.

For a superior product, priced competitively . . . for assured efficiency and long service life, let **FERRANTI** build transformers to your precise needs.

CHECK YOUR REQUIREMENTS

Power and Rectifier Transformers up to 50 KVA (High Voltage or High Current) . . . Saturable Reactors . . . Special Cores and High Temperature Insulation . . . Class B Hermetically sealed Types.



Television Transformers . . . Control Transformers . . . Audio Transformers . . . Power and Audio Filter Chokes

We invite your inquiries

Ferranti Electric, Inc.

30 ROCKEFELLER PLAZA, NEW YORK 20, NEW YORK

S.S. White MOLDED RESISTORS



Of particular interest to all who need resistors with inherent low noise level and good stability in all climates



TYPE 65X

Actual Size

STANDARD RANGE

1000 OHMS TO 9 MEGOHMS

Used extensively in commercial equipment including radio, telephone, telegraph, sound pictures, television, etc. Also in a variety of U. S. Navy equipment.

HIGH VALUE RANGE

10 to 10,000,000 MEGOHMS

This unusual range of high value resistors was developed to meet the needs of scientific and industrial control, measuring and laboratory equipment — and of high voltage applications.

SEND FOR BULLETIN 4906

It gives details of both the Standard and High Value resistors, including construction, characteristics, dimensions, etc. Copy with Price List mailed on request.



THE S.S. White INDUSTRIAL DIVISION
DENTAL MFG. CO. Dept. R 10 East 40th St. NEW YORK 16, N. Y.



What to expect from

ATOM BOMB EXPLOSION

Here is a timely survey, prepared under the direction of the Los Alamos Scientific Laboratory, that presents the results to be expected from the detonation of atomic weapons. This book gives every technically interested person—municipal authorities, civil and utility engineers, etc.—an understanding of the effects of this enormous energy release when used as a weapon in war, as a basis for the development and administration of protective measures. It gives the principles and description of atomic explosion, and discusses physical damage (from air blast, ground, and underwater shock), decontamination, and effects on personnel.

Today's key to protective measures for personnel and property

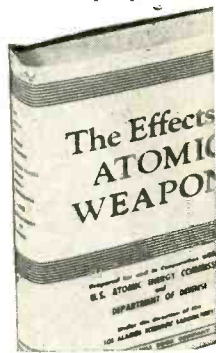

Commended by the Civil Defense Office, National Security Resources Board.

Just Out

THE EFFECTS OF ATOMIC WEAPONS

456 pages, \$3.00

The book's detail descriptions of the physical phenomena associated with atomic explosions provides valuable basic data helpful in the preparation of practical plans for atomic warfare defenses. To help you better understand the effects of atomic weapons, you are given vital information on thermal radiation and incendiary effects — initial nuclear radiations and the protection of personnel. You will also find an approximate method of computing the deformation of structure by a blast wave, and pertinent information on the calculation of hazard from world-wide contamination. The predictions in this book represent the most nearly quantitative approach to atomic bomb phenomenology which can be published at this time.

Prepared for and in Cooperation with the U. S. ATOMIC ENERGY COMMISSION and DEPARTMENT OF DEFENSE

Examine the book 10 days FREE

McGRAW-HILL BOOK COMPANY
330 W. 42d St., NYC 18

Send me a copy of THE EFFECTS OF ATOMIC WEAPONS for 10 days' examination on approval. In 10 days I will remit \$3.00, plus a few cents for delivery, or return the book. (We pay for delivery if you remit with this coupon. Same return privilege.)

Name

Address

City Zone State

Company

Position L-10-50

Books sent on approval in U. S. and Canada only

COSSOR for QUALITY

Unique twin beam flat face tube permits EXACT time comparison of two waveforms without phase or frequency error. Beams are independent vertically and locked in horizontal direction, can be separated, superimposed or crossed for any comparative test . . . and . . .

Model 1035 TWIN BEAM SCOPE (illustrated) offers these additional features:

DIRECT time measurement on calibrated controls from 150 millise. to 1 microsec.

DIRECT voltage measurement on each beam from 500 volts to 1 millivolt. Recurrent or triggered sweeps from 150 millise. to 5 microsec. High gain, wideband amplifier,—3 de. at 7 Mc.

Write for details on Model 1428 Scope Camera for still or moving film records.

All instruments and spares in stock New York.

WHEN TIMING COUNTS you can count on Cossor Twin Beam Scopes

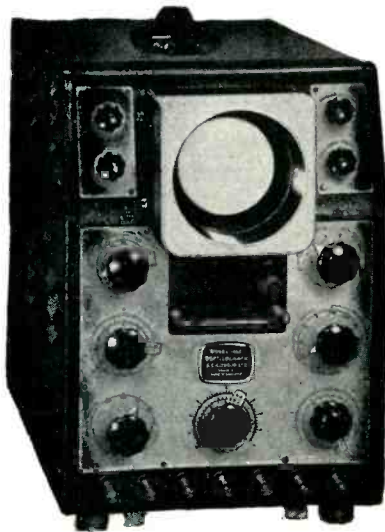

\$465 fob Halifax
\$650 fob New York

COSSOR (CANADA) LIMITED

301-303 Windsor Street, Halifax, N. S.

BEAM INSTRUMENTS CORPORATION

Room 907, 511 5th Avenue, New York 17, N. Y.

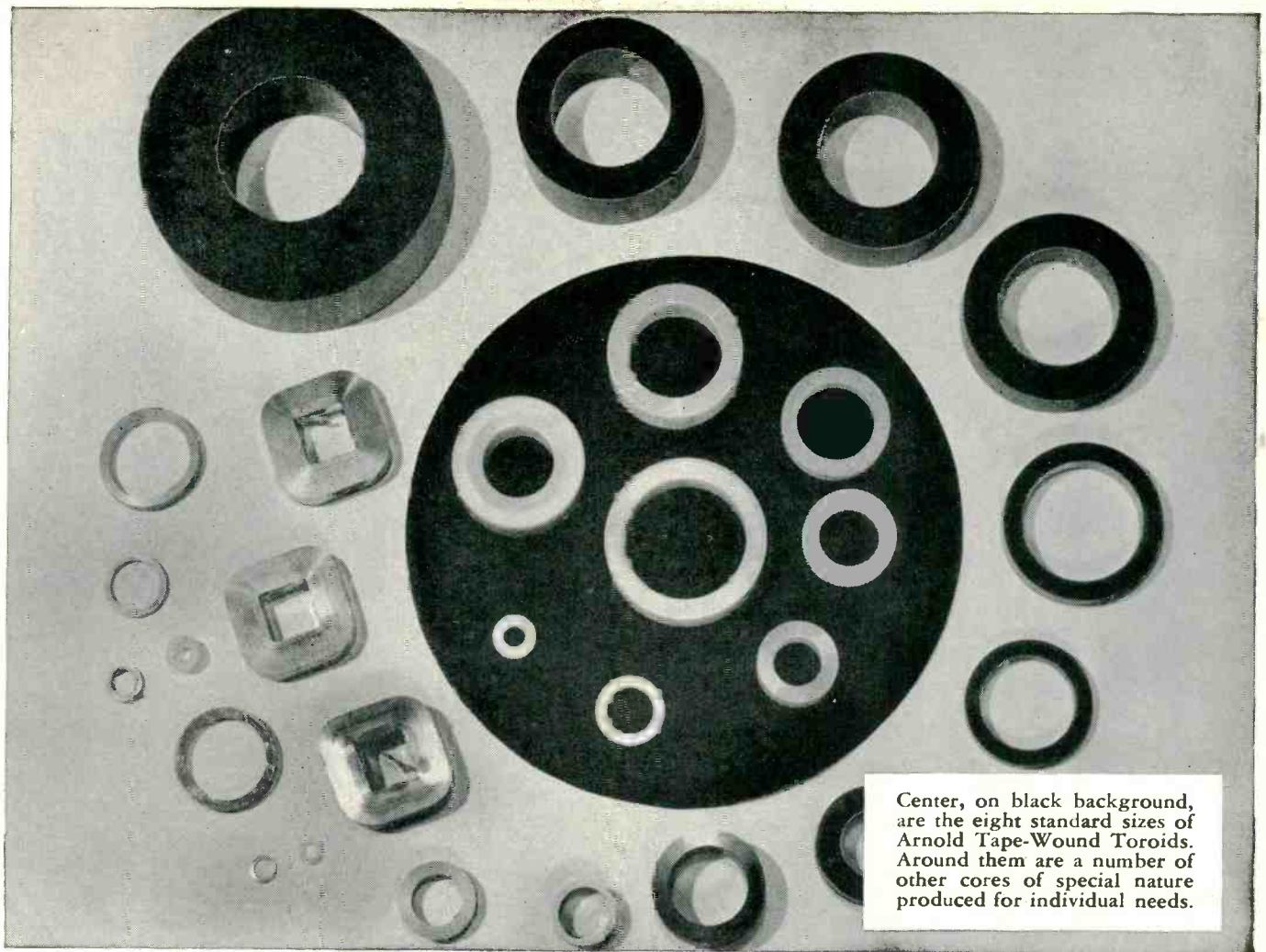

Center, on black background, are the eight standard sizes of Arnold Tape-Wound Toroids. Around them are a number of other cores of special nature produced for individual needs.

ARNOLD TAPE-WOUND TOROIDAL CORES

of DELTAMAX
4-79 MO-PERMALLOY
SUPERMALLOY*

APPLICATIONS

MAGNETIC AMPLIFIERS
PULSE TRANSFORMERS
NON-LINEAR RETARD COILS
and TRANSFORMERS
PEAKING STRIPS, and many other
specialized applications.

RANGE OF SIZES

Arnold Tape-Wound Toroids are available in eight sizes of standard cores—all furnished encased in molded nylon containers, and ranging in size from 1/2" to 2 1/2" I.D., 3/4" to 3" O.D., and 1/8" to 1/2" high.

RANGE OF TYPES

These standard core sizes are available in each of the three magnetic materials named, made from either .004", .002" or .001" tape, as required.

In addition to the standard toroids described at left, Arnold Tape-Wound Cores are available in special sizes manufactured to meet your requirements—toroidal, rectangular or square. Toroidal cores are supplied in protective cases.

*Manufactured under licensing arrangements with Western Electric Company.

W&D 3182

THE ARNOLD ENGINEERING COMPANY



SUBSIDIARY OF ALLEGHENY LUDLUM STEEL CORPORATION

General Office & Plant: Marengo, Illinois

Thinking of
Stainless?



Think
of **ALLMETAL**
for the finest in
**STAINLESS
STEEL
FASTENERS**

MADE RIGHT —

By specialists in stainless steel since 1929.

PRICED RIGHT —

Because ALLMETAL uses modern equipment—including cold-heading machines—devoted solely to stainless.

RIGHT COMBINATION

For solving fastening problems quickly, economically.

Allmetal has the fasteners you want. Stock items, including Government and "AN" specs, shipped immediately. Prompt delivery on various types of Phillips Recessed Head screws and specials. Switch to Allmetal Stainless Fasteners when you switch to Stainless!

Use our "Rush Order" direct wire service—Send telegrams to "Allmetal Screw Products—WUX—New York."—that's all—

WRITE FOR CATALOG 49C

MANUFACTURERS SINCE 1929

ALLMETAL

Screw Products Co., Inc.

33 GREENE STREET, NEW YORK 13, N. Y.

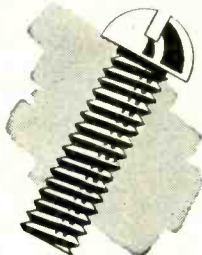
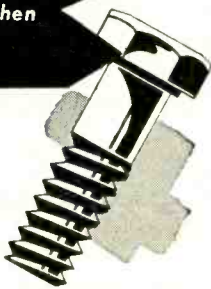

Audio fidelity of a television receiver is tested in the echo-free room built by General Electric Co. Ltd. of England

ments for measuring and exploring magnetic fields.

A small flake of germanium $\frac{1}{8} \times \frac{1}{8} \times 0.015$ -inch in thickness is mounted in a probe and is thus capable of being used to measure field strengths in very small gaps. This instrument has an overall range of 0 to 25,000 gauss, in three ranges and has a direct-reading microammeter indicator.

A recent pyrometer development for use at temperatures above 750 C consists of a back-silvered, heat-resisting glass hemisphere. This is so made that black-body radiation can pass out through a small un-silvered hole at the top of the hemisphere, while radiations of wavelength longer than 2.5μ are absorbed by the glass. This prevents reflected radiation from interfering with the heat loss from the surface. A calibrated photocell with a very quick response, an alkali-metal cell, is placed behind the un-silvered hole and the cell current will then be a measure of the true temperature of the surface under examination.

Echo-Free Room

A piece of equipment which has many uses in the electronic and other electrical fields, as well as in mechanical engineering, is an echo-free room.

Such a room has recently been installed by engineers of the General

compare the speed, economy, accuracy of product marking by **E-Z CODE**



E-Z CODES are applied with finger-tip pressure, without moistening. They stick permanently... will not pop, peel or curl even in extremes of heat and humidity... or when pulled through conduit. E-Z Codes provide the fastest, most accurate and inexpensive method of wire marking.

E-Z CODE PIPE, CABLE AND CONDUIT MARKERS provide a fast, accurate method of identifying pipe, cable and conduit lines at a fraction of the cost of painting or other methods. Self-adhesive strips in standard wording, or printed to your specifications, may be applied without moistening by inexperienced help in a few seconds. They last indefinitely.

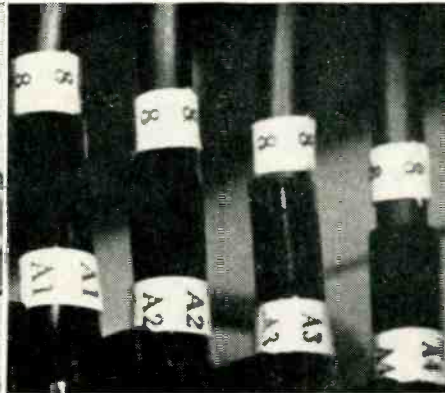

E-Z CODES make even the most complicated wiring circuit an open book to even "green" employees. They eliminate the need for large inventories of colored wire and speed assembly time. They insure accuracy, eliminate mistakes and save costly service calls. E-Z Codes are the proved method of increasing production with new employees without error and mistakes.

USE THESE for inspection or rejection, instruction or warning labels in production, repair or service work. Westline pressure-sensitive labels are applied without moistening. They will not pop, peel or curl even under extremes of heat and humidity... yet are easily peeled off without harming surface.



EXCLUSIVE SPEED TAB permits peeling any marker from the card, while the rest remain protected and ready for instant use. Only the end of the marker needed is exposed, which means less marker spoilage. Speed Tab also protects each marker from grease and dirt found on all workmen's hands. The adhesive thus remains clean giving a firm grip where you want it, on the marker end.

WESTLINE SELF-BACKING, pressure sensitive tape on either cellophane, acetate film, paper or cloth stock can be furnished plain or printed with your message, and in size required. Widths from 1/4" to 3". Lengths from 648" to 2592". Ideal for advertising or production installation and service data. Apply without moistening. They stick until time for removal.

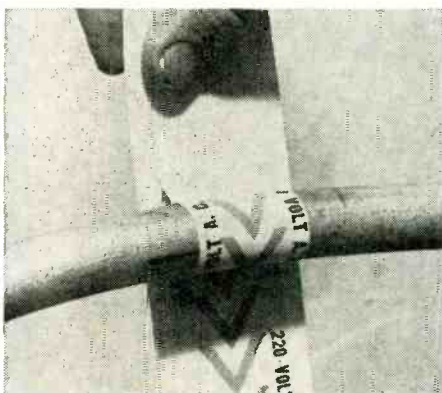

**FREE SAMPLES
SEND FOR COMPLETE
INFORMATION AND SAMPLES...
MAIL THIS COUPON TODAY!**

**E-Z CODE - Westline Products Division • Western Lithograph Company
600 East 2nd Street, Los Angeles, California, Dept. E-11**

Gentlemen: Please send me information and samples of:

- E-Z Code Wire Markers E-Z Code Pipe, Cable & Conduit Markers
 Westline Peelable Labels Westline Self-Adhesive Roll Tape

NAME _____
TITLE _____
COMPANY _____
ADDRESS _____
CITY _____ STATE _____

PATTON-MacGUYER

PRECISE METHODS

SMALL METAL STAMPINGS

In Accordance With Your Prints

Extensive modern plant, complete equipment, engineering and toolmaking skill for producing your stamped metal parts accurately, economically, promptly. Moderate die charges. Facilities for large volume production. We welcome stamping problems.

TERMINALS for ELECTRIC WIRES

Specialists in the terminal field, we have dies to produce over 400 different kinds of separate terminals. Every modern facility to meet your standard or special requirements.

PATTON-MacGUYER COMPANY
Edgewood Station Providence 5, R.I.

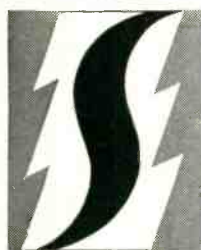

SPECIALTY OFFERS

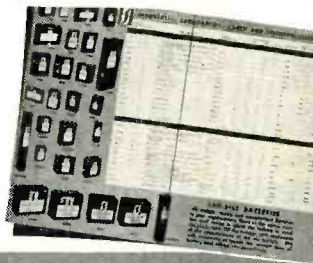

LAB-BILT DRY BATTERIES

Standard or Custom-made



INDUSTRY

LABORATORY



RADIO AND
IGNITION



Write for FREE CATALOG

This catalog gives complete specifications of 78 Lab-Bilt Batteries of industrial and hard-to-get types.

CUSTOM-MADE BATTERIES

Battery Specification Sheet illustrated in catalog enables you to get any type dry battery designed and made to your individual specifications — even in small quantities!

SUPER SERVICE

Specialty Battery Company is specially equipped to make all Lab-Bilt Batteries FRESH for each order and ship immediately. Give your customers this valuable service. Write for a new catalog today.

SPECIALTY BATTERY COMPANY

A Subsidiary of the

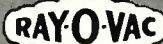

Ray-O-Vac Company

MADISON 10, WISCONSIN

CENTRALINE

ENGINEERED PAPERS

made exactly to
your requirements

for every
electrical need

Armature Papers — Strong kraft with high dielectric strength and anti-corrosion properties.

Cable Wrap — Flat or creped kraft; can be waterproofed or made anti-corrosive as required.

Core Base Paper — Controlled conductivity; free from harmful chemical action.

Insulation Paper — High physical strength, high dielectric strength.

Anti-Rust Papers — Treated to prevent rusting of metals with which it is in contact.

Anti-Corrosive Papers — Chemical properties carefully controlled to assure neutrality.

Centraline Engineered Papers for the Electrical Industry are made especially for your particular purpose. Central laboratories maintain a close check on all manufacturing operations to make sure that every run meets the users specifications. Central engineers are always at your service to aid in the development of new papers or to suggest the use of existing papers that will improve your product, make manufacturing easier or reduce costs. When you need paper, call Central.



REG. U. S. PAT. OFF.

CENTRAL PAPER COMPANY

INCORPORATED

2442 LAKESHORE DRIVE • MUSKEGON, MICH.

BRANCHES IN LEADING CITIES

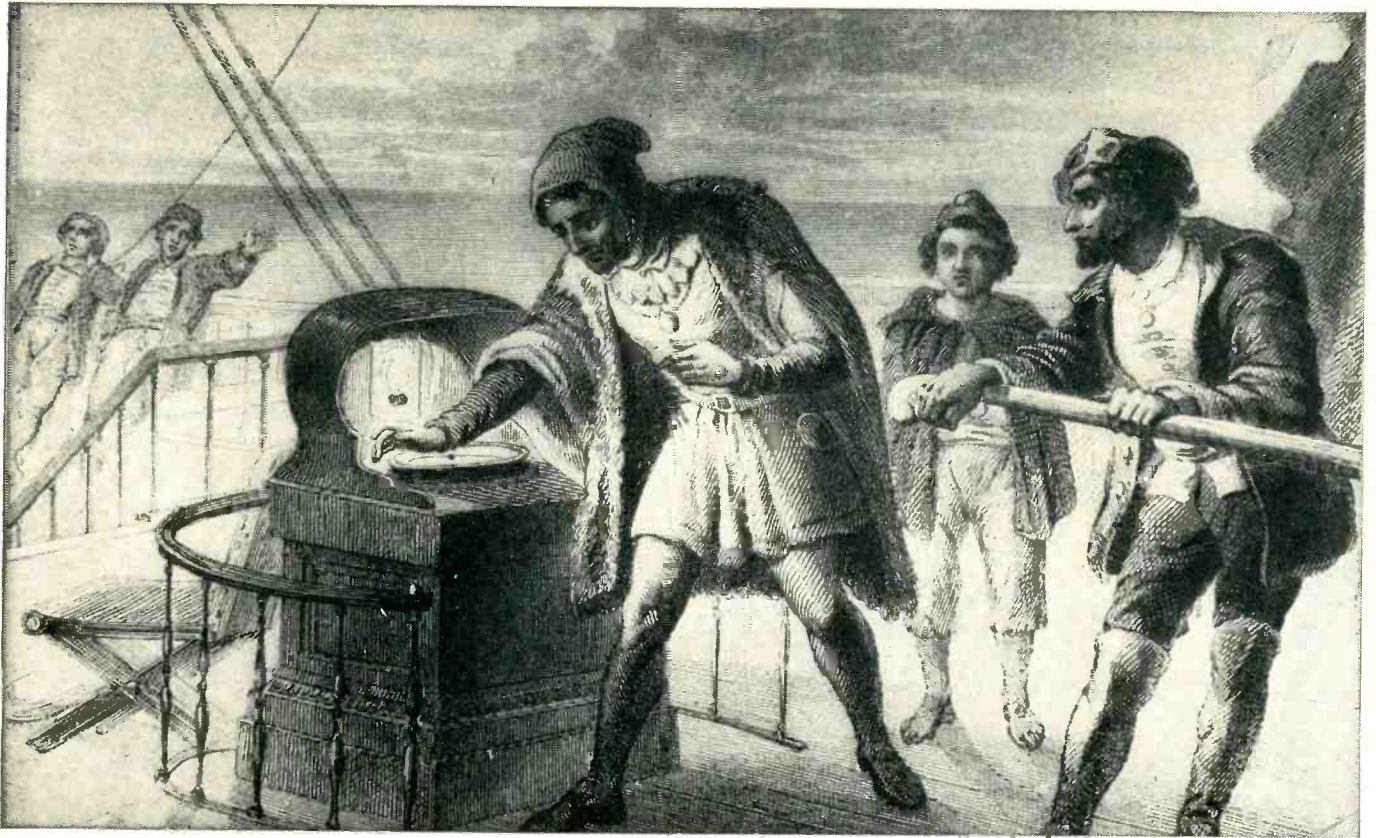

BETTMANN ARCHIVE

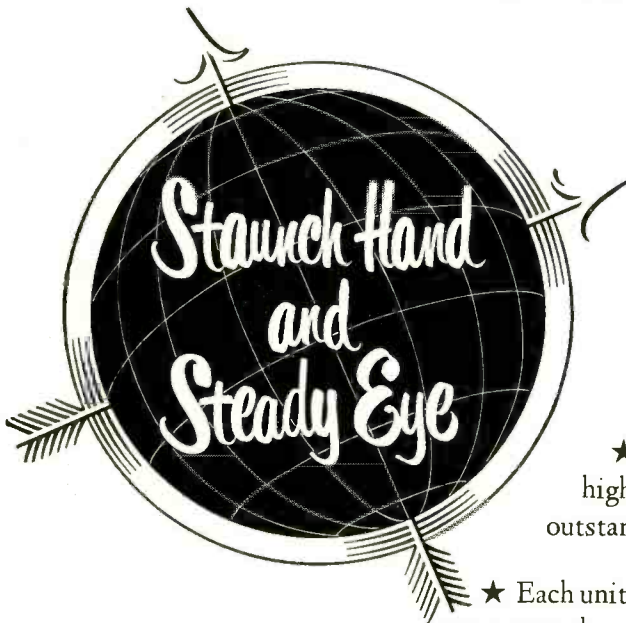

... the prime requisites and the mark of the master pilot throughout the ages.

But no hand, however staunch, no eye, however steady, could master the modern high-speed aircraft without aid from its complex instrumentation and control systems. These are the systems that strengthen the pilot's hand a hundred-fold . . . that present to his watchful eye, instantly and accurately, his progress in flight.

★ And the heart of these systems is frequently a small, high-precision electric motor produced by Kollsman engineers—outstanding specialists in the field.

★ Each unit in Kollsman's line of miniature special purpose motors represents the solution to a particular control problem. Each one has been engineered to provide specific performance characteristics, with the same high degree of precision for which Kollsman instruments and optics are known.

★ The skill and experience of Kollsman engineers are available to you in the solution of your instrumentation and control problems. Address: Kollsman Instrument Division, Square D Company, 80-08 45th Avenue, Elmhurst, N. Y.

KOLLSMAN INSTRUMENT DIVISION

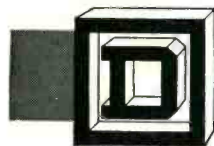

SQUARE D COMPANY

ELMHURST, NEW YORK

GLENDALE, CALIFORNIA

These little D-C Relays SOLVE SHOCK AND VIBRATION PROBLEMS!

EXTRA STURDY CUBICAL FRAME
BALANCED ARMATURE SUSPENSION
55% GREATER COIL VOLUME
TROUBLE-FREE WIRE SIZES
(up to 7,000 ohms resistance using 42-gauge wire and larger)

To Withstand
15 G's VIBRATION while operating
25 G's OPERATIONAL SHOCK
75 G's SURVIVAL SHOCK

Designed throughout for maximum resistance to mechanical stress, Struthers-Dunn 181 low-voltage d-c relays are practically immune to false contact operation under extreme shock or vibration. Ideal for the toughest mobile, portable, aircraft or shipboard applications. Write for Data Bulletin 2610.

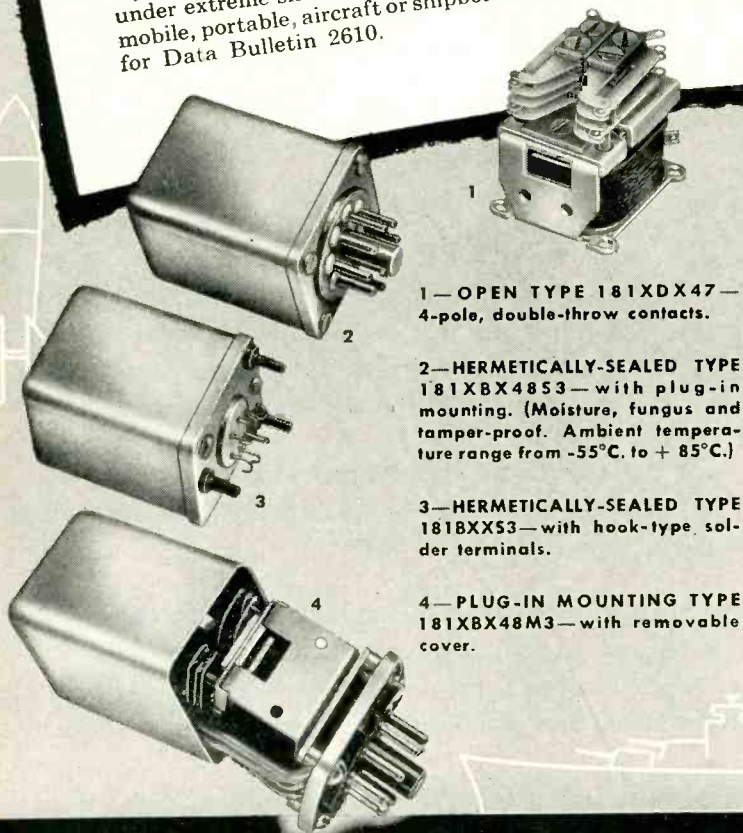

1—OPEN TYPE 181XD47—
4-pole, double-throw contacts.

2—HERMETICALLY-SEALED TYPE
181XB4853—with plug-in
mounting. (Moisture, fungus and
tamper-proof. Ambient tempera-
ture range from -55°C. to + 85°C.)

3—HERMETICALLY-SEALED TYPE
181BX53—with hook-type solder
terminals.

4—PLUG-IN MOUNTING TYPE
181XB48M3—with removable
cover.

STRUTHERS-DUNN

STRUTHERS-DUNN, INC., 150 N. 13th Street, Philadelphia 7, Pa.

BALTIMORE • BOSTON • BUFFALO • CHARLOTTE • CHICAGO • CINCINNATI
CLEVELAND • DALLAS • DETROIT • KANSAS CITY • LOS ANGELES
MINNEAPOLIS • MONTREAL • NEW ORLEANS • NEW YORK • PITTS-
BURGH • ST. LOUIS • SAN FRANCISCO • SEATTLE • SYRACUSE • TORONTO

TUBES AT WORK

(continued)

Electric Co., Ltd. of England.

The size of the room is about 18 × 13 × 13 feet, before lining, and the walls, floor and ceiling are covered with nearly 3,000 Fibreglass wedges, each 3 feet long. These wedges are not supported by the usual eggbox construction but are in a welded wire frame arranged so as to produce the minimum sound reflection.

The door, which is also covered with wedges, presented an unusual engineering problem. Although the door opening is only 2½ feet wide the attached wedges are 3½ deep overall and so the tips would become damaged if the door were to open and shut in the usual way. To remove this difficulty the hinges of the door are designed so that it moves at right angles to the wall of the room during the final stage of closing. This is done by guiding it in tracks at right angles to the wall.

Inside the room, two overhead tracks have been fitted at right angles to each other. Their purpose is to enable the microphone carriages to be moved. An important feature of these carriages is that they have automatic brakes which ensure that a microphone cannot move during tests.

Across the floor of the room is a trolley track ending in a turntable. This enables heavy objects to be wheeled into the room on the track through the door, revolved on the turntable and suitably positioned in the room. Although the turntable is very useful for positioning equipment, it was included mainly for measuring the sound distribution round an object, for example, determining the polar response curve of a microphone. Means are provided for rotating the turntable from outside the room.

The floor of the room is lined with wedges and immediately above their tips is a wire mesh false floor which is virtually "transparent" to sound. When the greatest accuracy is required this mesh can be removed, together with most of the track and supporting posts.

Photoelectric Gages

Many branches of engineering have needs for the measurement of rapidly varying displacements

Specify **GLENCO** MINIATURE CERAMIC PLATE CAPACITORS

... for minimum size
... maximum dependability
... convenient rectangular shape

GLENCO SUBMINIATURE CAPACITORS FOR COUPLING AND BYPASS APPLICATIONS								
CBM MINIATURE 500 V. D.C. SINGLE PLATE		SMCB SUB-MINIATURE 250 V. D.C. SINGLE PLATE		CAPACITY MFD.	SMCB SUB-MINIATURE 250 V. D.C. DOUBLE LAYER		SMCB SUB-MINIATURE 250 V. D.C. MULTILAYER	
SIZES IN INCHES					SIZES IN INCHES			
L	W	L	W		L	W	L	W
.19	.14	.12	.12	.0005				
.25	.19	.18	.15	.001				
.50	.40	.28	.25	.005				
.70	.52	.50	.40	.01	.30	.19		
		.80	.60	.05	.61	.43	.48	.33
				.10	.88	.62	.65	.45
				.50			.70	.55
				1.0			1.0	.80
D=.120		D=.080			D=.120		D=.150-.800	

SPECIFICATIONS FOR CBM AND SMCB* COUPLING AND BYPASS CAPACITORS

- FLASH TESTED AT 3 TIMES RATED D.C. VOLTAGE
- POWER FACTOR LESS THAN 1%
- INSULATION RESISTANCE EXCEEDS 10,000 MEGOHMS
- MEET ALL RMA SPECIFICATIONS

*Types CBM and SMCB are shown as typical examples of the space saving possible with GLENCO capacitors. Many more standard types, including a great variety of temperature compensating ceramic capacitors, are available. Quotations on these or types to customers' specification will be supplied promptly on request.

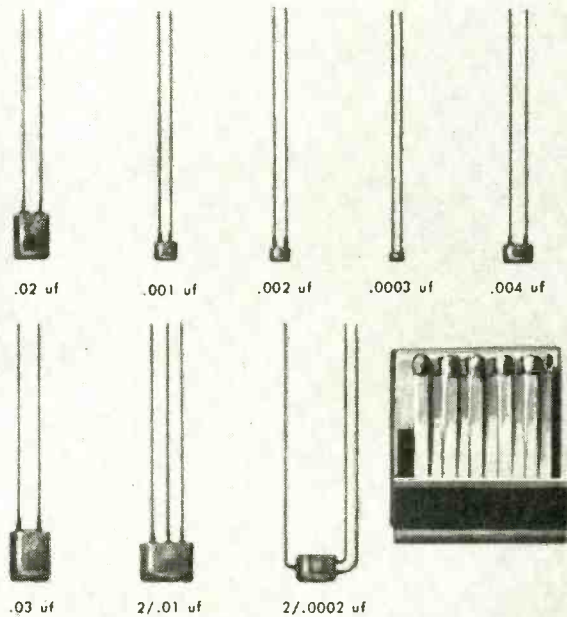
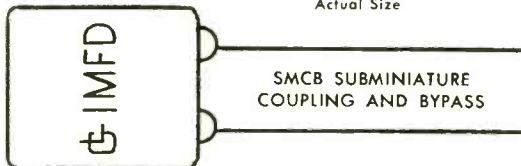
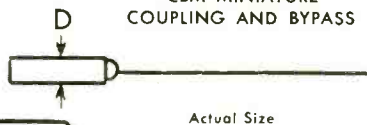
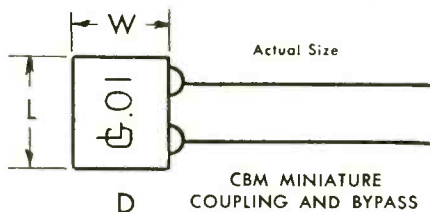

TYPE TC — TEMPERATURE COMPENSATING CERAMIC PLATE CAPACITORS

TYPE CBM — MINIATURE COUPLING AND BYPASS CAPACITORS

TYPE SMCB — SUB-MINIATURE COUPLING AND BYPASS CAPACITORS

GLENCO ceramic capacitors combine extreme compact size with convenient rectangular shape for simplified mounting in limited space. Their smaller size, lighter weight are the result of a unique, continuous micro-sheet ceramic process developed by GLENCO for miniaturizing ceramic capacitors. Step-by-step control from raw material to finished ceramic dielectric insures uniform high quality, high density and high dielectric strength. Silver, fused at high temperature to the ceramic dielectric, provides a stable, intimately bonded electrode.

GLENCO capacitors are hermetically sealed against moisture and protected against contact with adjacent components by a special dipped phenolic resin and a high flow-point wax impregnant. Simple one-piece construction results in a high self-resonant frequency, making them ideal for high frequency by-pass applications.

PIEZO ELECTRIC ELEMENTS FOR PICKUPS AND MICROPHONES
ULTRASONIC EQUIPMENT BUILT TO SPECIFICATIONS
HYDROPHONES, PRESSURE GAUGES, ACCELEROMETERS, SEISMOMETERS, VIBROMETERS
Write for Complete Information Today
GULTON MFG. CORP. • METUCHEN, NEW JERSEY

GLENCO CORPORATION
DURHAM AVENUE, METUCHEN, NEW JERSEY

NOTE! A FEW TERRITORIES ARE STILL OPEN FOR WIDE AWAKE REPRESENTATIVES IN SELECTED AREAS—INQUIRIES INVITED.



SPLENDID ISOLATION

Because its superiority is unchallenged, Signal Generator type TF 867 stands alone, in splendid isolation. Especially noteworthy are an expanded wide-view scale covering 15 kc/s to 30 Mc/s and a concentric terminating unit which, while showing exact circuit conditions on an animated diagram, is also a dummy aerial and impedance source of 75Ω or 13Ω. Other facilities include crystal standardisation, freedom from unwanted frequency modulation, deep amplitude or carrier shift modulation and



SIGNAL GENERATOR TF 867

stabilised output control. Output is variable from 4V to 0.4μV and calibration indicates the true artificial signal e.m.f. irrespective of load.

Further information from any of the following addresses:

MARCONI INSTRUMENTS LIMITED

U.S.A. Sales and Service: 23-25 Beaver Street, NEW YORK, 4

CANADA: CANADIAN MARCONI LTD., Marconi Building, St. Sacrament Street, MONTREAL
ENGLAND: (Head Office and Works) ST. ALBANS, HERTFORDSHIRE

CABINETS • CHASSIS • PANELS • RACKS

Planning **ELECTRONIC EQUIPMENT?**
Investigate the **ECONOMIES**
of **PAR-METAL HOUSINGS!**

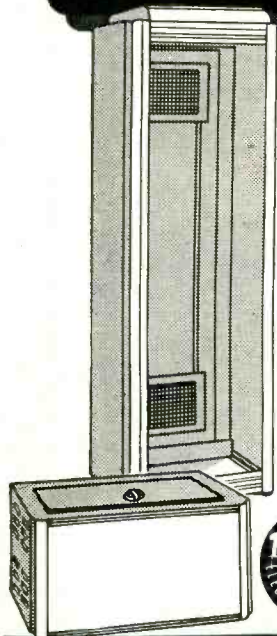

We manufacture Metal Housings for every purpose — from a small receiver to a deluxe broadcast transmitter. And the cost is low!

Because we specialize in the Electronics field, Par-Metal Products excel in functional streamlined design, rugged construction, beautiful finish, and economy.

Remember, Par-Metal equipment is made by electronic specialists, not just a sheet metal shop.

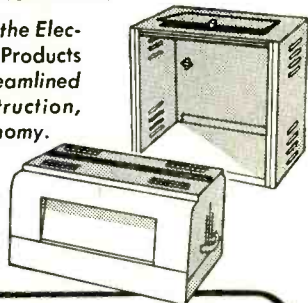

PAR-METAL

PRODUCTS CORPORATION
32-62 — 49th ST., LONG ISLAND CITY 3, N. Y.
Export Dept.: Rocke International Corp.
13 East 40 Street, New York 16, N. Y.



WRITE FOR CATALOG!

perfect
for 3 speed playing

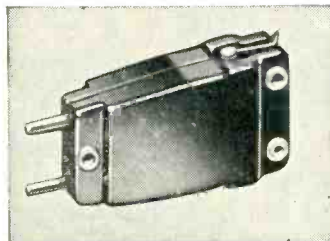

WEBSTER ELECTRIC
MODEL "A" CARTRIDGE
with TWIST
MECHANISM

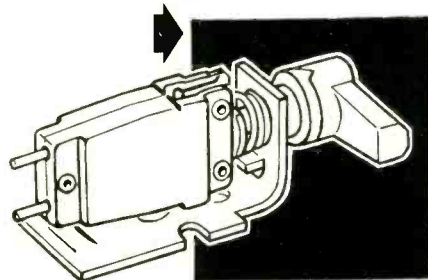

- ✓ Outstanding performance... small streamline design that fits modern tone arms.
- ✓ No chance to damage leads or play in incorrect position.
- ✓ Easy installation.

The Model "A" cartridge and twist mechanism are assembled at factory ready for installation in tone arm... no adjustment or modification necessary. Completely assembled it gives positive tracking at all playing speeds. High vertical and lateral compliance eliminates "skating." Positive indexing eliminates the possibility of twisting and damaging leads. The cartridge rotates through a 180 degree arc for playing either 33 $\frac{1}{3}$, 45 or 78 R.P.M. records. There are no parts to get out of order. Write for data sheet and prices. Webster Electric Co., Racine, Wisconsin. Established 1909.

WEBSTER ELECTRIC

RACINE • WISCONSIN
"Where Quality is a Responsibility and Fair Dealing an Obligation"



GLOBAR

CERAMIC RESISTORS

... for best results in standard or special purpose applications

GLOBAR brand ceramic resistors offer unusual and valuable characteristics for bettering circuit performance in radio, television and industrial applications. Manufactured to meet your exact specifications, these resistors assure extreme accuracy of operation. Precision methods of control and inspection in their manufacture provide maximum uniformity and dependability.

The accompanying table lists a few different types of resistors available. GLOBAR engineers will be glad to work with you in applying any of these or other types to your designs. In the meantime, obtain more complete information by writing for Bulletins R, GR-2 and GR-3. Address Dept. V-100, The Carborundum Company, GLOBAR Division, Niagara Falls, New York.

TYPE	CHARACTERISTICS	TYPICAL APPLICATIONS
A	Low negative voltage and temperature sensitivity.	General purpose resistor for radio receivers and transmitters.
B	Medium negative voltage and temperature sensitivity.	Instrument compensation. X-Ray equipment.
BNR	High negative voltage sensitivity.	Magnetic valves. Motor governors.
CX	Low negative voltage and low positive temperature sensitivity.	Radio transmitters for dummy antenna and parasitic suppressors.
F	High negative temperature sensitivity.	AC-DC radio receivers to prevent surge currents in tube and pilot light filaments.

GLOBAR Ceramic Resistors

BY CARBORUNDUM

TRADE MARK



"Carborundum" and "Globar" are registered trademarks which indicate manufacture by The Carborundum Company

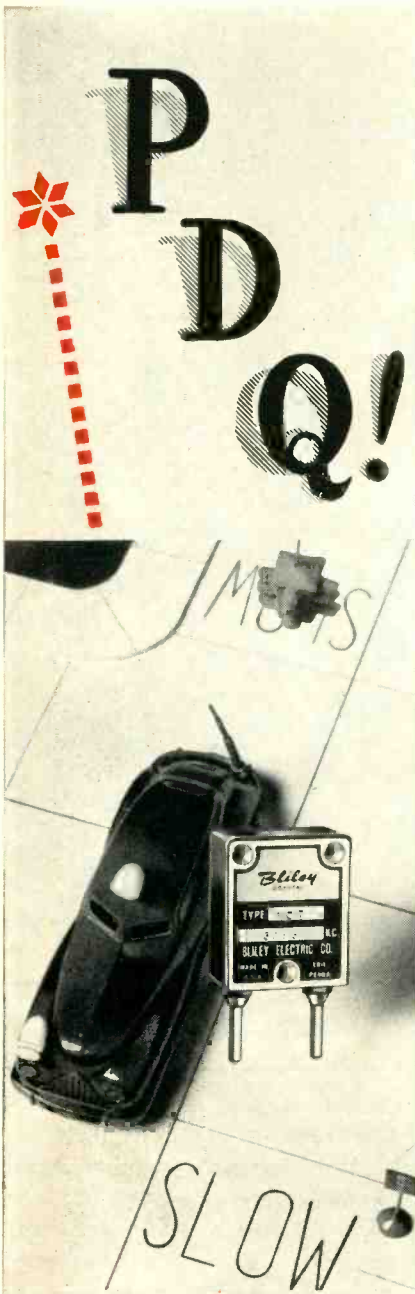

Shown:
Bliley type MC-7

POLICE SERVICES DEMAND QUALITY!

Yes, all mobile services demand dependable crystal performance. Bliley engineering skill plus craftsmanship throughout production is quality. Your frequency control will be better with Bliley, the top choice for 20 years.

Bliley
CRYSTALS

BLILEY ELECTRIC COMPANY
UNION STATION BUILDING
ERIE, PENNSYLVANIA

TUBES AT WORK

(continued)

or pressures and a new and interesting development in this field is a photoelectric pressure gage by C.A.V. Ltd and Ricardo and Co. Ltd.

The principle of the device is that displacements or pressure differences are utilized to modulate a beam of light falling on to a photocell and the resulting electrical changes are ultimately applied to an oscilloscope where they are translated into direct indications of the quantities concerned.

The gaging mechanism is housed in a hollow metal cylinder and is composed of a light source, a slit of variable width and a photocell. The light beam is arranged to be parallel to the axis of the cylinder, which has the lamp and cell on either side of it. The slit, which is horizontal, is interposed in the beam.

For pressure measurements the edge of the slit shutter is linked to a horizontal circular diaphragm fixed to the base of the gage and moving with it. Pressures to be measured are applied to the diaphragm from a pipe.

For displacement measurements a different operating mechanism is used. It consists of an adaptor unit carrying a push rod which moves the slit shutter. The slit is decreased by upward displacement of the rod, which is restored to its normal position by a spring.

When the equipment is in use the current through the photocell varies directly with the width of the slit, providing that this is over 4 mils. The current change never exceeds approximately 1.9μ amp and a change of this order corresponds to variation of the slit by about 5 mils.

Generally speaking, the gage is connected to a voltage amplifier which feeds the oscilloscope, the cell output being taken from a 100,000-ohm resistor. For applications involving vibration or other rapidly-varying effects, the frequency response of the gage is important and is limited by the photocell circuit, either the cell itself or the time constant of the output circuit, which is determined by the output resistance and any stray capacitance which is effectively connected in parallel with it.

Calibration of both the pressure

SUPERIOR ELECTRONIC PRODUCTS

used in the
GUN STRUCTURE OF TELEVISION TUBES



ANODE AND GRID CYLINDERS—

Straight cut, angle cut or rolled edge
Tubing produced to very close tolerances.

DISC CATHODE ASSEMBLY—

Precision made and laboratory controlled to assure correct emission and cut-off characteristics.

Write for Print ED1-1.

The expanding television industry has turned to Superior's Electronic Division for the conception and production of these vital parts within the television tube.

THE BIGGER NAME IN SMALL TUBING
Superior

TUBE COMPANY

ELECTRONIC DIVISION
2500 GERMANTOWN AVENUE
NORRISTOWN, PENNA.

FREED

TRANSFORMERS & INSTRUMENTS

"PRODUCTS OF EXTENSIVE RESEARCH"



NO. 1060 VACUUM TUBE VOLTMETER
INPUT IMPEDANCE
50 MEGOHMS



NO. 1030 LOW FREQUENCY "O" INDICATOR

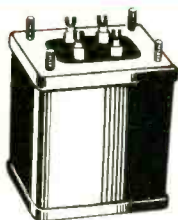

HIGH FIDELITY TRANSFORMERS
1/2 DB 20 CPS TO 30 KC

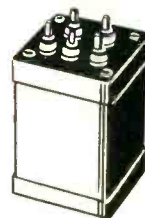

DISCRIMINATORS
10 CPS TO 1 MC

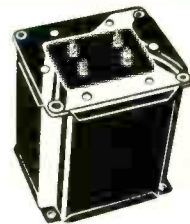

COMMERCIAL COMPONENTS
QUALITY —
DEPENDABILITY — PRICE

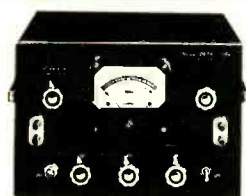

NO. 1140 NULL DETECTOR
COMPLETE WITH
SELECTIVE CIRCUITS



NO. 1020 MEGOHMMETER
2,000,000 MEGOHMS
DIRECT READING



HERMETICALLY SEALED COMPONENTS
TO MEET MIL-T-27 SPECS.

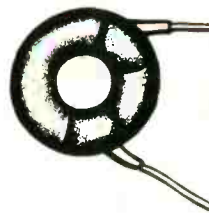

TOROIDAL INDUCTORS
60 CPS TO 1 MC



MINIATURE INDUCTORS
1000 CPS TO 100 KC



NO. 1210 NULL DETECTOR & VACUUM TUBE VOLTMETER

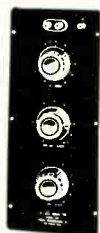

DECADE INDUCTORS
30 CPS TO 300 KC



SUB MINIATURE HERMETICALLY SEALED TOROIDAL INDUCTORS



SUB MINIATURE HERMETICALLY SEALED COMMUNICATION COMPONENTS



SLUG TUNED COMPONENTS
1000 CPS TO 1 MC

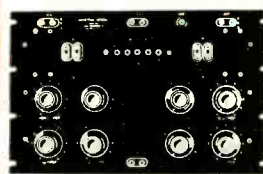

NO. 1150 UNIVERSAL BRIDGE
5 A.C. BRIDGES IN ONE UNIT



NO. 1010 COMPARISON BRIDGE
FAST, ACCURATE, RELIABLE

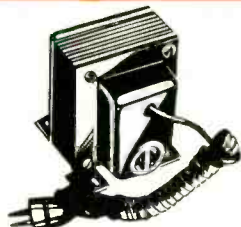

STEPDOWN TRANSFORMERS
50 WATTS TO 3 KW



PULSE TRANSFORMERS
FROM WATTS TO MEGAWATTS



POWER TRANSFORMERS
RUGGED, DEPENDABLE,
INEXPENSIVE.



1170 D.C. SUPPLY
DIRECT CURRENT UP TO
500 MA.



NO. 1110 INCREMENTAL INDUCTANCE BRIDGE
A NECESSITY FOR EVERY LAB.



PRECISION FILTERS
10 CPS. TO 1 MC.



CHANNEL MOUNTING
INEXPENSIVE—RELIABLE



FOSTERITE TREATMENT
ANE-19 SPECS.

SEND FOR LATEST CATALOG!

FREED TRANSFORMER CO., INC.

DEPT. OE 1718-36 WEIRFIELD ST., (RIDGEWOOD) BROOKLYN 27, NEW YORK



Patents Regd Trade Mark.

THE LOWEST EVER CAPACITANCE OR ATTENUATION

We are specially organized to handle direct enquiries from overseas and can give

IMMEDIATE DELIVERIES FOR U.S.A.

Billed in Dollars Settlement by your check. Transaction as simple as any local buy.

TRANSRADIO LTD
CONTRACTORS TO H.M. GOVERNMENT
138A CROMWELL ROAD-LONDON SW7, ENGLAND
CABLES: TRANSRAD. LONDON.

LOW ATTEN TYPES	IMPED OHMS	ATTEN db/100ft at 100 Mcs.	LOADING Kw	O.D."
A 1	74	1.7	0.11	0.36
A 2	74	1.3	0.24	0.44
A 34	73	0.6	1.5	0.88
LOW CAPAC TYPES	CAPAC mmf/ft	IMPED OHMS	ATTEN db/100ft 100 Mcs.	O.D."
C 1	7.3	150	2.5	0.36
PC 1	10.2	132	3.1	0.36
C 11	6.3	173	3.2	0.36
C 2	6.3	171	2.15	0.44
C 22	5.5	184	2.8	0.44
C 3	5.4	197	1.9	0.64
C 33	4.8	220	2.4	0.64
C 44	4.1	252	2.1	1.03

HIGH POWER FLEXIBLE

PHOTOCELL CABLE

V. L. C. ★

★ Very Low Capacitance cable.



DO YOU HAVE AN INSTRUMENTATION PROBLEM?

Bendix-Pacific telemetering facilities can provide you with any phase of a complete instrumentation service. These include:

- ★ The standard AN/DKT-3 sub-miniature telemetering components which remotely measure and indicate acceleration, motion and position, pressure, strain, temperature, vibration, velocity, voltage and current. Transmitters up to 15 watts of power are available.
- ★ Application engineering to adapt the Bendix-Pacific System to each specific problem.
- ★ Installation and calibration services.
- ★ Aircraft and missile antenna design and radiation analysis.
- ★ Flight testing, providing all ground station facilities and reduction and analysis of data.

RADAR BEACON

Bendix-Pacific has developed for restricted use an exceptionally small, compact radar beacon for use in the common radar bands to facilitate vehicle tracking.

Inquiries from qualified companies and agencies for complete engineering data are invited.



Eastern Engineering Office: 475 Fifth Ave., N. Y.
TO MEASURE—TO INDICATE—TO WARN AT A DISTANCE

FREE Send for **ALLIED'S NEW 1951 CATALOG!**

- **ELECTRONIC SUPPLIES for INDUSTRY**
- **BROADCAST STATION SUPPLIES**

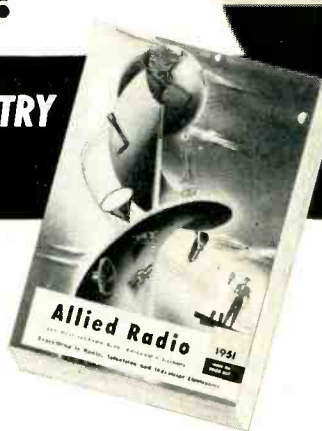

World's Largest Stocks • Complete Expert Service from One Central Supply House

Simplify your purchasing problems—send your consolidated orders to ALLIED—the single, complete source for all electronic supplies. Rely on ALLIED for the world's largest stocks of parts, tubes, test instruments, audio equipment, accessories—complete quality lines of electronic supplies ready for immediate shipment from stock. ALLIED'S expert Industrial and Broadcast Station supply service saves you time, effort and money. Send today for your FREE copy of the 1951 ALLIED Catalog—the only complete guide to electronic supplies for industrial and broadcast station applications.

ALLIED RADIO CORP.

833 W. Jackson Blvd., Dept. 11-K-O • Chicago 7, Illinois

Everything in Electronics from ONE Source

212 PAGES: Equipment for Research, Development, Maintenance and Production Operations

Send for **1951 ALLIED CATALOG**

Terminal Shaft Assembly Makes Bearings, Oil Supply Last Longer

By using two baffles . . . one a brass baffle that is an integral part of the terminal gear plus a second baffle that surrounds the first . . . Telechron engineers have constructed a terminal shaft assembly that assures controlled lubrication in Telechron timing motors. This results in cutting down bearing wear and making the sealed-in oil supply last for years.

Controlled lubrication is but one of many reasons why *all Telechron timing motors are instantly, constantly synchronous.*

Wherever split-second timing or

precise control of lightweight moving parts is required, designers invariably specify Telechron motors. If either of these factors enters into your product design, get in touch with a Telechron application engineer. Backed by the experience that makes all electric timing possible (virtually all frequency-controlling master clocks in power stations are made by Telechron), he can show you how a Telechron timing motor can help you. Send coupon below for complete data. TELECHRON INC. A General Electric Affiliate.

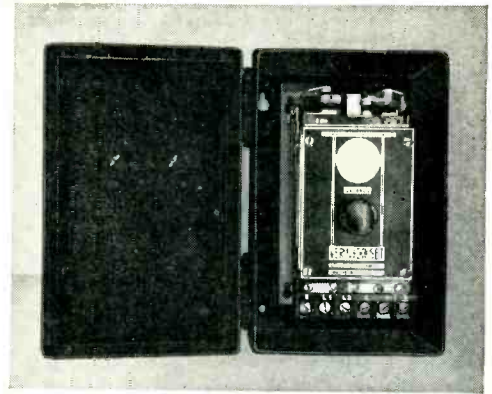
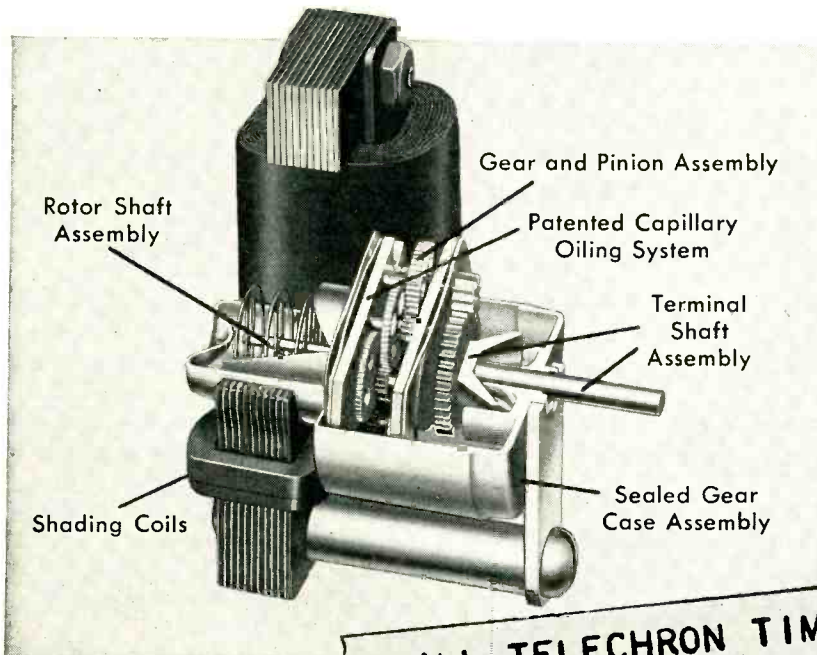

THIS PROCESS TIMER uses the Telechron Type B motor. Accuracy is assured because the Type B . . . like all Telechron Timing Motors . . . is instantly, constantly synchronous.

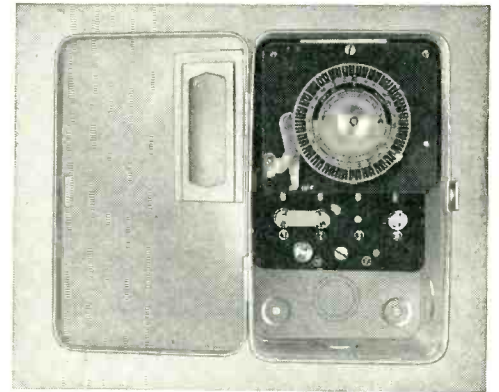

THIS TIME SWITCH uses a Telechron H3 Motor recommended for slow-speed, light-duty purposes such as timing as well as switching and controlling devices.

◀ **TELECHRON TYPE B SYNCHRONOUS MOTOR.** For medium duty application such as switches, combination recording and controlling mechanisms, and various types of control equipment.

Telechron[®]

ALL TELECHRON TIMING MOTORS ARE

INSTANTLY . . . CONSTANTLY SYNCHRONOUS

TELECHRON INC.
40 Union Street
Ashland, Massachusetts

Please send me information on sizes and types of Telechron Synchronous Motors. My possible application is:

- | | | | |
|-------------------------------------|--------------------------|--|--------------------------|
| Instruments | <input type="checkbox"/> | Communications Equipment | <input type="checkbox"/> |
| Timers | <input type="checkbox"/> | Other (please fill in) | <input type="checkbox"/> |
| Electric Appliances | <input type="checkbox"/> | | |
| Cost Recorders | <input type="checkbox"/> | | |
| Advertising, Display Items | <input type="checkbox"/> | | |
| Juke Boxes | <input type="checkbox"/> | | |
| Air Conditioning & Heating Controls | <input type="checkbox"/> | <input type="checkbox"/> Please send new Catalog | |

NAME.....
COMPANY.....
ADDRESS.....
CITY..... ZONE.....
STATE.....



WHEN YOU NEED A MINIATURE TRANSFORMER

TUBES AT WORK

(continued)

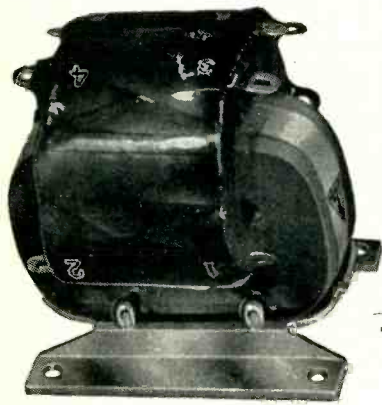

CHECK THESE FEATURES OF THE HORNET

- ✓ **SIZE AND WEIGHT** Because they are designed for high operating temperatures, Hornet Transformers and Reactors have only about one-fourth the size and weight of Class A units of comparable rating.
- ✓ **VOLTAGE RATINGS** Designs are available for RMS test voltages up to 10,000 volts at sea level, and up to 5,000 volts at 50,000 feet altitude. Power ratings from 2VA to 5KVA.
- ✓ **POWER FREQUENCIES** These units are designed to operate on 380/1600 cps aircraft power supplies, 60 cps power supplies, and any other required power frequency.
- ✓ **AMBIENT TEMPERATURES** Hornet Units can be designed for ambient temperatures up to 200 deg. C. Size for any given rating depends upon ambient temperature and required life.
- ✓ **LIFE EXPECTANCY** Extensive tests indicate that the life expectancy of Hornet units at continuous winding temperatures of 200 deg. C. is over 50,000 hours.
- ✓ **MOISTURE RESISTANCE** Since Hornet Transformers and Reactors contain only inorganic insulation, they are far more moisture resistant than conventional Class A insulated units.
- ✓ **EFFICIENCY** Regulation and efficiency of Hornet Transformers compare favorably with Class A units.
- ✓ **SPECIFICATIONS** Hornet Transformers meet the requirements of Government specifications covering this type of equipment.



Bulletin B300, containing full electrical and dimensional data on Hornet units, is now available. Write for it, or tell us your specifications for special units.



**NEW YORK
TRANSFORMER CO., INC.**
ALPHA NEW JERSEY

and displacement types is done by applying known quantities and then noting the corresponding indications on the c-r tube. This method has the advantage that it can be applied quickly and it reduces to a minimum the errors which could arise owing to changes in the gage during the interval between calibrating instrument and using it.

Believed to be the first practical instrument of its kind for general use, an ionization voltage tester has been designed as a simple means of determining the threshold voltage at which ionization occurs in a dielectric. It should prove of considerable value in researches into insulating materials.

The instrument consists of two main circuits, the first containing a generator of direct voltage, continuously adjustable up to a maximum of 5 kv by means of a single control. The positive pole of the generator is taken, via an output terminal, to the material under test, which is series-connected to the second circuit, which forms the input of a detector-amplifier. Output from the amplifier is fed into a small loudspeaker and a cathode-ray indicator is included to denote the passage of current.

As the voltage across the sample is increased, a point is reached when ionization commences and is denoted by a popping sound in the loudspeaker. A volume control is provided to enable the sound to be adjusted to a convenient level, because the intensity and frequency of the sound increases as ionization progresses. Simultaneously the miniature c-r tube indicates direct-current flow.

The instrument has a wide range of uses, testing of cables, motors, insulation on wires, high-value resistors; also the detection of ionization in gas pockets in insulation or dielectrics.

New Photocells

Developments in the field of photo-conductive cells include a miniature lead-sulphide cell of small size and simple construction for use in applications where the cell will not be cooler; a new pattern coolable lead-sulphide cell incorporating numerous improvements including interchangeable de-

Once
Again

MITCHELL-RAND Demonstrates Leadership!

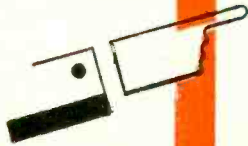

Produces **2** new Wax Compounds
for greater protection
against extreme high heat and
extreme low temperatures!

3760 HIGH MELTING POINT WAX for Impregnating and Dip Coating

won't flow under extreme high heat
won't crack under extreme cold!

3767-A CORONA SUPPRESSING PLASTIC for Dip Coating

won't sag or sweat under extreme heat
won't crack under extreme cold!

SPECIFICATIONS

MELTING POINT (DRIP)	260/265 F
COLD FLOW (M-R)	250/255 F
PENETRATIONS	
32/200/60	15-16
77/100/5	17-19
115/50/5	20-22
COLOR	Tan
APPLICATION TEMPERATURE	300/350 F
SPECIFIC GRAVITY	0.90
VISCOSITY (SAYBLT. UNIV.) @ 325 F	40-42 seconds
FLASH POINT	500 F
ELECTRICAL PROPERTIES	
POWER FACTOR	0.023 (10 ⁶ cycles; 77 F)
DIELECTRIC CONSTANT	2.19 (10 ⁶ cycles; 77 F)

COLD FLOW (M-R)	272/277 F
SOFTENING POINT (B&R)	190/195 F
DIPPING TEMPERATURE	325/375 F
MELTING POINT (DRIP)	275/285 F
COLOR	Tan
ADHESION	Good
PENETRATION 77/100/5	8-10
SPECIFIC GRAVITY	1.01
FLASH POINT	480 F
ELECTRICAL PROPERTIES (Representative Sample)	
Dielectric Strength	368 V/mil (77 F; 60 Cycles)
Dielectric Constant	2.51 (77 F; 10 ⁶ Cycles)
Power Factor	0.0069 (77 F; 10 ⁶ Cycles)

3760, Impregnating and Dip Coating WAX COMPOUND, was developed to meet the needs of applications which must resist flow at temperatures above the boiling point of water, and also which must resist cracking at temperatures below zero degrees F.

3760, with good electrical properties, resistance to bleeding at high temperatures, low application viscosity and high drip melting point, is recommended for moisture proofing coils, transformers, capacitors, etc.

TESTS—HIGH TEMPERATURE

Using paper tubular capacitor samples, the tubes were impregnated with, and the assembled units were flash dipped in 3760 (coating approximately 15 mils thick), the units were then subjected to oven tests at 220 F for 24 hours. **NO SAGGING OR BLEEDING OF THE COATING WAS EVIDENT.**

TESTS—LOW TEMPERATURE

The same units were cold tested by being placed in a cold chamber at -40 F for a period of one hour. The units were then removed and permitted to return to room temperature. **INSPECTION SHOWED THAT THIS LOW TEMPERATURE TREATMENT CAUSED NO CRACKS IN THE COATING OF 3760 . . .** and the surface obtained by dip coating with 3760 showed good resistance to blocking at temperatures normally encountered in shipping.

3767-A, CORONA SUPPRESSING PLASTIC, was developed to reduce or eliminate corona around certain points on television components, and similar electrical parts, which operate at high potentials. Application in the form of a corona suppressing "tire" on the periphery of "flyback" transformer coils and similar units is the primary function of 3767-A. The customary method for applying 3767-A is to dip or roll the units to be coated in a molten bath of the insulation.

Since low power factor and high dielectric strength are particularly desirable in this type of insulation, this material combines the best possible electrical properties consistent with the necessary physical properties. The surface obtained with this corona suppressing plastic is particularly smooth and free from ridges and bumps. This feature of itself reduces the evolution of corona. During the development of 3767-A particular attention was given to the physical stability of applied coatings at extremes of high and low temperatures.

FUNCTIONAL TESTS of this material applied in moderately heavy coatings on flyback transformer coils **SHOWED THAT 3767-A WILL WITHSTAND A CYCLE OF 24 HOURS AT -40 C FOLLOWED BY 24 HOURS AT 125 C WITHOUT THE APPEARANCE OF CRACKS AT THE LOW TEMPERATURE OR SAGGING AND SWEATING AT THE HIGH TEMPERATURE.**

M-R THE
ELECTRICAL
INSULATION
HEADQUARTERS
FOR 61 YEARS.



Write for your laboratory test samples . . . free upon request.

MITCHELL-RAND INSULATION CO. Inc.

51 MURRAY STREET • Cortlandt 7-9264 • NEW YORK 7, N. Y.

A PARTIAL LIST OF M-R PRODUCTS: FIBERGLAS VARNISHED TUBING, TAPE AND CLOTH • INSULATING PAPERS AND TWINES • CABLE FILLING AND POTHEAD COMPOUNDS • FRICTION TAPE AND SPLICE • TRANSFORMER COMPOUNDS • FIBERGLAS SATURATED SLEEVING • ASBESTOS SLEEVING AND TAPE • VARNISHED CAMBRIC CLOTH AND TAPE • MICA PLATE, TAPE, PAPER, CLOTH, TUBING • FIBERGLAS BRAIDED SLEEVING • COTTON TAPES, WEBBINGS AND SLEEVINGS • IMPREGNATED VARNISH TUBING • INSULATED VARNISHES OF ALL TYPES • EXTRUDED PLASTIC TUBING

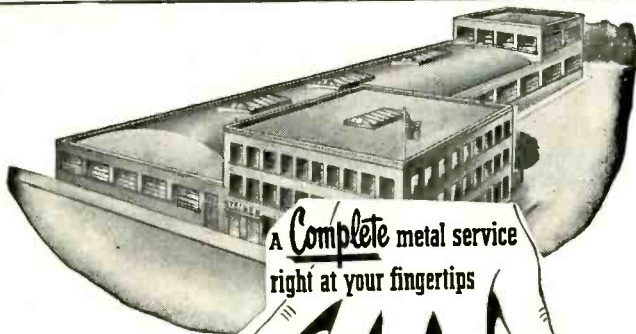

A Complete metal service
right at your fingertips

**SCREW
MACHINE
PRODUCTS**

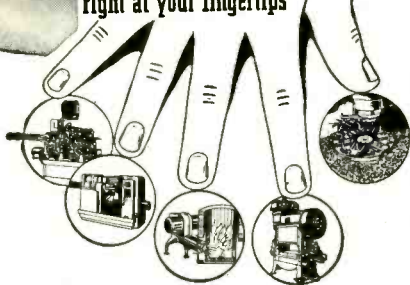

Housings
Assemblies
Metal Trimmings
Electronic Tube
Parts

Metal • Fibre **STAMPINGS** Phenolite • Plastic

Complete Fabrication Facilities Under One Roof
Exactng Specifications Met—Rigid Inspection System

WM. STEINEN MFG. CO.

Bruen Cor. Hamilton St.



Newark 5, New Jersey

WE INVITE

YOUR INQUIRY



*You Can See
Right Through Me*

"There's nothing dense about me — everyone sees through me! But I'm MICRO-WEAVE Tracing Cloth and in my business transparency counts a lot. That's one reason I'm so popular with draftsmen — they can see the finest, lightest lines with crystal clearness *without* eye strain. People say that I'm the nearest thing to clear glass in tracing cloth."

MICRO-WEAVE exceeds all specifications in minute perfection of weave-in durability under repeated erasures — in minimum feathering — in better blueprints — in longer life. Test MICRO-WEAVE on your drawing board. Send for generous sample.



A HOLLISTON MILLS PRODUCT
Micro-Weave
All American
TRACING CLOTH
White or Blue for Ink or Pencil

THE HOLLISTON MILLS, INC.

NORWOOD, MASS.

NEW YORK

PHILADELPHIA

CHICAGO

★ MICRO-WEAVE is backed by Holliston's 50 years of leadership and experience in developing special cloths for industry.

American Beauty

ELECTRIC SOLDERING IRONS

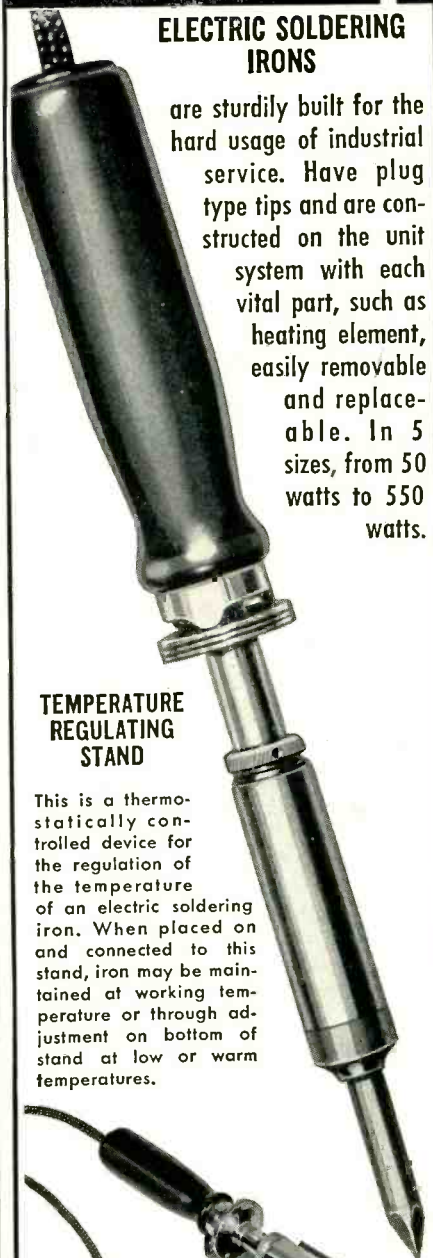

are sturdily built for the hard usage of industrial service. Have plug type tips and are constructed on the unit system with each vital part, such as heating element, easily removable and replaceable. In 5 sizes, from 50 watts to 550 watts.

TEMPERATURE REGULATING STAND

This is a thermostatically controlled device for the regulation of the temperature of an electric soldering iron. When placed on and connected to this stand, iron may be maintained at working temperature or through adjustment on bottom of stand at low or warm temperatures.



For descriptive literature write

110-1

**AMERICAN ELECTRICAL
HEATER COMPANY**
DETROIT 2, MICH., U. S. A.

YOUR QUESTIONS...OUR ANSWERS*

May bring a solution to your

D. C. AMPLIFICATION PROBLEMS!

The Microsen D. C. Amplifier is designed for stable, accurate, and economical amplification covering an exceptionally wide range of applications. These fields of application may suggest, duplicate, or offer a solution to your particular D. C. Amplification problem.

Simple, compact and portable, the Microsen D. C. Amplifier has three different ranges in a single model. The Microsen Balance, an electro mechanical feedback amplifier, combines the advantages of high torque to current input ratio with rugged, shock-resistant construction.

Available models include Voltage, Current and Potentiometer Type Amplifiers, Direct Current Converters, Direct Current Transformers, and engineered designs to meet special requirements.

Typical applications in the field of measurement include:

THERMOMETRY in combustion research, gas turbine development, thermocouple inspection, meteorology, distillation processes.

PHOTOMETRY in fluid flow and turbulence, polar-

imetry, physiology of blood and density.

GAS ANALYSIS in mixture control, efficiency of filters and detection of explosive mixtures.

ELECTRICAL BRIDGES in resistor inspection, moisture detection, conductivity measurements, vacuum gauging, transient stresses.

ELECTRONICS in tube development, vacuum gauging and wave guide studies.

ELECTROLYSIS in electrolytic plating, electrolytic process and production control.

Input elements include thermocouples, photo cells, pirani gauges, strain gauges and others. The instrument is used generally with a recorder. The output can also be applied to a suitable milliammeter indicator or to actuate automatic control relays or signal devices. Design advantages include accuracy, sensitivity, stability and high speed response.

Inquiries for modification within the useful scope of the Microsen D. C. Amplifier are invited. If possible, such inquiries should contain complete application specifications.

MICROSEN D. C. AMPLIFIER



MICROSEN

ELECTRICAL INSTRUMENTS

A Product of
MANNING, MAXWELL & MOORE, INC.
STRATFORD • CONNECTICUT

Makers of 'Microsen' Electrical and 'American' Industrial Instruments, 'Hancock' Valves, 'Ashcroft' Gauges, 'Consolidated' Safety and Relief Valves. Builders of 'Shaw-Box' Cranes, 'Budgit' and 'Load Lifter' Hoists and other lifting specialties.



Manning, Maxwell & Moore, Inc.
250 East Main Street
Stratford, Conn.

We are interested in the Microsen D. C. Amplifier.
Application specifications and/or specific queries attached
Please send bulletin describing the instrument

Name _____
Position _____
Company _____
Street Address _____
City and State _____

BROADCAST ENGINEERS

OK



Model 650

Ultra-Wide-Range
High Fidelity
Laboratory Calibrated



BROADCAST DYNAMICS

The rapidly growing preference for E-V Broadcast Microphones in more and more TV, FM and AM Stations is proof of their fine quality and versatility. They are omnidirectional. The bass end is smooth and flat. The highs are particularly clean. Each is extra rugged. Each has the exclusive E-V Acoustalloy diaphragm. Try one now—Compare it with any mike in your own studios.

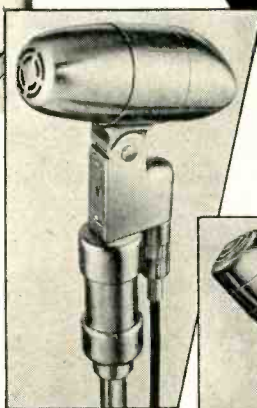

Model 645



Model 635



Model 655

Write for new Catalog No. 110 and full facts on how you can studio-test an E-V Mike.

Electro-Voice INC.

420 CARROLL ST., BUCHANAN, MICHIGAN

Export: 13 E. 40th St., N. Y. 16, U.S.A. Cables: Arlab

Microphones, Phono Pickups, Loudspeaker Systems, Self-Tuning TV Boosters

vices for use with liquid air, solid CO₂, or circulating water as constant-temperature coolants, and a window of special glass with good transmission even as far as the long wavelength limit of sensitivity attained at liquid air temperature (about 4 μ); and an experimental lead-selenide cell with sensitivity (at liquid air temperature) to cover 5 μ .

There has been investigation into the dependence of resistance and photosensitivity of lead-sulphide cells upon the surroundings with the cell maintained at temperatures down to that of liquid air. Screening the sensitive material from room-temperature radiation has been shown to give a ten-fold or more increase in resistance and also in sensitivity at temperatures near those of liquid air.

An instrument based on what is believed to be an entirely new principle in connection with the detection of smoke uses a sensitive "nose" which actuates an alarm as soon as the concentration of smoke reaches a predetermined value.

The nose contains an ionization chamber which is open to the atmosphere to be sampled. A source of radioactivity maintains the air within the chamber in an ionized condition and a potential applied across the chamber causes a small current to flow. Smoke particles entering the chamber produce a sharp variation in the current and this effect is used to actuate an electronic tube of the cold-cathode type. The alarm circuit follows conventional practice.

Modulated Photocell

In many photocell applications where the light falling on the cell is steady or only changing very slowly, it is necessary to chop the d-c signals generated so that they can be amplified by high-gain, stable a-c amplifiers. This difficulty has now been overcome by subjecting the photocell itself to an alternating magnetic field, which causes the output signal from the cell to appear as an a-c voltage, thus dispensing with mechanical aids for chopping d-c signals. Such an instrument can be made sensitive to a few microlumens and is therefore useful for the measurement of

How to be sure you get

the Best Capacitor

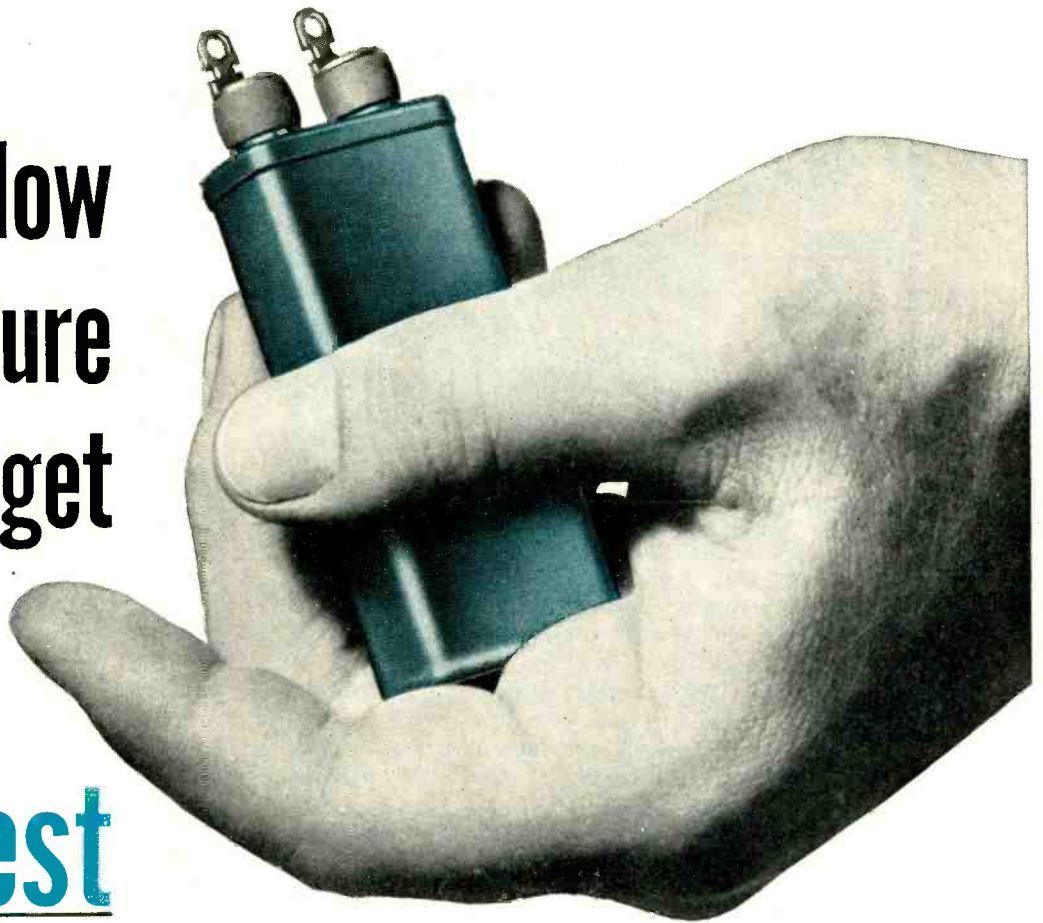

YOU CAN test the paper for density . . . thickness . . . porosity . . . power factor . . . chloride content . . . dielectric constant . . . dielectric strength.

And then test the foil for thickness . . . purity . . . softness of the anneal . . . freedom from oil . . . cleanliness of surface . . . absolute smoothness.

And then test the liquid dielectric for specific gravity . . . viscosity . . . power factor . . . color . . . acidity . . . flash point . . . dielectric strength . . . dielectric constant . . . insulation resistance . . . water content.

And after that, test every single finished capacitor for shorts, grounds, and opens at overvoltage between terminals and between terminals and case . . . and measure the capacitance of every single unit . . . and then check every single capacitor to see that it has a leak-proof hermetic seal.

OR YOU CAN buy General Electric capacitors . . . product of outstanding research and know-how . . . which have already passed every one of these tests

- . . . on the materials when they were made.
- . . . and again before they were used.
- . . . and on the capacitors during manufacture.
- . . . and then, finally, on every single capacitor before shipment.

For full information on types, ratings, dimensions, types of mounting, and prices of capacitors, address the nearest *General Electric Sales Office or Apparatus Department, General Electric Company, Schenectady 5, N. Y.*

Need square waves?

Pulse-forming networks are used where the normal capacitor discharge wave shape is not suitable, and where an impulse must have definite energy content and duration. Their design involves several tricky problems—one being suitability for high temperature operation. Nevertheless, networks are one of our specialties—we have built them by the thousands, and our experienced and capable engineers will be glad to discuss any of your design problems. We invite your inquiries.

GENERAL  **ELECTRIC**

407-170

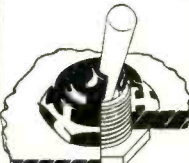
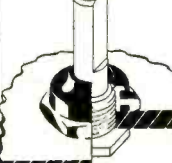
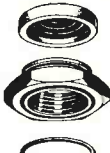
<p>for Toggle Switches Type H-1267</p> 	<p>for Push Buttons Type H-2475</p> 	<p>for Control Shafts Type H-1268</p> 
<p>NOW...FOR PENNIES...YOU CAN SEAL OUT FUMES, DIRT AND MOISTURE AT SWITCHES AND CONTROL SHAFTS WITH RFL SEALNUTS!</p> 		

HERE'S WHY . . . MATERIALS: Cap and O-Ring of flexible, close-hugging, long-wearing Neoprene • Nut of weather-resistant, nickel-plated brass • TEMPERATURE RANGES: Standard Type (+100° C to -40° C), Low Temperature Type (+100° C to -50° C) • WEATHERING CHARACTERISTICS: Unaffected by sun or moisture, SEALNUTS keep their positive seals indefinitely • OPERATING LIFE: 10,000 cycles (minimum)

MOUNT AND SEAL YOUR SWITCHES WITH LOW-COST SEALNUTS
Write for illustrated literature, or send \$2.00 for generous "Get-Acquainted Package", containing liberal assortment for control shaft, toggle and push button switches.



RADIO FREQUENCY LABORATORIES INC.

Boonton 1, New Jersey

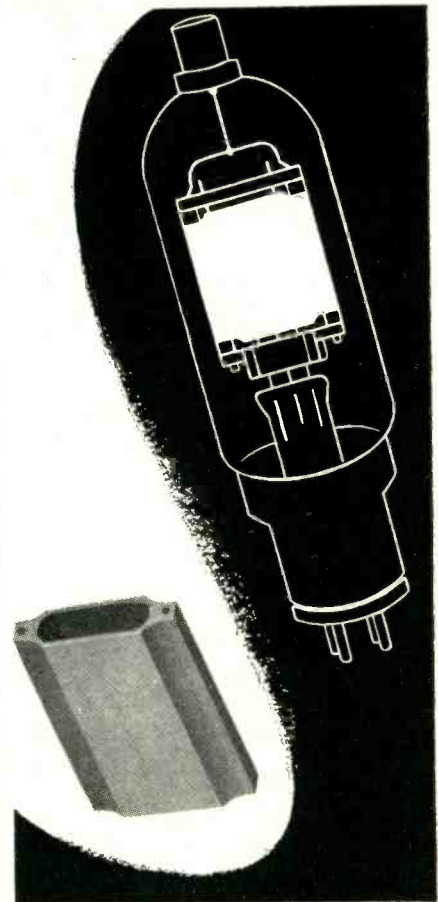

GRAPHITE ANODE TUBES CUT FREQUENCY DRIFT

Frequency drift is a major problem in modern precision electronic equipment. With Speer graphite anodes, frequency drift hits *new lows!*

Here's why: Graphite anode tubes are *non-warping*. Tube characteristics will remain uniform. Interelectrode capacitances stay constant. Warping in other tube elements is inhibited. Power ratings are raised—as high as 200 to 300 percent. Thanks to their lower operating temperatures, graphite anode tubes have exceptionally long life . . . withstand hardest usage.

Whether they're used in power, rectifier, or modulator vacuum tubes, Speer graphite anodes are instrumental in bringing increased efficiency to modern electronics. Rectifiers, FM and short wave transmitters, diathermy, and many other types of equipment give better service—thanks to the tube with the graphite anode.

Speer 
CARBON COMPANY
ST. MARYS, PENNA.

ZOPHAR

Waxes, Compounds and Emulsions



Materials for potting, dipping or impregnating all types of radio components or all kinds of electrical units. • Tropicalized fungus proofing waxes. • Waterproofing finishes for wire jackets. • Rubber finishes. • Inquiries and problems invited by our engineering and development laboratories.

Zophar Mills, Inc. has been known for its dependable service and uniformity of product since 1846.

ZOPHAR MILLS, Inc.

ESTABLISHED 1846

117 26th STREET, BROOKLYN 32, N. Y.

Get more from your test equipment with **RCA ACCESSORIES**

NEW RCA High-Voltage Probes—WG-289, WG-290
Extend dc voltage range of your instrument to 50 kv.

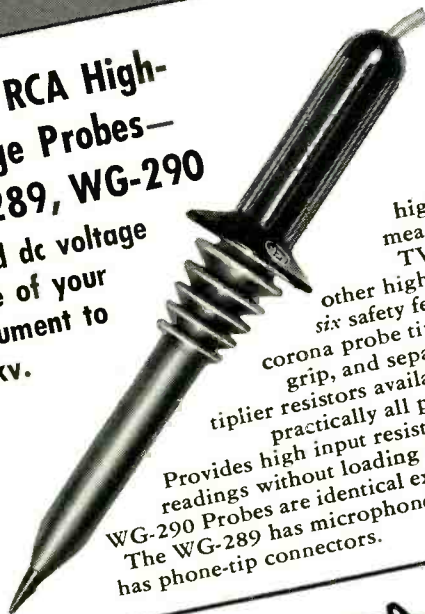

Only \$9.95
Complete with resistor.
Suggested User Price.

The last word in high-voltage probes for measuring the voltage of TV power supplies and other high-voltage sources. Has six safety features, including anti-corona probe tip, completely insulated grip, and separate ground lead. Multiplier resistors available to adapt probes for practically all popular volt-ohm-meters. Provides high input resistance for accurate voltage readings without loading circuit. The WG-289 and WG-290 Probes are identical except for their connectors. The WG-289 has microphone-type connector; WG-290 has phone-tip connectors.

NOW... the RCA TV Isotap WP-25A—
A combination Isolation-Autotransformer for Television Servicing



Only \$17.95 Suggested User Price.
The answer to safe, accurate and speedy servicing of TV receivers... the RCA WP-25A TV Isotap provides *normal line voltage* for testing sets against manufacturer's rated specifications... *high line voltage*... *low line voltage* to test intermittents and faulty components... *line isolation* to prevent shorts, receivers under conditions similar to those found in some customers' homes... *line matching* to prevent shorts, shocks, and damage to test equipment... *500 volt-amperes continuous output* from autotransformer winding; or 275 volt-ampere load from isolated secondary winding.

RCA WG-263 CRYSTAL PROBE

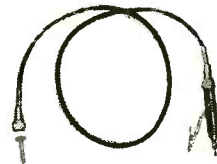

Converts VoltOhmyst* Meters 163, 165, 165-A, 195, 195-A, WV-65A, WV-75A, and WV-95A into VHF voltmeters for use up to 100 Mc; also used with Chanalyst* Analyzers Types 162, 162-A, 162-B, 162-C and 170-A. Can be used for relative readings to 175 Mc. Price: \$8.95.
*Trade Mark, Reg. U. S. Pat. Off.

RCA WG-275 DIODE PROBE



Designed to operate with RCA Volt-Ohmyst* Electronic Meters WV-75A or WV-95A, for reading rms or peak-to-peak voltages at frequencies from 30 cycles to 250 Mc. The probe fits coaxial "T" connectors, and permits direct measurement of voltages in coaxial lines. Price: \$30.00.
*Trade Mark, Reg. U. S. Pat. Off.

RCA WG-265 MINIATURE TESTPOINT ADAPTER



Makes your troubleshooting faster, easier, safer by making tube-base connections accessible on the tube side of the chassis. Pins on one end of the adapter fit a 7-pin miniature socket, and socket facilities on the opposite end accommodate all types of 7-pin miniature tubes. Tabs project for easy probe contact. Price \$1.50.

RCA ISOTAP WP-24A FOR RADIO SERVICING



Eliminates shock hazard between ac/dc chassis and ground, speeds detection of receiver faults with high-low line tests, and facilitates testing at 117-volt design-center value. Has six-position primary switch and three secondary receptacles. Price: \$8.95.

RCA WS-18A RACK-ADAPTER PANEL

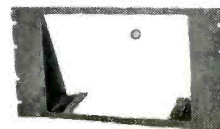

For mounting any of the matched RCA Test Instruments in standard 19-inch relay racks. Dimensions, 10½" high, 19" wide, ½" thick. Price: \$9.50.

AVAILABLE FROM YOUR RCA TEST EQUIPMENT DISTRIBUTOR



RADIO CORPORATION of AMERICA
TEST EQUIPMENT

HARRISON, N. J.

Which IONIZATION GAUGE is best suited to your HIGH VACUUM SYSTEM?



HK 5991 (VG-100)

Because of its construction all elements of the HK-5991 are very easy to degas. It offers completely stable operation and precise measurement. Sensitivity is about 75 microamps per micron. Elements are made of tungsten. Tubulation may be up to $\frac{3}{4}$ " O.D.



HK 5990 (VG-54)

This is the most sensitive HK ionization gauge . . . rated at about 200 microamps/micron with the grid drawing 5 milliamps. Plate and grid are made of tantalum. The Nonex tubulation is $\frac{7}{16}$ " O.D.



HK 5989 (VG-24G)

The HK-5989 is rated in air at about 50 microamps/micron with the grid drawing 10 milliamps. Has tantalum grid and plate. Tubulation is $\frac{5}{16}$ " O.D.

HK 5988 (VG-2)

The HK-5988 is one of the most widely used ionization gauges. Its sensitivity in air is about 25 microamps/micron with the grid (accelerator) drawing 5 milliamps. Grid and plate (collector) are nickel. Tubulation is $\frac{5}{32}$ " O.D.

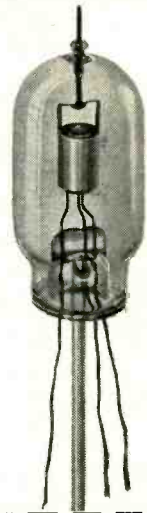

Send for this FREE Manual

THE USE OF IONIZATION GAUGES IN HIGH VACUUM SYSTEMS

This new publication thoroughly covers the uses of high vacuum triode ionization gauges . . . for ultra-centrifuges, cyclotrons, vacuum spectrographs, metal evaporating and coating systems, vacuum furnaces, high vacuum drying of organic materials, etc. Write for your copy of this manual. It's free.



HEINTZ AND KAUFMAN DIVISION

 THE ROBERT DOLLAR CO. REDWOOD CITY, CALIF.

Export: M. SIMONS & SON CO., Inc.
25 Warren Street, New York City
Cable: SIMONTRICE

density of films, infrared radiation and similar applications.

A recent British patent has disclosed that a variable permittivity dielectric can be made from a mixture of barium and strontium titanates in the ratio of 95 to 5, permittivity increasing as an applied alternating voltage is increased. This property can be utilized in various ways in electronic circuits by making capacitors which are voltage-sensitive and can thus be used to secure automatic selectivity or frequency control.

For example, if the two circuits of an interstage coupling of the bandpass type are precisely in tune for a given signal level, the progressive detuning of the circuit as the signal increases above this level can be achieved by including one of these new capacitors in the circuit. The detuning will automatically widen the acceptance band of the filter and can be made to give constant selectivity.

Fifteen C-R Tube Camera

A development in the cathode-ray tube field is a fifteen-channel crt camera with fifteen $1\frac{1}{2}$ -inch built-in tubes as an integral part of the unit. The tubes are mounted so that eight are on one side of the camera and seven on the other, with the screens of the tubes facing in the same direction as a pair of 3-inch f.2.9 lenses.

The latter are mounted at an angle of 36 degrees to each other and adjustable mirrors (one for each tube) are arranged in two batteries to reflect the traces on the fluorescent screens accurately along the axis of each lens. The traces are focused on a vertical zero line and the tubes are staggered to permit fifteen traces on a 70-mm film. Each trace is 7.5 mm wide, being reduced from one inch (25.4 mm) on the cathode ray screens and the dispositions on the film are such that the extremities of any of the traces belonging to the seven-tube group are on the midpoint of the neighboring traces of the eight-tube group.

Integral with the camera are two argon-filled discharge lamps which can be operated from an external circuit to give time marks on the film. One mark, in the form of a

now color tv for industry!

THE DU MONT TA-164A CLOSED CIRCUIT INDUSTRIAL COLOR TV SYSTEM



Now available! The Du Mont tried-and-proved industrial color television system in a complete, packaged, ready-to-operate form. Designed specifically for industrial applications, the new Du Mont TA-164A Industrial Color TV System provides bandwidth of 18 mc. and picture resolution of 525 lines. Full high-fidelity color from light pastels to deep colors.

Engineered to provide dependable day-in day-out service required by industry, research, medicine, merchandising and countless other fields. Compact, lightweight, portable units are joined by interconnecting cables utilizing the famous Du Mont "Jiffy" connectors assuring complete flexibility and the Du Mont kind of dependability. May be plugged into power line anywhere. Operates on 110-volt 60-cycle AC.

► DETAILS ON REQUEST

DUMONT



First with the Finest in Television ALLEN B. DUMONT LABORATORIES, INC.
Television Transmitter Division, Clifton, N.J.

DO YOU KNOW?

— that a **PILOT LIGHT**
CAN IMPROVE YOUR PRODUCT
... add attraction — safety — service?

Ask

DIALCO

- what lamp to use
- how to use it
- what it will do
- what it will cost

THIS MAY BE THE ONE
Designed for low cost NE-51 Neon

- Built-in Resistor • Patented
- U/L Listed • Rugged

 Catalogue Number 521308 — 997
for 110 or 220 volts.



SAMPLES
for design purpose
NO CHARGE

NEW! Write for the
"HANDBOOK OF PILOT LIGHTS."

Write us on your design problems.

The DIAL LIGHT COMPANY of AMERICA

Foremost Manufacturer of Pilot Lights.

900 BROADWAY, NEW YORK 3, N. Y. TELEPHONE SPRING 7-1300

dependable instruments

Heiland
DENVER

**Fully Portable
Self Contained**

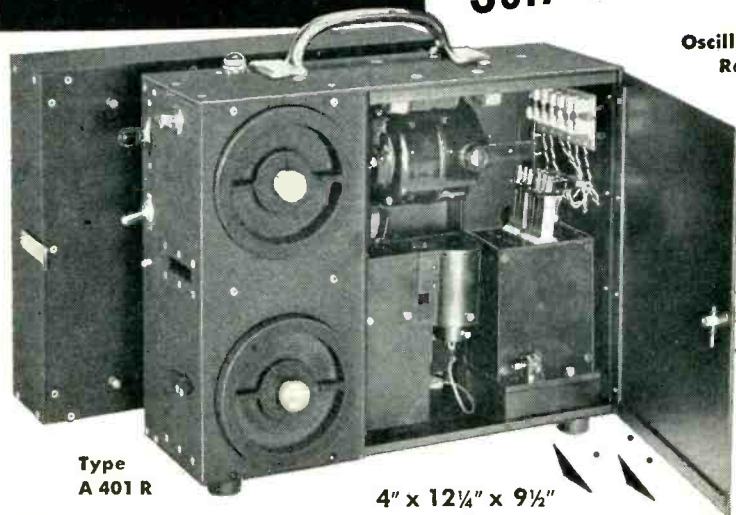

Oscillograph
Recorder

Type
A 401 R

4" x 12 1/4" x 9 1/2"

Optional 8 volt battery pack provides self contained power source affording maximum flexibility of application and portability.

Weight with battery pack, 39 lbs.;

recorder only, 22 lbs. Size with battery pack 7" x 12 1/4" x 9 1/2". Maximum of 6 channels. Paper 2" wide, 100' long. Available without battery pack for operation on 12 or 24 volts D.C.

Write for complete details

HEILAND RESEARCH CORPORATION • 130 East Fifth Ave. • Denver, Colo.

This
EDISON RELAY
is sensitive...
but only to
MICRO-CURRENTS



Sensitive is about the only word that can describe a relay which will operate on input powers as low as 25 micro-watts. Sensitivity also suggests lack of strength, but that's not true in this case. Electrically this Sensitive Relay will continuously withstand input powers 10,000 times its nominal ratings, and mechanically it's truly rugged. Originally developed for aircraft use, it is standard equipment on thousands of planes in the air today.

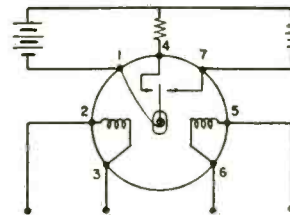

Schematic showing how coil leads are brought out to separate contacts in the relay base, permitting differential operation.

HOW YOU CAN TAKE ADVANTAGE OF THESE FEATURES

Sensitivity of this degree makes this relay well suited as a dependable circuit actuator for use directly with low output detectors, such as thermocouples, photocells, etc. It may be used for polarized or differential operation, as a null-seeking device, etc. Contacts SPST or SPDT, normally open or closed. Seated height, 2 1/4"; dia. 1 1/8"; weight 68 grams; 7-pin small radio tube base.

Full information available. Write for Bulletin 3004-D.
184 Lakeside Avenue, West Orange, N. J.



INSTRUMENT DIVISION

THOMAS A. EDISON, INCORPORATED
WEST ORANGE, NEW JERSEY

For the Answer to Your Insulation Problem

Look Through *this* Line...



● Can't guarantee that the Varflex Line will solve every insulation problem. But . . . Many's the problem—large, small, unusual—that Varflex Electrical Sleeving or Tubing has solved. The Varflex range of application is vast—chances are you'll find the solution to your Electrical insulating problem somewhere in the Varflex line.

● **VARGLAS SILICONE.** That's the insulating sleeving and tubing—pioneered by Varflex—that takes temperatures ranging from 500° F above to 85° F below in its efficient, resistant stride. Lead wire and treated cord too.

● **VARGLAS TUBING IMPREGNATED WITH GENERAL ELECTRIC PERMAFIL.** Tough, flexible, heat-resistant—available in coils. Premium tubing at a reasonable price.

● **VARGLAS SLEEVING AND TUBING.** Numerous types and grades—including synthetic treated, varnished, lacquered, saturated, litewall and others.

● **VARGLAS NON-FRAY SLEEVING.** Three types—may be subjected to temperatures up to 1200° F—for applications where dielectric requirements are not primary.

● **VARFLO TUBING AND SLEEVING.** New, low-priced — for applications where unusually high temperatures are not a factor. A real economy line, this.

● **VARFLEX COTTON TUBING AND SLEEVING.** Varnish or lacquer impregnants — for applications where Fiberglas products are not required.

● **SYNTHOLVAR EXTRUDED PLASTIC TUBING.** Low temperature flexibility—high dielectric and tensile strength—made from a standard formulation of vinyl polymers.

SAMPLES? All you want with our compliments. For free folder of our complete line, just clip and mail this coupon.



**VARFLEX
CORPORATION**

**MAKERS OF ELECTRICAL INSULATING
TUBING AND SLEEVING**

VARFLEX Corporation, 308 N. Jay St., Rome, N. Y.

Please send me information as well as free samples of your electrical Sleeving and Tubing.

I am particularly interested in samples suitable for.....

Name.....

Company.....

Street.....

City..... Zone..... State.....



**WIRES—
MEASURED,
CUT AND STRIPPED
AUTOMATICALLY—
FAST
AT
LOW COST**

This
**IS WHAT YOU GET BY
USING ARTOS AUTOMATIC
MACHINES**

- ① CUT WIRES FROM 1" TO 60' IN LENGTH
- ② STRIP UP TO FIVE INCHES
- ③ HANDLES WIRES FROM 26 GAUGE TO 000 GAUGE

Applications of Artos Machines throughout the automotive, radio, telephone, and electrical appliance industries have the economy-improving, efficiency-increasing values of fully automatic cutting, measuring, and stripping of wires. AND, terminals can also be put on one end, AUTOMATICALLY, IN THE SAME OPERATION!

Artos machines are available in a variety of models. There is probably one to meet your exact requirements, in either bench or floor models.

Make it a point to find out how Artos machines can improve your production. Write on company letterhead today for complete information.

**ARTOS
ENGINEERING CO.**

DEPT. EL, 2739 S. TWENTY-EIGHTH STREET
MILWAUKEE 7, WISCONSIN

small dot on the edge, can represent a chosen time interval and the other, a thin line across the whole film, can indicate a recurrent external event.

One particularly interesting use has been in the construction of a fault recording unit for the British Electricity Authority. This apparatus is made to record the faults on power lines and by the use of auxiliary apparatus is arranged to be normally in a quiescent state. When a fault occurs, the camera motor is started and the crt beams switched on to record all waveforms. Then after the restoration of steady conditions, it closes down again and at the same time recording the date and time of the occurrence.

Low-Frequency Analyzer

For some time there has been a need for an instrument by which aircraft engines can have their vibration modes analyzed and the engine speed shown simultaneously. The difficulty has been that the range of frequencies to be examined is considerably below the range of wave analyzers which give automatic and continuous records.

A new British low-frequency analyzer is arranged to scan continuously the frequency range from 6 to 400 cps. Six modulator circuits are incorporated to cover the bands 6-12.5, 12.5-25, 25-50, 50-100, 100-200 and 200-400. Scan for the channel bands takes place in 1/25 second and to provide a continuous scan the modulator frequency for each band is varied over the octave once in 5 seconds. This results in the analysis being spread from a row of plain lines to a continuous area, the boundary of which gives the amplitude distribution of the complex wave.

To obtain a high degree of resolution it is best if the fifth and sixth bands are displayed downwards on the cathode ray tube, below the first and second bands.

In practical use, the luminous area on the screen, something like an a-c waveform in appearance, is not solid but is shown as a number of bands corresponding with the obviously limited number of frequencies present, the width of the bands being a measure of the variation of these frequencies with time.

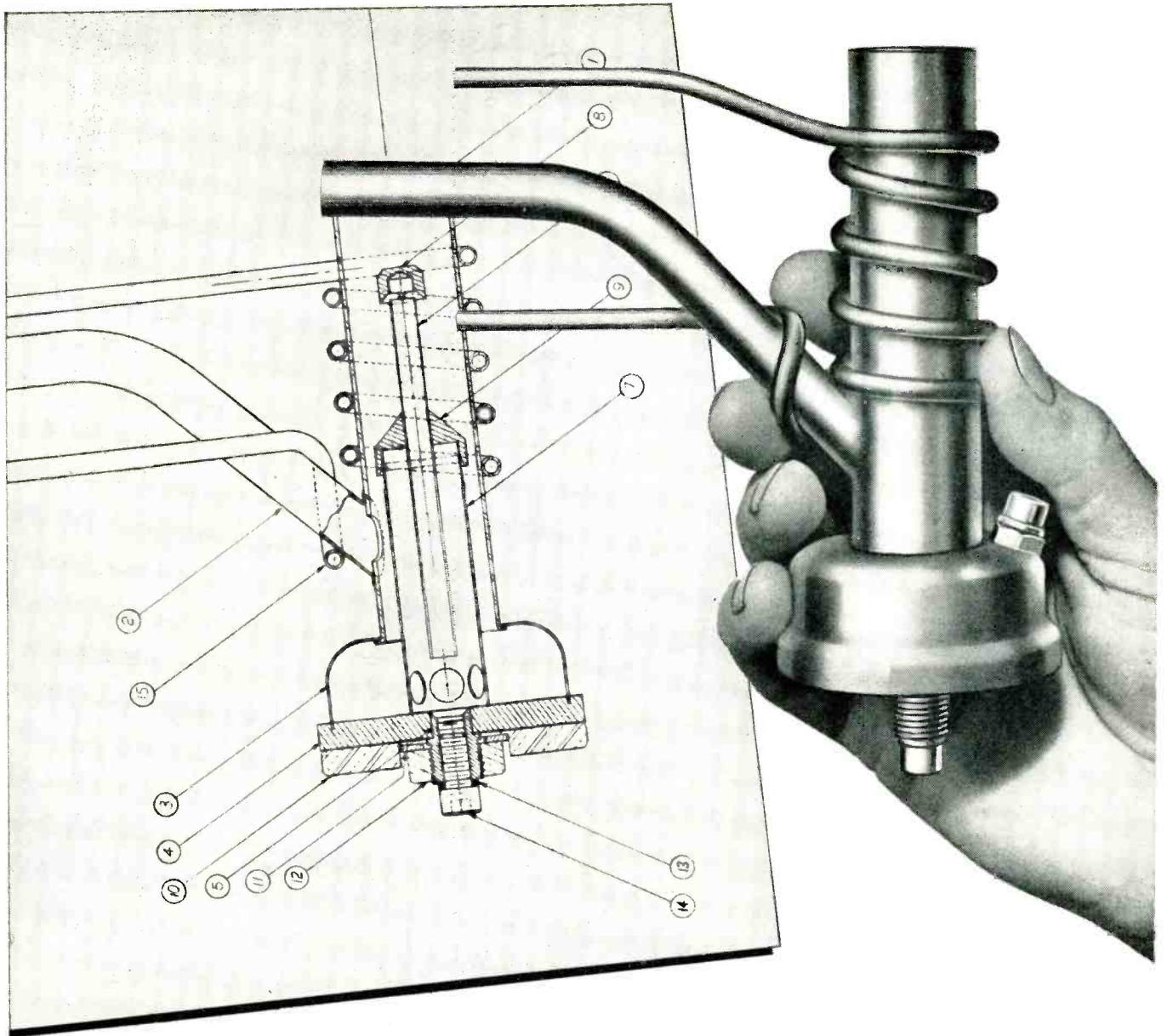

New Booster Pump reduces the exhaust cycle of rotary units

This tiny booster pump was specially designed to increase the efficiency of rotary exhaust units. It is able to produce a total pressure of 0.5μ , or less, in one-half the time of other available equipment because it has high pumping speed in the *right range of pressure*. It is ideally small — only $2\frac{1}{2}$ " in diameter by 6" long. You'll have

no trouble mounting it at each exhaust port on most rotary equipment.

Because of its speed, this new diffusion pump can cut your exhaust cycle. At the same time, it gives the higher vacuum needed in the production of better quality tubes. Write today for complete information.

INDUSTRIAL RESEARCH • PROCESS DEVELOPMENT
HIGH VACUUM ENGINEERING AND EQUIPMENT



METALLURGY • DEHYDRATION • DISTILLATION
COATING • APPLIED PHYSICS

National Research Corporation

Seventy Memorial Drive, Cambridge, Massachusetts

In the United Kingdom: BRITISH-AMERICAN RESEARCH, LTD., London S.W. 7 — Wishaw, Lanarkshire

Try these new, low cost
diffusion pump fluids . . .
Narcoil 10 • Narcoil 20
Narcoil 30

INTERCHANGEABLE MOTORS FOR ALL TIMING APPLICATIONS

A.C. Synchronous and D.C. Governed or Variable Speed

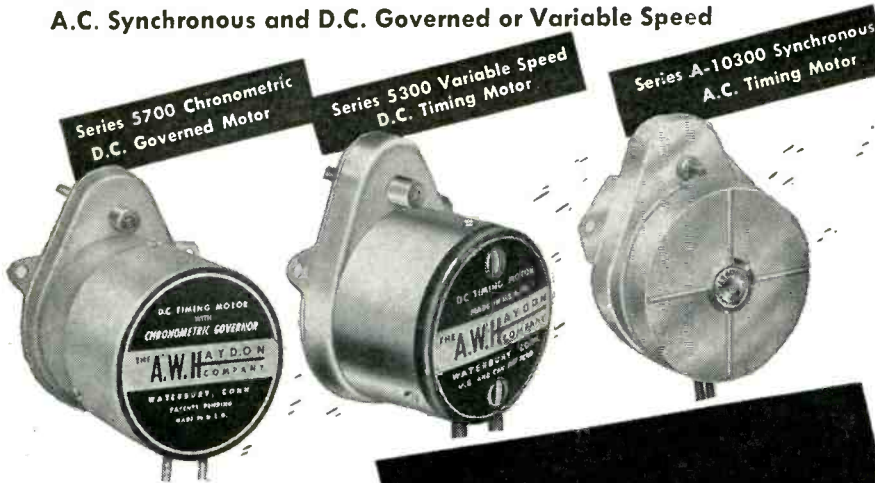

Standardize your timing motors. The A. W. Haydon Co. is the only supplier of interchangeable A. C. Synchronous and D. C. Chronometric governed or variable speed motors for precision time keeping.

Make A. W. Haydon your primary motor source for —

- A.C. — Synchronous
 - D.C. — Governed
 - D.C. — Variable Speed
- TIMING MOTORS**

THE A.W. HAYDON COMPANY
 235 North Elm Street, Waterbury 32, Connecticut
 Design and Manufacture of Electrical Timing Devices

EISLER Television Tube MACHINERY

- ECONOMICAL
- MODERN DESIGN
- PRODUCTION ENHANCING

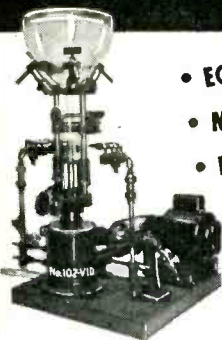

EISLER'S Electronic Equipment is especially Designed and Built to your exact requirements.
 From 5" to huge 24" Television Tube

EISLER specializes in GLASS WORKING MACHINERY for the manufacture of: Cathode Ray; Radio Tubes (Standard, Miniature, Sub Miniature); Fluorescent Lamps; Glass Ampoules; Vials; Incandescent Lamps.

- Consultation without any obligation on your part is cordially invited.

EISLER ENGINEERING CO., INC.
 751 SOUTH 13th ST. • NEWARK 3, NEW JERSEY

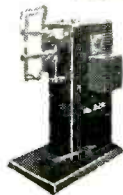
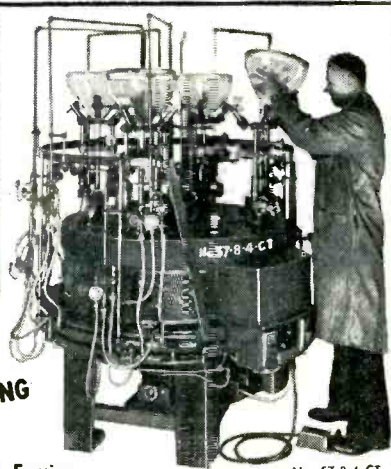

RESISTANCE WELDERS
 •
 1/4 to 300 KVA



EISLER TRANSFORMERS
 STANDARD • SPECIAL
 Air, Oil or Water Cooled
 •
 Sizes From 1/4 to 500 KVA

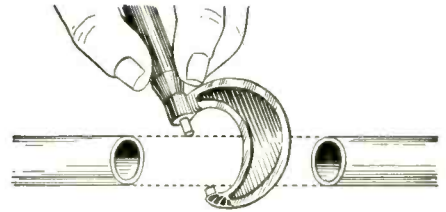

**Form to form
 THEY'RE UNIFORM**

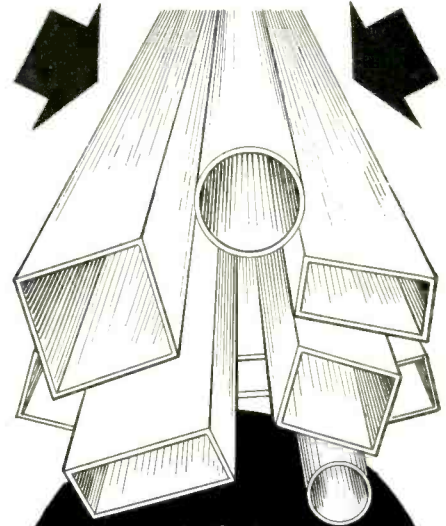

**PRECISION
 paper
 TUBES**

Die-formed under heat and pressure, each Precision Paper Tube is exactly the same as every other Precision Paper Tube that is made to the same specifications. This form-to-form uniformity helps assure more accurately-wound coils. Moreover, Precision Paper Tubes are made of finest dielectric Kraft, Fish Paper, Cellulose Acetate or combinations. Better heat dissipation, greater moisture resistance, and lighter weight are the results.

Let us make up a FREE sample for you!

We make Precision Paper Tubes precisely to your specifications. Any length, any size, any shape — round, square, oval, rectangular.

Write today for new mandrel list of over 1,000 sizes.

PRECISION PAPER TUBE CO.

Also makers of Precision Coil Bobbins
 2041 W. Charleston St., Chicago 47, Ill.
 Plant #2
 79 Chapel St., Hartford, Conn.

ANNOUNCING

A NEW INDUCTION MOTOR-GENERATOR

• • • The first of its kind to be included in the wide range of "Brain Block" components now available for private industry.

ARMA Type 1A400

• • • A precision unit for high performance instrumentation and control applications.

ITS TYPICAL CHARACTERISTICS INCLUDE:

MOTOR — With 115 volt, 400 cycle excitation on both main and control fields.

Stalled	
Power Input	16.5 watts max. per phase
Impedance	210+j 380 ohms approx.
Torque	1.5 oz. in. minimum
Running — No Load	
Power Input	7 watts per phase approx.
Impedance	160+j 530 ohms approx.
Speed	8500 R.P.M. min.

GENERATOR — With 115 ± 1 volt, 400 ± 0.1 cycle excitation.

Input current	0.065 amp.
Input power	2.8 watts
Max. speed for specified performance	6000 R.P.M.
Output — Nominal	0.1 volts per 100 R.P.M.
Output — Standardized at 25°C, 3600 R.P.M., 750 mmfd. load	
Magnitude	3.600 ± .05% volts
Phase Angle	10' ± 5' (lagging)
Max. Linearity Deviation	
Magnitude (in % specified max. speed)	
Over range 0-4000	0.04% (1.5 R.P.M. or 1.5 m.v.)
Over range 4000-6000	0.15% (8.5 R.P.M. or 8.5 m.v.)
Quadrature	
Over range 0-4000	1.0 m.v.
Over range 4000-6000	5.0 m.v.
Effect of ambient temperature	change from 15° to 70° C.
Variation in magnitude	approx. 0.07% max.
Variation of phase angle	approx. 0.5 min. per degree
Zero Speed-Residuals	
In-phase:	approx. 3 m.v. max.
Quadrature:	approx. 3 m.v. max.
Harmonics:	approx. 7 m.v. max.

PHYSICAL CHARACTERISTICS

Rotor inertia 0.75 oz. in. ²
Weight (inc. auxiliary unit) 3¼ lbs.

Static friction — with main field excited, motor control field voltage required to start unit does not exceed 2.8 volts.

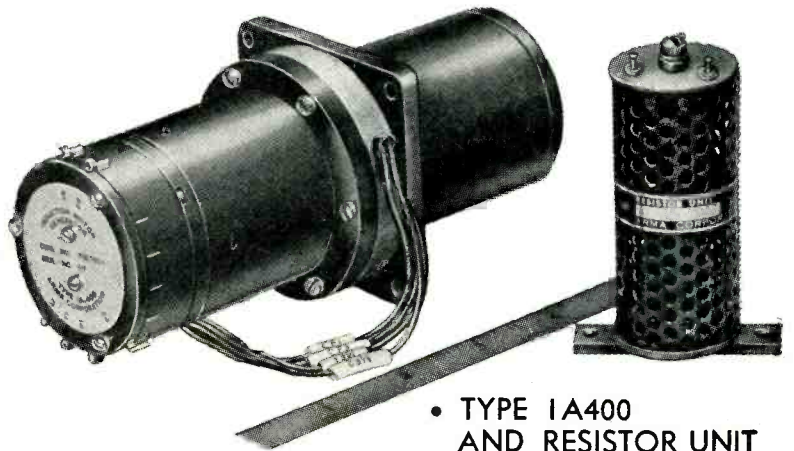

• TYPE 1A400 AND RESISTOR UNIT

OUTLINE DRAWINGS
AND EXACT MEASUREMENTS
ARE INCLUDED IN NEW
BOOKLET JUST PRINTED—
ASK FOR A COPY

ARMA CORPORATION

254 361^h STREET, BROOKLYN 32, N. Y.

SUBSIDIARY OF AMERICAN BOSCH CORPORATION

ARMA
PRODUCTS
RELEASED
FOR
PRIVATE
INDUSTRY

ARMA ELECTRICAL RESOLVERS • ARMA SYNCHROS • ARMA INDUCTION MOTORS • ARMA INDUCTION GENERATORS • ARMA MECHANICAL DIFFERENTIALS • ARMA ALTERNATING VOLTAGE COMPARATOR • COMPUTING MECHANISMS • INDUSTRIAL CONTROLS • STABILIZATION DEVICES • NAVIGATIONAL EQUIPMENT • LIMITRON AUTOMATIC INSPECTION SYSTEM

* Licensed for use under Arma patents Nos. 2,465,624 and 2,467,646. License information available.

QUALITY **ARMA** PRECISION
INSTRUMENT

SEE·MEASURE·RECORD

UP TO 10 transients at the same instant

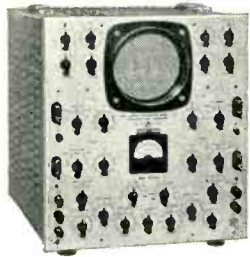
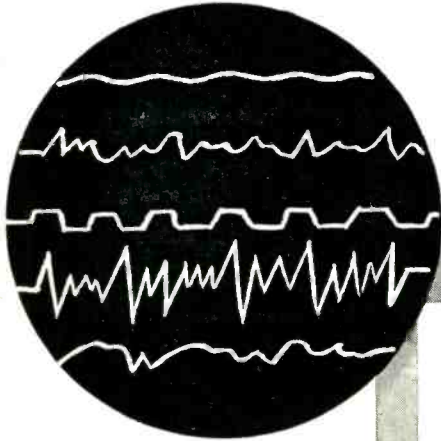

H-21 DUAL CHANNEL OSCILLOSCOPE. Sensitivity better than 0.085 Vdc/in (30MV rms/in)

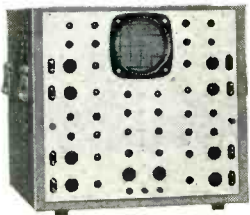

H-45 FOUR CHANNEL OSCILLOSCOPE. Any combination of four DC or AC amplifiers, DC to 1 megacycle.

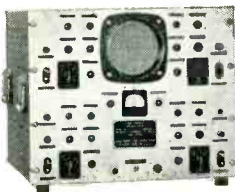

H-43 FOUR CHANNEL OSCILLOSCOPE. For recording through continuous strip cameras like the Fairchild Oscillo-Record F-246A.

A signal from the brain and a man ducks, blinking his eyelashes. A huge bomber takes a load under various static and dynamic conditions and a multitude of strain lines take different characteristics. Electricity passes through electronic apparatus and emanates with different voltage, current, and phase relationships.

Observing simultaneous quantities like these—in testing, production, and research—proves the value of ETC multi-channel oscilloscopes every day. No other equipment can give you such correct time relationships for a number of simultaneous phenomena. No other equipment saves you the array of instruments and varying test procedure required by other means of coincident analysis. Write today and find out how you can save time, money, and trouble using ETC oscilloscopes, amplifiers, and tubes.



MULTI-GUN CATHODE RAY TUBES. 2, 4, 6, 8, and 10 gun tubes, potentiometer and radial deflection tubes.



electronic tube corporation

PHILADELPHIA 18, PENNSYLVANIA

THE ELECTRON ART (continued from p 122)



Comparison of sizes of 10- μ f, 150 wvdc hermetically sealed paper capacitors with conventional (left) and metallized construction

sulation resistance does not affect performance.

When dielectric weaknesses and incipient faults develop in a metallized paper capacitor due to conducting particles or if a momentary surge of voltage should puncture the dielectric, the selfhealing action functions to clear the short, and the capacitor continues to operate normally in the circuit without interruption. This selfhealing cycle may occur thousands of times without affecting the life of the capacitor.

Design Engineering Data

The metallized paper capacitor is ideally suited for use where space is at a premium, as in equipment for military and industrial use. It is not recommended for certain special applications demanding high-impedance capacitors, such as those used in photoflash and timing circuits where the R-C curve is used to trigger electronic circuits. On the other hand, the metallized paper unit has a lower r-f impedance than an equal-value conventional paper unit since it has a lesser number of turns and shorter current path. This makes it ideally suited for r-f filters in noise suppression systems, particularly in aircraft applications and portable equipment for military use where minimum size and weight are essential prerequisites.

Typical applications for which metallized capacitors are ideally suited include, r-f and audio bypass circuits, filters, power factor cor-

WORLD'S FINEST Hermetic Seals

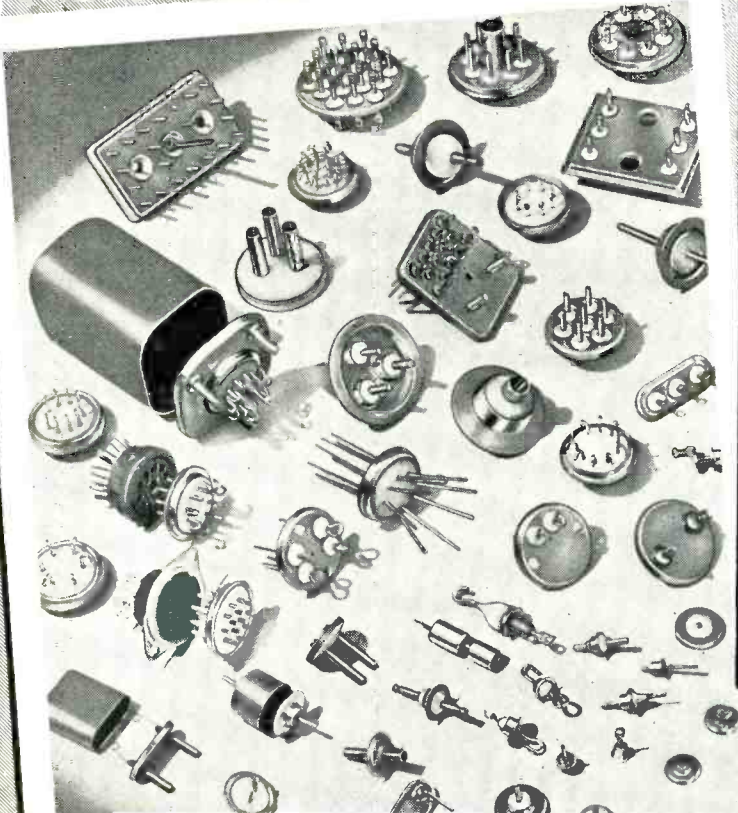

The Only Seals
You Can Hot Tin Dip
at 525° F. for Easy
Assembly Soldering,
for a Strain and
Fissure-Free Sealed
Part with Resistance
of over
10,000 Megohms!

America's leading industries and government agencies have made Hermetic Seal Products Company headquarters for glass-metal headers that are impervious to every element, even under the most adverse conditions.

Hermetic headers withstand high vacuum, high pressure, temperature cycling, oils, compounds, chemicals and corrosion.

TERMINALS AND HEADERS ARE AVAILABLE IN RMA COLOR CODE

No matter what your requirements are in design or production runs, Hermetic's creative engineering and amazingly flexible processing will save you time, money and effort and will turn out hermetic seals of unrivaled quality for the ultimate in performance.



Your copy of the most complete catalog ever produced on hermetic seals is available without cost or obligation. Here, in 16 data-laden pages, is the most thorough presentation of factual material on hermetic seals. Write for your copy. Let us know how we can help solve your problems in hermetic sealing.

HERMETIC SEAL PRODUCTS COMPANY 29-37 So. 6th St., Newark 7, N. J.

THE
HEADER SEAL
GUARANTEED
IMPERVIOUS
TO EVERY
ELEMENT!

See our display at the National Electronics Conference at the Edgewater Beach Hotel, Chicago. September 25, 26 and 27th. Booth #43.



for
**Precision
Wire Wound Resistors**

RPC Resistors are high quality units designed to meet the most stringent requirements. They are widely used in large quantities by laboratories, instrument manufacturers, and the Armed Forces and their suppliers. Sizes available are in accordance with JAN-R-93, RB10 to RB14. Terminals may be wire leads if required. Resistance tolerance to 0.02% is available. All resistors are wound with special low temperature coefficient alloy wire at no additional cost. Quick delivery is a feature of our service to you. Write today for catalog.

Also manufacturers of High Voltage Resistors, High Megohm Resistors and High Frequency Resistors.

rpc RESISTANCE PRODUCTS CO.
714 RACE STREET • HARRISBURG 2, PA.

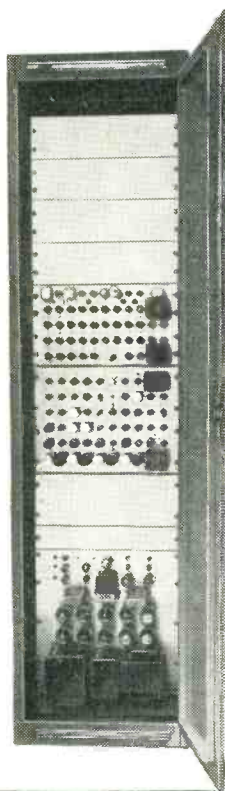

**NEW TYPE 2200
SYNCHRONIZING
SIGNAL GENERATOR**

Featuring:

A new high for stability, performance, versatility.

- All binary dividers. No blocking tube or locked oscillators. Complete freedom from "rolling" at critical moments.
- All waveforms keyed from pulses derived from precision delay line. Absolute stability is achieved.
- Meets all RMA and FCC specifications with wide margin to spare.
- Built-in bar and dot generator for sweep linearity checking.
- Furnished with cabinet and has 33 1/4" mounting space available for type #2300 monoscope camera or other uses.

Price Complete
with Cabinet
\$1995. F.O.B. PLANT

Write for Type 2200
Data Sheet for Full
Details



Manufacturers of a Complete Line of TV Test Equipment
Tel-Instrument Co. Inc.
50 PATERSON AVENUE • EAST RUTHERFORD, N. J.

Where the
Requirements
are Extreme...

Use
**SILVER
GRAPHALLOY**

For extraordinary
electrical performance



THE SUPREME BRUSH
AND CONTACT MATERIAL

IN BRUSHES

- for high current density
- minimum wear
- low contact drop
- low electrical noise
- self-lubrication

IN CONTACTS

- for low resistance
- non-welding character

SILVER GRAPHALLOY is a special silver-impregnated graphite

Accumulated design experience counts — call on us!

**GRAPHITE METALLIZING
CORPORATION**

1055 NEPPERHAN AVENUE, YONKERS 3, NEW YORK

are businessmen

COLD-

BLOODED?



OF COURSE NOT! Literally, their normal body temperature is 98.6—same as laborers, engineers or any other group of people. And, figuratively, they're no more, or no less, cold-blooded—as a group.

We all know unreasonable generalizations can be dangerously false. Common sense and on-the-job experience show us the value of dealing specifically with ideas, problems—and *people*.

Let's not make the big—and costly—mistake, then, of generalizing on religious or racial groups. Adopt and *carry out* these common sense principles:

1. Accept—or reject—people on *their individual worth*.
2. Don't listen to or spread rumors against a race or a religion.
3. Speak up, wherever we are, *against* prejudice. Work for understanding.



Published in the public interest by:

McGraw-Hill Publications

FOR **HIGH-SPEED** PULSE WORK and study of complex wave forms with vhf components

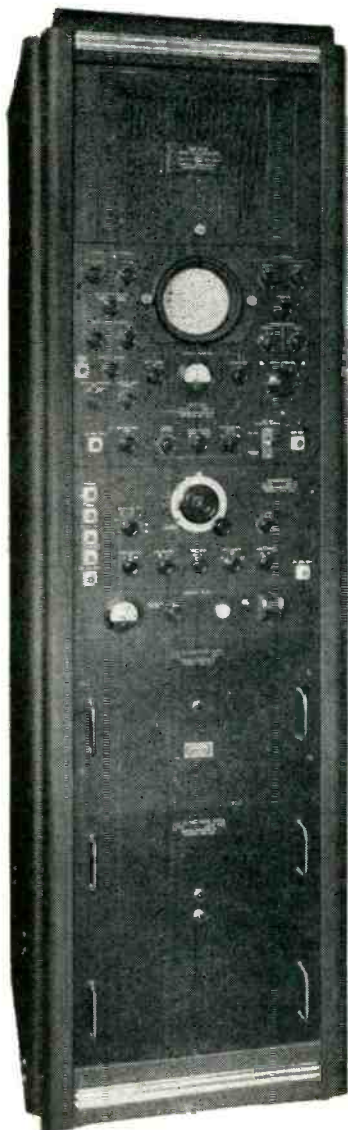

Size: 81³/₈"x25⁵/₈"x24"
Weight: 500 lbs;
shipping weight: 750 lbs.
Request Bulletin EL-17 for
complete specifications.

In Canada, address:
Measurements Engineering Ltd.
Auriprior, Ontario.

Export Sales: 9 Rockefeller Plaza, Rm. 1422,
New York 20, New York



ENGINEERED
FOR
ENGINEERS

Browning WIDE-BAND OSCILLOSYNCHROSCOPE MODEL OJ-17

'Scope, synchronizer, high-voltage power supply, low-voltage power supply, and control panel are mounted in a vertical rack cabinet on casters. Provision is made for installation of a Fairchild Oscillo-record camera when photographic records of 'scope traces are desired.

CIRCUIT FEATURES

- **Vertical amplifier:** band width flat to 16 mc; response extends beyond 30 mc; maximum deflection sensitivity .05 volts/inch; video delay circuit, 0.2 micro-second delay.
- **CR Tube:** Type 5 RP or 5 XP; anode voltage variable 10-20 KV.
- **Driven Sweep:** variable .05-500 micro-seconds per in.
- **Sawtooth Sweep:** 5-500,000 c.p.s.
- **Trigger Generator:** output of 100 volts from 500 ohms, running rate 20-20,000 c.p.s.
- **Markers:** internal blanking or deflection type: 0.1, 1, 10, 100 micro-second intervals.
- **Beam Intensity Modulation:** external connection to grid.
- **Variable Delay Circuit:** provides positive and negative delayed output triggers. Delays sweep from external sync. or internal trigger generator. Continuously variable to 2000 micro-seconds by means of directly calibrated dial.
- **Voltage Calibration Circuit:** for measurement of input signals by substitution voltages in form of 60-cycle square waves.

BROWNING
Laboratories, Inc.
Winchester, Mass.

rections up to 500 cps, motor starting up to 500 cps, and noise suppression systems. They are not recommended for photoflash work, coupling circuits and timing circuits requiring constant R-C curves.

Insulation Resistance

In general, the insulation resistance of metallized paper capacitors is lower than that of the foil and paper types. To a large extent, this is due to the fact that the working stresses employed are considerably higher, since advantage is taken of the selfhealing feature. Therefore the insulation resistance cannot be considered as a criterion of quality in the same sense as applied to the foil paper capacitor. In voltage ratings up to and including 200 volts d-c, metallized capacitors have an insulation resistance value of 500 megohms per μ f. On higher voltage ratings the insulation resistance is 1,000 megohms per μ f.

The insulation resistance and the selfhealing voltage are to a large extent interrelated and the resultant insulation resistance is a product of these two properties. During the selfhealing cycle the surface resistance around the puncture reaches a definite value, so that with selfhealing there is a gradual reduction in the insulating resistance. The value of this resistance depends on the number of selfhealing cycles, as all of the punctured areas are in parallel.

Capacitance and Power Factor

As temperature is increased, there is a decrease of insulation resistance. This is a general phenomenon with impregnated paper, hence is not exclusive in metallized paper capacitors. Typical capacitance, power factor and insulation resistance characteristics are given in Fig. 1. Variations here are similar to those obtained with the conventional paper-impregnated capacitors. It will be noted that the mineral oil impregnated capacitors have a flatter curve than the mineral wax type and should be used in circuits demanding high capacitance stability. The mineral wax impregnated capacitor shows a definite decrease in capacitance with an increase in temperature. The decrease in capacitance with

Shooting a bird...

IN THE AIR AGE

THIS is "shooting a bird" at the U. S. Naval Air Missile Test Center, Point Mugu, California.

The "shoot" is the launching of a missile, while the "bird", in this particular case, is the Fairchild CTV-N-9a guided missile.

In a matter of seconds the missile is hurled high into the atmosphere with a deafening roar, propelled by its reaction type motors and auxiliary booster. Separation of the booster occurs as the missile speeds higher and higher into space, stabilized and controlled by the "intelligence" of its electronic guidance systems.

Soon the launching crews and ground observers no longer see the missile . . . but its path is being carefully plotted as it hurls toward its target . . . now under its own homing control.

This "shooting a bird" is but one phase of the Lark project. It is an operation requiring split-hair timing and perfect coordination. It is the result of teamwork between the Bureau of Aeronautics, Navy Department, the Naval Research Laboratory and Fairchild engineers and represents a combination of the best in aerodynamic design, electronic controls and precision manufacturing.

Here is another example of a Fairchild *first* and of "shooting a bird" . . . in the Air Age.

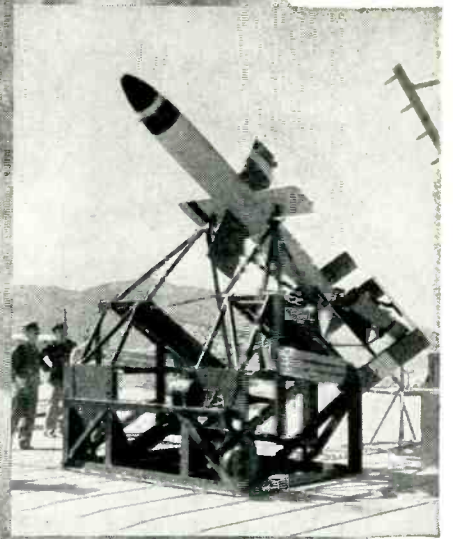
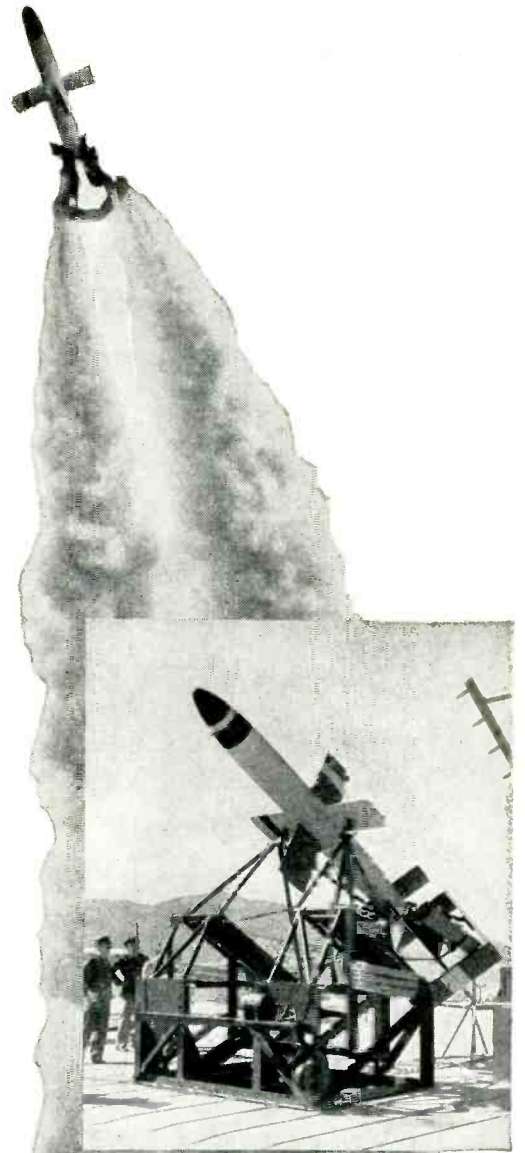

DEPT. OF DEFENSE PHOTOS

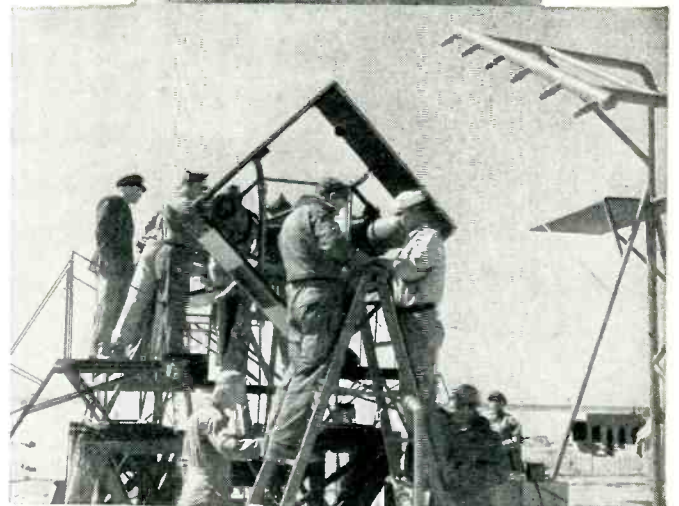
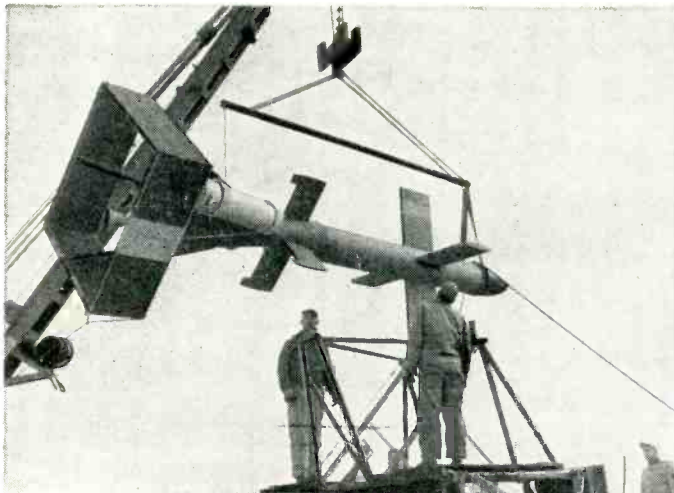

ENGINE AND AIRPLANE CORPORATION

FAIRCHILD

Guided Missiles Division

FARMINGDALE, LONG ISLAND, N. Y.

TERMINAL USED AS A NOSE!

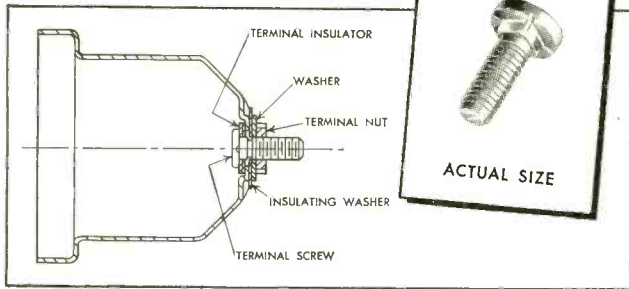

KING-SEELEY CORPORATION designed this Progressive-made terminal to permit the housing of its oil pressure unit to "breathe" — a feature that insures the presence of atmospheric conditions inside the housing and, consequently, accurate pressure registration.

Progressive was called in to make the terminal for two reasons. We have the engineering and production skills to make the part, in all its tricky detail, according to specification. And, secondly, we do a precise job at a cost that makes it worthwhile to do business with us.

We specialize in special fasteners. Use this specialization — you gain all ways.



WRITE FOR OUR CATALOG
IT MAY SAVE YOU MONEY

Other typical PROGRESSIVE "Specials"



**THE PROGRESSIVE
MANUFACTURING COMPANY**

50 NORWOOD ST., TORRINGTON, CONN.

SALES OFFICES: SAN FRANCISCO, LOS ANGELES, PORTLAND, DETROIT, PHILADELPHIA, CLEVELAND, SEATTLE, BOSTON, SYRACUSE, ST. LOUIS, CHICAGO.

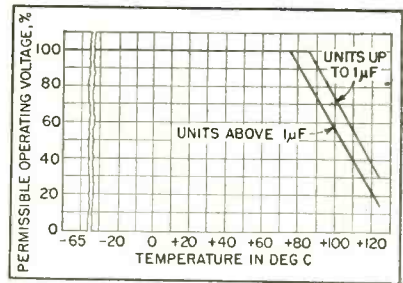

FIG. 2—Voltage derating curves for metallized capacitors operated above rated temperatures

temperature is caused by the physical change in the wax as it goes from the solid to the liquid phase; this results in a decrease of the impregnant dielectric constant.

The negative temperature coefficient of these units can be made use of in certain applications. This capacitance change is of no importance in the majority of applications. As a matter of fact, a mineral wax capacitor should be given preference because of its higher breakdown voltage except in those cases requiring a flat capacitance curve.

Operating Characteristics

Due to their selfhealing characteristics, metallized paper capacitors can be operated at higher temperatures than conventional paper-impregnated capacitors without danger of breakdown. The ultimate breakdown of the metallized paper capacitor is determined by the thickness of the lacquer coating and impregnated paper dielectric and is usually two to three times the rated working voltage.

As temperatures are increased, it becomes necessary for safe operation to reduce the voltage impressed across the capacitor. The amount of derating necessary for safe continuous operation on or above rated working temperatures is given in Fig. 2. In intermittent service the amount of derating is decreased proportionally.

Life Tests

Metallized paper capacitors should be life-tested at their permissible operating voltage and maximum operating temperature, as given in Fig. 2. A suitable resistor, preferably 1,000 ohms, should be connected in series with each test specimen in order to limit

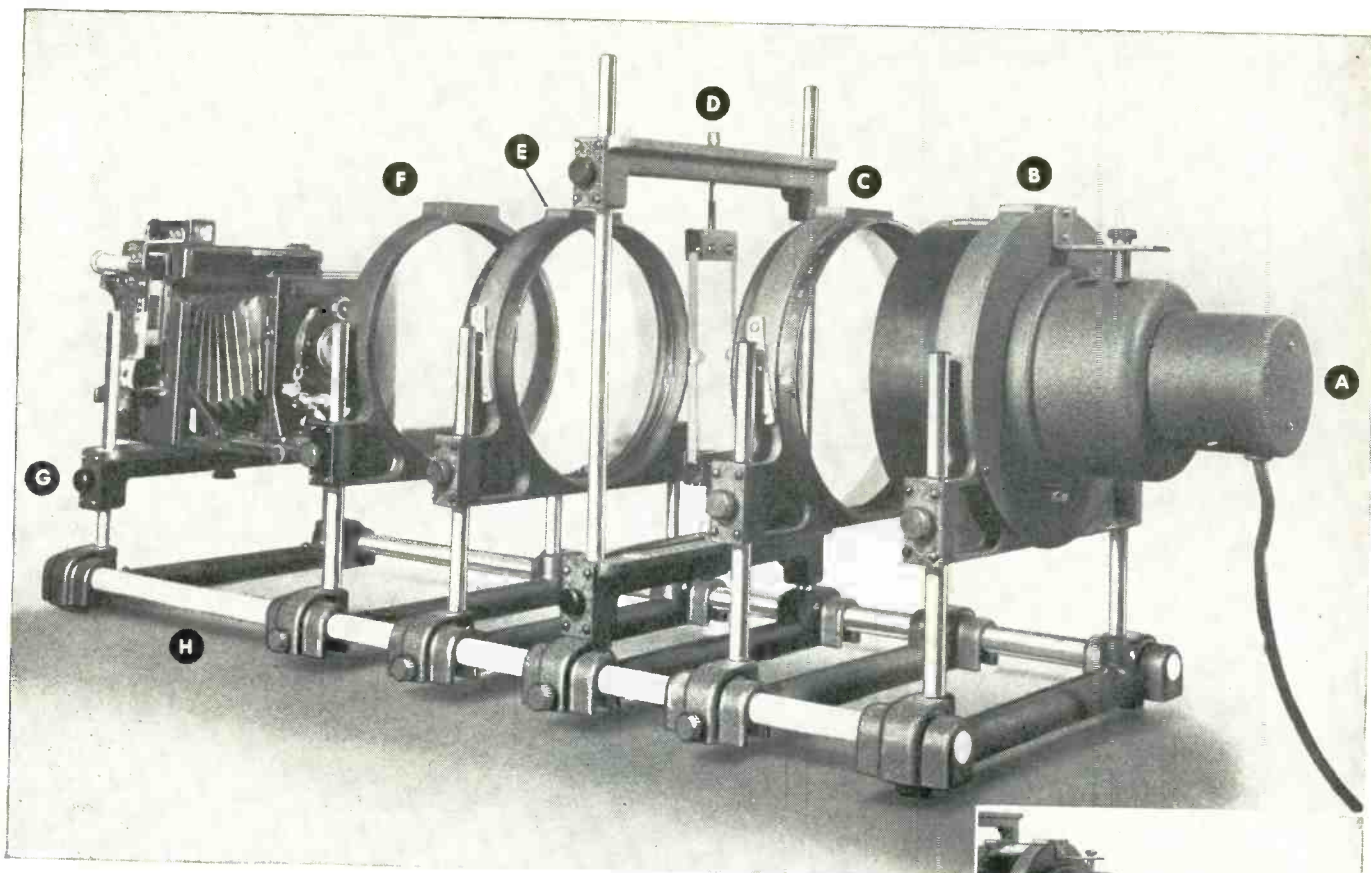

A New, Low Cost, Portable POLARISCOPE for Dynamic Stress Analysis

UNTIL now the apparatus required for either visual or photographic observation of photoelastic stress, either static or dynamic, has been cumbersome, expensive, excessively bulky and very heavy.

Through use of the G-R STROBOLUME as a very high-intensity light source for photography, all of these objections have been overcome. Formerly, photographic exposures ran into minutes; the bench set-up accordingly had to be carefully designed to minimize vibration in its many parts. The new G-R Polariscope consists of an assembly of comparatively light rods, supports and disc mounts, this lightness being possible through the extremely short 40-microsecond exposure provided by the STROBOLUME.

This new Polariscope includes in its many features:

- An unusually large field — 8 inches in diameter
- Very simple means for making instantaneous photographs of dynamic stresses . . . requires only a standard camera with an $f/4.5$ lens
- Time exposures no longer necessary . . . the STROBOLUME flashes in 40 microseconds
- The 40-microsecond flash stops motion for dynamic stress patterns
- Unusually short wave length light . . . very high sensitivity
- Complete portability . . . weighs only 32 pounds . . . quickly assembled and dissembled . . . ideal for lectures and other demonstrations
- Easily removed quarter plates and polarizers
- Simplified replacement of damaged elements . . . snap-in assembly
- Convenient to use . . . horizontal and vertical adjustments over wide ranges . . . simpler than an optical bench
- Very low cost

TYPE 1534-A POLARISCOPE . . . \$490.00



The Type 1532-A STROBOLUME in place, with its power supply at the right. One knurled nut readily removes the STROBOLUME lamp for substitution of the standard incandescent lamp for visual observation. Type 1532-A Strobolume, complete and ready to use, \$225.00

SPECIFICATIONS

- A Type 1534-P6 Incandescent Lamp Housing
- B Type 1534-P2 Diffuser
- C Type 1534-P1 Polarizer
- D Type 1534-P3 Strain Bridge for Sample
- E Type 1534-P1 Analyzer
- F Type 1534-P5 Filter
- G Type 1534-P4 Camera Bridge (Camera not supplied)
- H Type 1534-P7 Shafts (furnished 36-inches long)

Accessories Required for Photography

A G-R Type 1532-A STROBOLUME
Standard camera, preferably with ground glass focusing, with $f/4.5$ or faster lens
Wratten No. 75 front-of-lens filter, recommended to reduce effects of normal room lighting



GENERAL RADIO COMPANY

Cambridge 39,
Massachusetts

90 West St., New York 6 920 S. Michigan Ave., Chicago 5 1000 N. Seward St., Los Angeles 38

QUICK SERVICE FROM STOCK

CHICAGO

JAN-T-27 Hermetically Sealed Transformers

A Complete Range of Hermetically Sealed Units

for prototype electronic
equipment and pilot runs

- **POWER TRANSFORMERS**
FOR CAPACITOR AND
REACTOR INPUT SYSTEMS
- **BIAS TRANSFORMERS**
- **FILAMENT TRANSFORMERS**
- **FILTER REACTORS**
- **AUDIO TRANSFORMERS**
IN 3 RANGES: FULL FREQUENCY
PUBLIC ADDRESS & COMMUNICATIONS

THEY'RE AVAILABLE FOR TODAY'S IMPORTANT NEED. CHICAGO Hermetically Sealed Transformers meet all requirements of Grade I, JAN-T-27 specifications for Class A operation. Designed expressly to fill transformer requirements for military airborne, marine, and ground communication equipment, as well as for use in tropical and sub-zero climates. Ideal for a wide range of application, particularly in research and development work, prototype equipment and pilot runs. The complete range of CHICAGO JAN-T-27 units is available for quick shipment from stock.

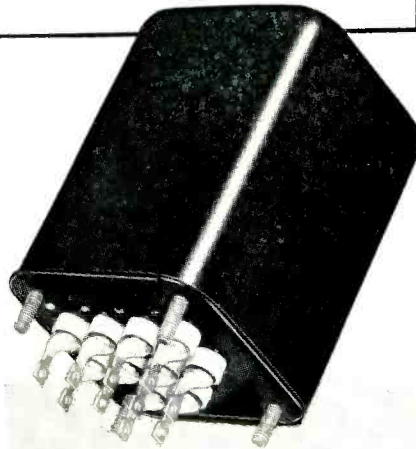

Meets JAN-T-27 Specifications

1. Alternately heated and chilled for 20 cycles (20 days) temperature range from +65°C to -10°C, 90% humidity. Also tested for 5 cycles from -55°C to +85°C.
2. Immersed in hot and cold brine at temperatures of 75°C to 0°C.
3. Subjected to severe vibration on shake table for 20 periods of 15 minutes each.
4. Given a pull test on all terminals, from all directions, of 5 lbs. or more for 30-second intervals.
5. Tested on each winding at twice rated a-c voltage and frequency.
6. Tested for insulation resistance in excess of 500 megohms throughout heat-and-cold cycles.
7. Tested for corona discharge at voltages 1 1/4 times operating voltage of transformers.
8. Capable of operation in 65°C ambient temperature with temperature rise not exceeding 40°C.
9. Operated 48 hours with 12% overload at rated ambient temperature.

**SEND
FOR IT**

NEW EQUIPMENT TRANSFORMER CATALOG

Have the full details at your finger-tips on CHICAGO'S New Equipment Line—covering all JAN-T-27 units as well as famous Sealed-in-Steel transformers engineered for every application and geared to today's circuit requirements. Write for your free copy of this important catalog today, or get it from your distributor.



CHICAGO TRANSFORMER

DIVISION OF ESSEX WIRE CORPORATION

3501 ADDISON STREET • CHICAGO 18, ILLINOIS

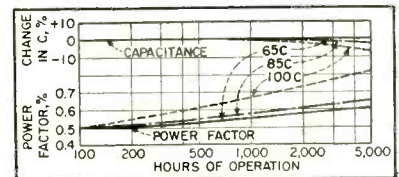

FIG. 3—Variation of capacitance and power factor with hours of operation for all d-c voltage ratings of metallized units up to and including 600 volts

the energy discharged by paralleled test specimens through a capacitor going through a selfhealing cycle. If this precaution is not taken there will be an abnormal decrease in the insulation resistance due to carbonization of the dielectric.

Metallized paper capacitors can be operated on a-c as well as d-c, can be operated at high temperatures without any serious changes in capacitance or power factor, and are practically immune to breakdown. This does not mean that their life is infinite, but rather that when metallized paper capacitors are used in a circuit there will be no early failures and the life span of the equipment will be increased. Examples of life test curves are given in Fig. 3.

Accelerated life tests can be run at 1.25 times the permissible operating voltage and maximum operating temperature, but under this test there will be a greater decrease in the insulation resistance than normally would be expected.

British Cineradiograph Apparatus

BY J. H. JUPE
Enfield, Middlesex
England

AN ADVANCED TYPE of high-voltage cineradiography apparatus has recently been put in production in Britain, by Watson and Sons, which is associated with the General Electric Co. Ltd.

The new equipment incorporates several improvements over its predecessor, which was designed to take cineradiographs by the indirect method (photography of a fluorescent screen) on 16-mm movie film. A 10-kw stationary-anode x-ray tube was used and in order to minimize the exposure of

THE NEW TURNER

Aristocrat

**MODEL 50D DYNAMIC
FOR TV - AM - FM
Recording • Broadcast
Public Address**

The crown jewel of dynamic microphones. See it, handle it — use it on highest quality recording, public address or broadcast work. New beauty, new styling, new utility and *new performance* make the Turner *Aristocrat* the finest of the fine. Use it anywhere, indoors or out — in hand, on stand, suspended, or concealed in stage settings. The *Aristocrat* is quickly and easily detached from ball swivel coupler for hand use. Non-directional polar pattern picks up sound from any direction. Equally effective for individual or group pickups with wide range, high fidelity reproduction of voice or music. Its high output dynamic generator requires no closely associated auxiliary equipment for outstanding results. Built of finest materials with flawless workmanship, each unit is laboratory calibrated to insure specification standards. . . . Write for complete details.

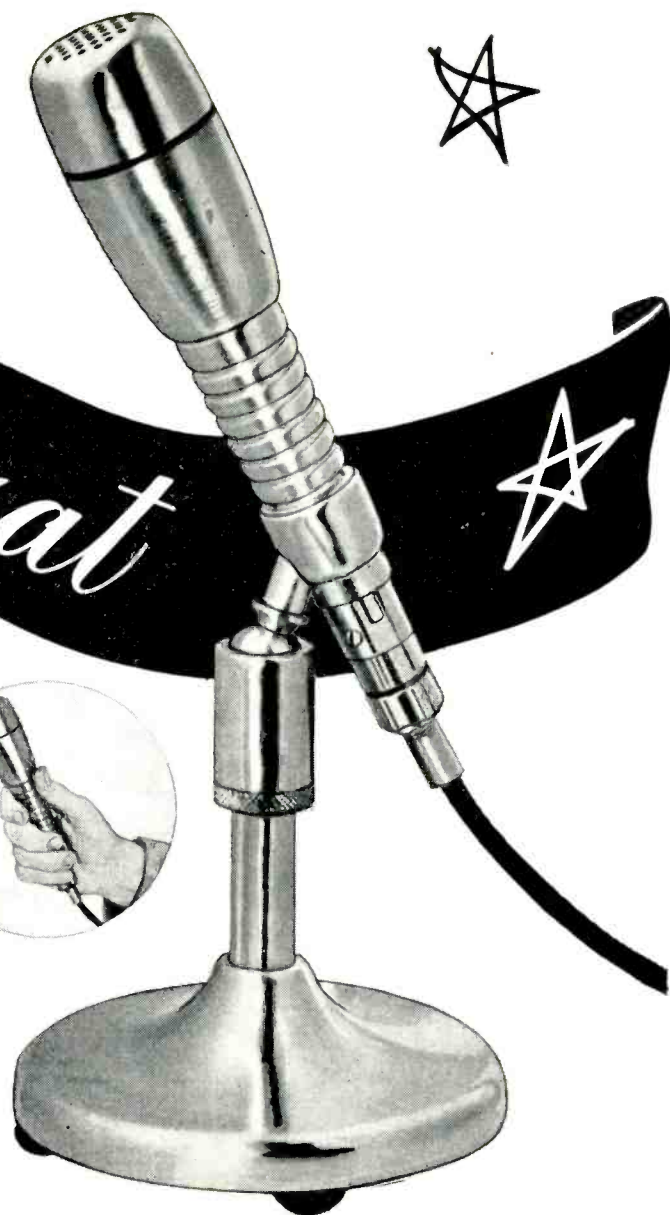

SPECIFICATIONS:

FREQUENCY RESPONSE: 50 to 15,000 c.p.s. flat within $\pm 2\frac{1}{2}$ db.
 OUTPUT LEVEL: 56 db below 1 volt/dyne/sq. cm.
 IMPEDANCE: 15, 200, 500 ohms or high impedance.
 POLAR PATTERN: Essentially non-directional in any position.
 MOUNTING: Ball and swivel type, tilts in any direction. Standard $\frac{5}{8}$ " — 27 thread.
 CABLE: 20 ft., high quality rubber covered, two conductor shielded cable with Cannon quick-disconnect plug.

THE TURNER COMPANY

905 17th Street N. E., • Cedar Rapids, Iowa
 IN CANADA: Canadian Marconi Co., Montreal, P.Q., and Branches
 EXPORT: Ad. Auriema, Inc., 89 Broad Street, New York 4, N. Y.



Microphones **BY TURNER**

P O L A R A D

TELEVISION EQUIPMENT

for studio • laboratory • manufacturer

FIELD CAMERA CHAIN

Model CV-2

OUTSTANDING FEATURES

1. Extremely sensitive at low light levels.
2. Picture resolution greater than 500 lines.
3. Four lens turret with synchronized switching.
4. Electronic View Finder.
5. Communication Channel.
6. Portable Camera Control Unit meets all requirements of programming and monitoring.
7. Portable Power Unit adjustable for all operating conditions and completely metered.

WHERE USED

Polarad's Model CV-2, Field Television Camera Chain is used both indoors and outdoors for picking up programs. Excellent picture quality and resolution are obtained even under difficult and unpredictable lighting conditions.

DESCRIPTION

Polarad's Television Camera Chain, Model CV-2, consists of:

Field Camera Unit	Camera Cable
Camera Control Unit	Lens Component:
Power Unit	50 mm, £1.9
Electronic View Finder	90 mm, £3.5
Camera Tripod	135 mm, £3.8

This ruggedly constructed camera chain is weatherized for all possible operating conditions.

Compactness and lightweight suitcase type construction of the component parts insure portability. The camera unit is supported on a special scanning mount and tripod which provides excellent maneuverability in covering a scene over a wide angle. The electronic viewfinder plugs into the camera and is detachable from it. A removable four lens turret with interlocking switches provides means for changing scenes rapidly without circuit transients.

The Camera Unit is connected to the portable Camera Control Unit by a single special camera cable. The Camera Control Unit provides the major electrical adjustments of the camera. It monitors the picture and waveform of the output signal by means of a built-in oscilloscope and picture monitors.

The Power Unit is adjustable for varying A-C line conditions and provides metering for the system. All power requirements for the Camera Chain are provided from this unit.

Polarad's Field Camera Chain, Model CV-2, is adaptable to and can operate with existing equipment.



Television Engineers and consultants to the nation's great television stations.

Polarad
Electronics Corporation

100 METROPOLITAN AVE.
BROOKLYN 11, NEW YORK



British cineradiograph apparatus. X-ray tube is in housing at patient's right. Fluorescent screen and 35-mm camera are on patient's left

the patient to x-rays, the voltage applied to the tube was reduced by means of a mechanical synchronous switching device, during periods when the camera shutter was closed.

Although this apparatus was used for much useful work, its design had some serious limitations. The patient could only be photographed in the upright position, the equipment was cumbersome and had to be operated in complete darkness. This was due to the long focal length of the lens used, a Zeiss Biotar, specially designed for the work and with an aperture of F/0.85.

With the x-ray tubes then available this aperture was the minimum which could practicably be used and because of its small acceptance angle, a long focal length (58 mm to cover 16-mm film) was unavoidable. This necessitated the camera and fluorescent screen being on separate stands to secure the correct reduction ratio and so led to operating in darkness. Other disadvantages were, poor definition and grainy films arising from the need to use a highly sensitive emulsion.

The new equipment, which was shown at the International Congress of Radiology in London recently, is a vast improvement on the early instrument and uses a rotating-anode x-ray tube energized at 120 kv, 400 ma, in conjunc-

KAY DEVELOPS - YOU BENEFIT

Your present and future needs
continuously dictate our
Engineering Policy

THE MEGA-NODE



The Mega-Node was the first commercially available random noise source.

It is extensively used for making noise figure measurements on TV receivers, radar IF strips and other receivers. It has also been used as a calibrating and effective noise bandwidth measuring equipment. Its frequency range is 5 to 220 mc, has noise outputs to 23.8 db above "Johnson" noise, and can be used either balanced or unbalanced into a variety of impedances. Its price is \$295.00

* * *

THE MICROWAVE MEGA-NODE



When the need arose for a standard random noise source in the microwave ranges we were ready with the Microwave Mega-Node. It covers frequencies from 2630 to 12,400 mc. It is built in standard JAN waveguides over this frequency range, has low VSWR and provides standard source of 15.84 db above "Johnson" noise.

Waveguide Sizes: RG48/U, 49/U, 50/U, 51/U and 52/U

Power Supply: Provides voltages for starting and operating Fluorescent Lamp Bulbs in Wave Guides

The price is \$195.00 for each wave guide and \$100.00 for each power supply. RG48/U, 49/U, and 52/U with one power supply is \$600.

THE SONA-GRAPH



The Sona-Graph is the only instrument we know that presents fourier analyses of very short time sections of audio energy.

It is now at work in many universities, research laboratories, military and industrial organizations analyzing speech, communications signals and industrial noises. It is producing non-photographic three dimensional records of intensity vs. time and frequency as well as two dimensional records of intensity vs. frequency at selected times. It analyzes signals of very short duration over the frequency range of 80 to 8000 cps with resolutions of either 45 or 300 cps. Its price is \$1795.00

Your Needs have
Dictated the Development of

THE VIBRALYZER

A NEW use of the Sona-Graph principle. It is applicable to vibration and medical studies. Tentative specifications are as follows:

Frequency Ranges: A 5 to 500 cps B 15 to 1500 cps
C 44 to 4400 cps

Filter Bandwidths: A 2 or 20 cps B 6 or 60 cps
C 20 or 200 cps

Record Time: A—20 seconds, B—6.6 seconds, C—
2.4 seconds

Displays: Number 1 INTENSITY vs. TIME and
FREQUENCY

Number 2 INTENSITY vs. FREQUENCY
at SELECTED TIMES

Note: INTENSITY may be recorded
linear in db or voltage amplitude

The price of the Vibralyzer is \$2500.00

All prices are FOB factory. Prices 10% higher outside
USA and Canada.

Send for detailed catalog covering all our equipment.

ELECTRIC

KAY

COMPANY

25 Maple Avenue

Pine Brook, N. J.

Phone CALdwell 6-4000

MILO

has all the
best lines

for industry and
research!



AEROVOX • AMPHENOL • BUD
BURGESS • CINCH-JONES
CORNELL DUBILIER
ALLEN B. DUMONT • ERIE
FEDERAL TELEPHONE & RADIO
GENERAL ELECTRIC • HAMMARLUND
HICKOK • IRC • JAMES MILLEN
KINGS ELECTRONICS
NATIONAL COMPANY
SIMPSON ELECTRIC
STANDARD TRANSFORMER
SUPERIOR ELECTRIC
SYLVANIA
ETC.

Take a gander at just a few of the latest products you want—

available now from Milo's great
warehouse of complete stocks:

CINCH-JONES*—New "300" series plugs and sockets in deep bracket mountings. New "164" barrier strips.

CONTINENTAL CARBON*—Nobelay precision resistors, ideal for meter work and other industrial applications.

ALLEN B. DUMONT LABORATORIES—New oscilloscopes, superseding the famous 208B. Type 304, \$308.00 each. Type 304H, \$328.00 each.

FEDERAL TELEPHONE & RADIO*—All types miniature and packaged power rectifiers, and RGU cables.

IRC*—New type DCH and DCF precision resistors. BTS, BTA, BT2 and BW resistors, in all tolerances and values. New CLA and CL-1 insulated chokes, readily identified with RMA color coding in microhenries.

SUPERIOR ELECTRIC*—Powerstat variable transformers and automatic voltage regulators for every requirement.

SYLVANIA*—All types of germanium crystals, new glow modulators, gas pressure tubes, TR and ATR tubes, stroboscopes, thyratrons, flash tubes.

ALLEN BRADLEY*—Potentiometers, and EB, GB, HB resistors in all tolerances and values.

*Prices and literature on these products available upon written request on your letterhead.

STREAMLINED
one-source purchasing through **MILO**

saves you money, time and effort!

Only Milo gives you ALL these exclusive buying advantages:

- ★ COMPLETE NEWEST STOCKS OF ALL THE BEST MANUFACTURERS
- ★ FACTORY PRICES
- ★ SAME-DAY SHIPMENT
- ★ LATEST TECHNICAL KNOW-HOW AND KNOW-WHAT
- ★ PERSONAL ATTENTION AND ADVICE

To get it right, to get it fast, to get it at the factory price—Call Milo's INDUSTRIAL SALES DIVISION today. Ask for Mr. Lee. Or write on your letterhead for free latest Catalog E.

MILO

PHONE

BEekman 3-2980

Radio & Electronics Corp.

200 Greenwich Street, New York 7, N. Y.

Cable Address: MILOLECTRO

The ONE source for ALL your electronic needs

tion with a specially designed 35-mm cine camera fitted with a F/1.5 Taylor-Hobson lens of 4-cm focal length.

The high voltage generator has an electronic switching device which is arranged so that the high-voltage transformer and x-ray tube are only energized during the brief period when the camera shutter is open. By adopting this plan the x-ray dose which the patient receives is reduced to a minimum and the power dissipated in the x-ray tube itself is minimized, with the result that a higher loading can be achieved without risk of tube failure.

For use at extremely slow film speeds, those for viewing slow movements of the body, the x-ray exposure can be arranged to occupy any proportion of the shutter-open period. This is done by means of subsidiary timing control in the electronic contactor circuit.

If desired, the camera, timing and synchronizing equipment can be switched out of use and radiographs can then be made on large size films by the usual still-radiography technique. In this case the synchronous timer of the equipment will determine the length of exposure.

The entire apparatus has a power consumption of about 1 kw when idling and 20 kw (average) when exposures are being made.

Single-Tube Audio Phasemeter

By JOSEPH A. VANOUS
Engineering Division
Collins Radio Company
Cedar Rapids, Iowa

A PHASEMETER is described, which is capable of measuring phase difference between two sinusoidal voltages from 300 cps to 100,000 cps. Angles from 1 to 180 degrees are measurable with an accuracy of better than 1 degree. No preliminary adjustments for frequency are necessary with this meter.

A unique property of the magnitude of the sum and differences of two alternating current voltages makes the operation of this phasemeter possible. In operation, the phasemeter is connected across the phase-shift network. After two

Modern Electronic Design Means Plug-In Unit Construction

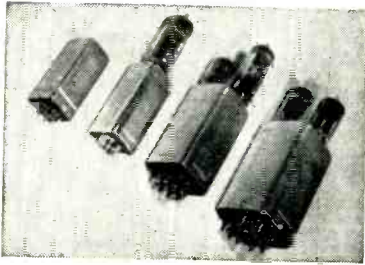

ALDEN PLUG-IN BASES AND HOUSINGS

A whole series of bases and housings to meet your plug-in needs. From the miniature 7-pin to the special 20-pin non-interchangeable, Alden plug-in bases can be standardized over a wide range of plug-in design. The Non-interchangeable Series, special for plug-in construction, is designed with variable pin patterns that insure positive isolation of critical voltages or current. Strong, stubby pins and elimination of bosses on Alden bases correct the bugaboos of conventional octal or loctal design.



Open 20 pin plug-in assembly



Shielded 20 pin plug-in assembly



Shielded 11 pin plug-in assembly



Miniature 9 pin plug-in assembly

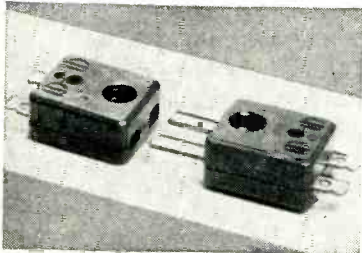

ALDEN BACK CONNECTORS

Here are back connectors that make possible slide-in chassis that go together and come apart easily. Generous bell mouthed entries and floating clip action provide wide mating tolerances — do away with critical chassis alignment problems. Wiring to color-coded back connectors instantly identifies each lead for circuit checks — makes wiring accessible for easy servicing. Can be mounted flushed or stacked to meet any space requirements.



Mechanical units

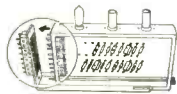

Decade units

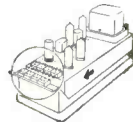

Miniature chassis

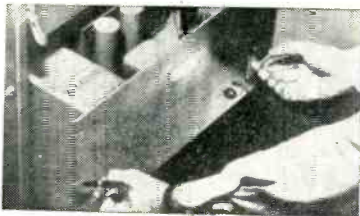

ALDEN SLIDE-IN LOCK-IN CHASSIS

Designed for quick, positive insertion and removal, slide-in lock-in chassis utilizes bullet nosed dowels which pull in, lock, and eject chassis quickly and easily. Simple 1/2 twist of handles gives positive protection against vibration shock in any position. Pilot action of locking dowels eliminates critical sheet metal tolerances. Slide-in lock-in chassis are built for racks or as separate units, miniature or standard size.

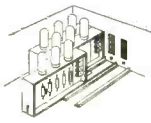

Instrumentation



Electronic



Communication

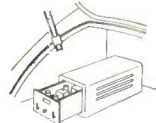

Mobile

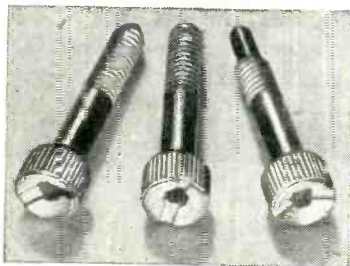

CAP-CAPTIVE CONVENIENCE SCREW

Concave surface of head and arced notch quickly center production tools on screw for rapid tightening against lockwasher. In the field, no special tools are necessary — arced slot in head is of such proportion that even a coin gives sufficient leverage to back it off lockwasher. Can readily be made captive, so it's ideal for holding detachable mechanical units, plug-in housings, miniature chassis.

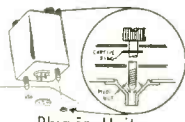

Plug-in Units

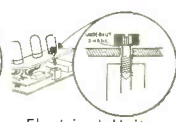

Electrical Units

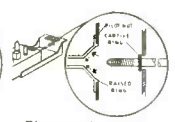

Electronic Units

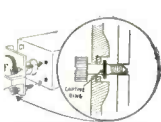

Mechanical Units

The trend in modern design is toward smaller, lighter, better looking equipment. Yet modern design demands easy servicing, rapid changeover, and foolproof performance. To get these results, more and more modern design engineers are turning to plug-in unit construction with basic elements grouped as units that plug in, slide in, lock in, and pull out easily.

Up to now there has been no one place where components specifically designed for plug-in, unit construction were available. To get this type of construction — it has been necessary for engineers — design and have parts custom made or improvise with standard components in makeshift arrangements.

For many standard applications Alden has a whole series of plug-in components that can meet many of your unitization needs. On new or special designs, we feel we have the conception and facilities necessary to take your whole problem — design, develop and manufacture plug-in components tailored to fit your needs — to give you the advantages of components specifically designed for plug-in, unit construction, advantages not found in standard components.

Write for new booklet on 'Components for Plug-in Unit Construction'

ALDEN PLUG-IN UNIT CABLING IS A MUST

For years cabling did not keep pace with the speed of electronic design — Manufacturers had to be satisfied with cables designed as an afterthought — cabling utilizing mongrel connectors and wire, designed for a job, yes, but not designed for a specific job. In the past this poorly designed cabling has led to malfunctions, time delays, excessive production costs and high service cost in the field.

With today's higher voltages, frequencies, and critical signals, more and more engineers are turning to Alden for the solution to their cabling problems because Alden's is the one place where specially designed connectors and large stocks of wire are obtainable under the same roof.

Here is what Alden engineers can do for you — take your prototype model, engineer to your specific requirements unit cables incorporating Alden's 20 years of technical design and development of connectors and wire services — give you economic and efficient cables of good appearance that are built as units — allow instant continuity checks and rapid replacement in the field.

Alden's series connectors enable the engineer to select, and know that he will get, the right connector for the job. For critical connections, Alden has special non-interchangeable connectors with plugs that can only mate with the correct socket and thereby absolutely prevent mismatching and the costly damage of burned out sets. All connectors used have forward connected, low resistance contacts which provide individual strain relief for each lead. Production design connector bodies with well-isolated clip and wire pockets provide 100% insulation. Less material — less space, features of Alden top connected contact connectors, allow Alden to design and manufacture a cable that is more compact and more easy to handle.

Wire is supplied from stock piles that include sizes and insulation of any type. It is ready to be formed, laced, braided, or shielded — in production quantities — as needed. By pooling wire requirements, a flexible high-speed braiding department, special tools, trained operators and mingling of orders, the most exacting schedules of customers can be met at production line cost.

For quotations or suggestions about design, submit your inquiries or blueprints — Alden engineers are always ready to work with you on cabling problems.

NA-ALD

Alden Products Company
117 North Main St.
Brockton 64E, Mass.

NA-ALD

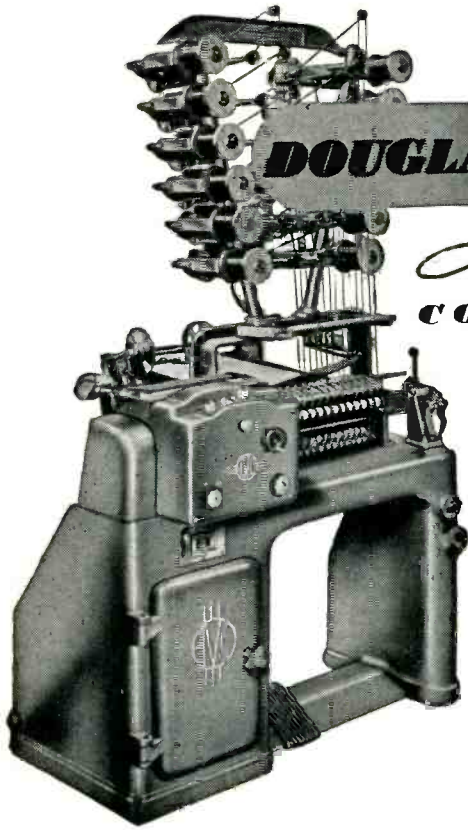

DOUGLAS AND MACADIE
Automatic
COIL WINDERS

THE large illustration depicts the improved "Douglas" Fully Automatic Multi-Winder, specially developed for the high-speed production of large quantities of coils with or without paper interleaving. It will produce round, square or rectangular coils up to 6 inches each in length and up to 4½ inches diameter. As many as twelve smaller coils can be wound simultaneously within the total available winding length of 12 inches at headstock speeds of between 600 and 2,000 revolutions per minute.

Numerous other Coil Winding and Taping Machines are illustrated in our complete Catalogue, a copy of which will be sent to interested executives on application.

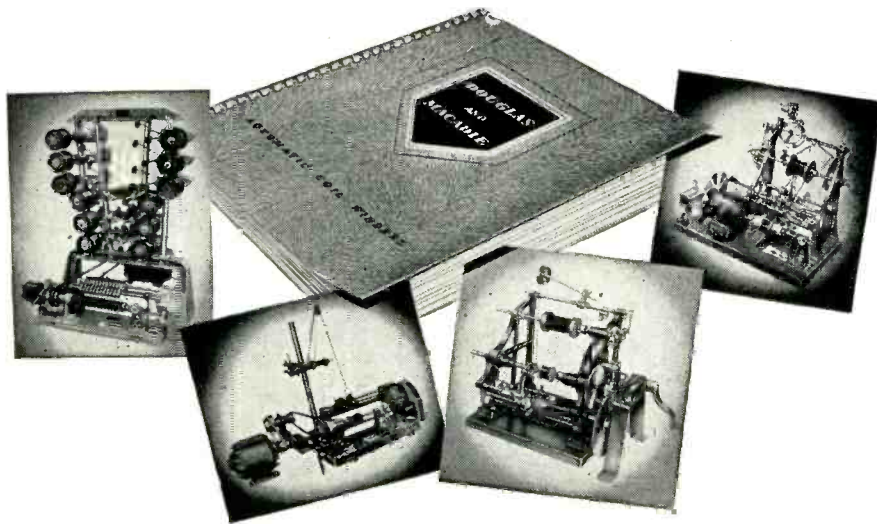

THE AUTOMATIC COIL WINDER & ELECTRICAL EQUIPMENT CO., LTD.
WINDER HOUSE • DOUGLAS STREET • LONDON • S.W.1 • ENGLAND
Cables: "Autowinda, Sowest, London."
Code: A.B.C. 5th. Edn.

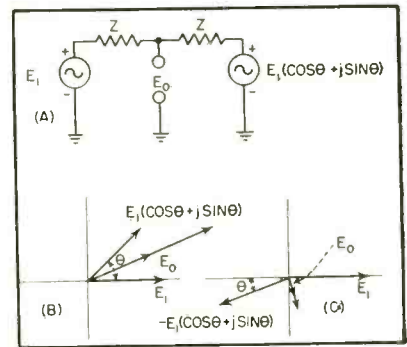

FIG. 1—Basic circuit and vector diagrams showing basis for two-tube audio-frequency phase measuring device

calibrations, the sine or cosine of half of the phase angle is measured directly. The principal value of the inverse function is found in a table of trigonometric functions. Multiplying this value by 2 will produce the phase angle in degrees.

Principle of Operation

Several other types of phase-meters employ cascaded amplifier-limiter stages which supply square waves to the indicating circuits^{1, 2}. Circuit simplicity is achieved by making a comparison between two sinusoidal waves directly.

The phasemeter consists of two low-impedance generators connected by an impedance of 2Z. The voltage at the centertap of the connecting circuit is measured by an a-c voltmeter as shown in Fig. 1A. The two voltages have the polarity shown where E₁ is the voltage at generator 1, and E₁(cos θ + j sin θ) is the voltage at generator 2. The two voltages have the same magnitude but differ by an angle θ which is the phase angle. Assuming the voltage E₀ is measured by a high-impedance voltmeter drawing negligible current, the following equation can be written

$$E_1 - E_1(\cos \theta + j \sin \theta) = i(2Z) \quad (1)$$

$$i = \frac{E_1 - E_1(\cos \theta + j \sin \theta)}{2Z}$$

$$E_0 = E_1 - iZ \quad (2)$$

Substituting Eq. 1 for i in Eq. 2

$$E_0 = E_1 - Z \left(\frac{E_1 - E_1(\cos \theta + j \sin \theta)}{2Z} \right)$$

$$= \frac{E_1}{2} (1 + \cos \theta + j \sin \theta)$$

Solving for the absolute magnitude

The *NEWEST* Development in Disc Ceramic Condensers !

RMC DISCAPS

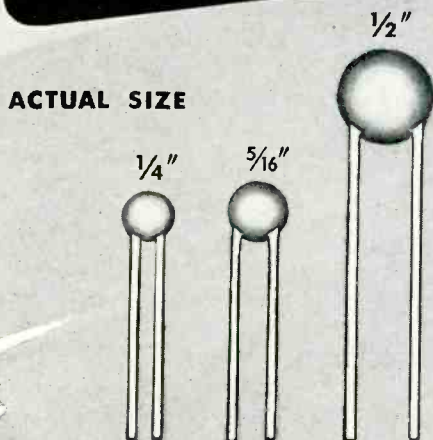

C Series
NPO and NTC
General Purpose
Low Capacity
CONDENSERS

Type	CAP. MMF. 1/4" Body Dia.	CAP. MMF. 5/16" Body Dia.	CAP. MMF. 1/2" Body Dia.
NPO		5-15	16-30
N750	5-25	26-50	51-150

Available Tolerances: $\pm 5\%$, $\pm 10\%$, $\pm 20\%$

The new C Series DISCAPS offer for the first time a disc type general purpose zero or negative temperature coefficient disc condenser ideally suited to coupling and tuned circuit applications.

C Series DISCAPS feature small size, low self inductance, higher working voltage (600 V.D.C.), low

power factor, greater mechanical strength and faster production line handling. Their low cost, plus their inherent quality characteristics make C series DISCAPS attractive to all manufacturers of high frequency equipment. Type C Series DISCAPS are available in a variety of capacities and tolerances with ratings up to 6000 W.V.

Are You Using the Now Famous Type B-GMV By-Pass Series Discaps?

Approved by leading makers of TV sets and tuners, RMC Type B-GMV DISCAPS are now available in the following capacities: .001, .0015, .002, .005, .01, 2x.001, 2x.0015, 2x.002, 2x.004, 2x.005 MFD; also Bi-element shielded section

2x.0015, 2x.005 and 2x.01 MFD. They feature small size and low self inductance and exceed GMV capacity at 85°C with 250 applied D.C.V. Capacity change between room temperature and 65°C is only + 18%, -0%.

Every DISCAP is 100% Tested for Capacity, Leakage Resistance and Breakdown

RMC production checks eliminate costly service failures. Because RMC produces the complete condenser, even to the processing of the dielectric element itself, it is possible to exercise the finest quality control. Yes, DISCAPS are definitely better!

SEND FOR SAMPLES AND TECHNICAL DATA

DISCAP
CERAMIC
CONDENSERS



RADIO MATERIALS CORPORATION

GENERAL OFFICE: 1708 Belmont Ave., Chicago 13, Ill.

FACTORIES AT CHICAGO, ILL. AND ATTICA, IND.

Two RMC Plants Devoted Exclusively to Ceramic Condensers

Maximum Wattage Dissipation for Size

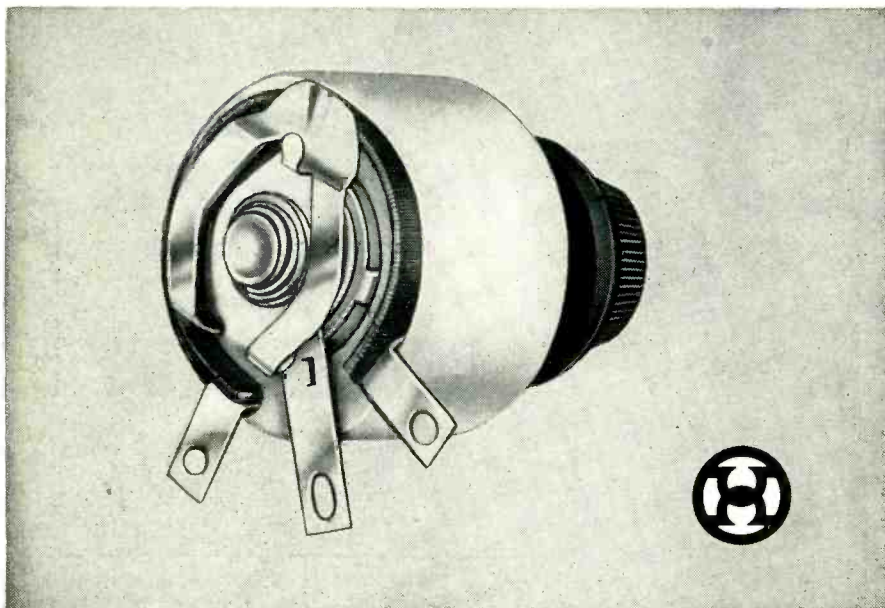

THIS COMPACT, rugged type M 25 watt rheostat offers exceptional heat dissipation. An exclusive Hardwick, Hindle feature is the lock tab which prevents deformation of the contact arm due to rough handling. Its steel stop pin will withstand over 40 inch pounds torque.

The resistance element is wound on a pure mica strip, embedded in vitreous enamel and sealed in a ceramic base—thus bonding inseparably the winding and base.

And in our type M rheostats you have a choice of 2 types of contact mechanisms, either a carbon brush or a spring metallic contact. And also a choice of 2 types of bases designed for either lug type or screw type terminals, or any combination thereof.

Other types of Hardwick, Hindle rheostats, and our many resistors offer you valuable exclusive advantages.

Write us today. Our engineers are at your service.

HARDWICK, HINDLE, INC.

Rheostats and Resistors

Subsidiary of

THE NATIONAL LOCK WASHER COMPANY

NEWARK 5, N. J.

Established 1886

U. S. A.

of the voltage measured at E_0 .

$$|E_0| = \frac{E_1}{2} \sqrt{(1 + \cos \theta)^2 + (\sin \theta)^2}$$

$$= \frac{E_1}{2} \left(2 \sqrt{\frac{1 + \cos \theta}{2}} \right)$$

$$\cosine \theta/2 = \left(\frac{1 + \cos \theta}{2} \right)^{\frac{1}{2}}$$

$$|E_0| = \frac{E_1}{2} (2) \cos \theta/2$$

$$|E_0| = E_1 \cos \theta/2$$

If the generator voltages are calibrated equal and unity in value, then the voltmeter will read the cosine of $\theta/2$. The vector diagram in Fig. 1B shows the relationship of the voltages for an arbitrary phase angle θ .

If generator 2 is reversed 180 degrees in phase the voltage E_0 will equal

$$|E_0| = E_1 \sin \theta/2$$

This can be proved by following a mathematical procedure identical to the one outlined above. The corresponding vector diagram is shown in Fig. 1C.

By calibrating the generator voltages at one volt, the voltmeter will read the cosine of $\theta/2$ or the sine of $\theta/2$ directly. A table of trigonometric functions will convert these readings to half of the phase angle. Multiplying this angle by two will produce the phase angle.

Equipment

The two low-impedance generators of Fig. 1A for measuring the the cosine of $\theta/2$ consist of cathode followers as shown in Fig. 2. Outputs of the cathode followers are connected in series by an impedance composed of two blocking capacitors and two resistors. The resist-

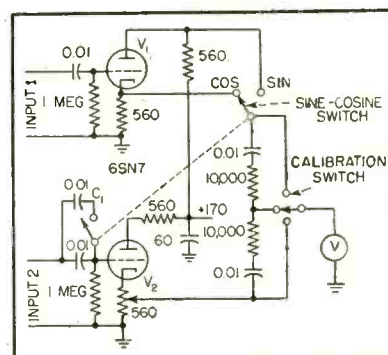

FIG. 2—Phasemeter circuit diagram shows function of sine-cosine switch

WIRE · CABLES · TUBING

OPERATING TEMPERATURES FROM -60°C TO 200° C SIZES FROM 32 TO 4/0

Surco products are manufactured in our modern well equipped plant where extra emphasis on quality control insures the finest quality products.

Our extensive, well staffed, electrical and chemical laboratories keep a constant check on production and constantly strive for new and improved designs in our wire and cable products.

SOME OF OUR SPECIALTIES

"SURCO" A-10 FOR (105°C) HOOK-UP WIRE

A-10 is an unusually high grade vinyl insulating compound developed in our own laboratories for a better hook-up wire. It has excellent resistance to deformation, soldering, high temperature, low temperature and aging; high electrical properties; Underwriters Lab. approved for continuous operation to 105°C without fibrous covering.

MINIATURE WIRE & CABLE

"Surco" miniature wire and cables are made in conductor sizes down to No. 32 AWG in stranded and solid. Close control in manufacturing permits small finished diameters on both single and multi conductor cable. Available in standard colors with and without nylon jacket or shielding in the various vinyl or polyethylene compounds.

JAN-C-76 HOOK-UP WIRE

Approval includes all types (WL—SRIR—SRHV—SRRF) in all sizes. WL available with nylon jacket or glass braid. SRIR—SRHV—SRRF available with primary insulation only or with the addition of a glass braided covering. All standard colors including "Spiralon" spiral striping.

SURFLON (200°C) HOOK-UP WIRE

"Surflon" (tetrafluoroethylene) insulation is extremely stable and capable of operation at 200°C for long periods with no appreciable decomposition. Non-inflammable. High resistance to chemicals; has no known solvent. Volume and surface resistivity very high. Surflon's electrical losses are exceptionally low, which adapts it for use on high frequency applications over a wide range of temperatures. Now available in hook-up wire sizes.

MULTI CONDUCTOR CABLES

"Surprenant" manufactures an extensive line of multi conductor cables for a variety of applications with conductor sizes from No. 32 AWG stranded and larger, with or without nylon jacket or shielding. Our "Spiralon" color coding system permits easy identification even when hundreds of conductors are involved. Our designs and close tolerances permit unusually small overall diameters.

"SURCO" TUBING

"Surco" vinyl tubing is available in special formulations for particular applications, such as, low temperature (-65°C), high temperature (105°C), U.L. approved, high dielectric strength, extreme flexibility and colors, as well as, standard compounds which are carried in stock in regular sizes. Polyethylene and nylon tubing are also available and are carried in stock in natural color, in limited sizes.

COAXIAL CABLES

"Surco" coaxial cables include a wide variety of types, such as, low capacity, extra flexibility, small diameter, microphone and 2 conductor. Many approved and conformed to Jan-C-17A. Many special designs. If you have a coaxial cable problem consult us.

"SPIRALON"

Surco "Spiralon" color coding is available on all vinyl and polyethylene insulated wire, with or without nylon jackets. One, two or three color stripes are available in the standard Nema colors. Solid color insulation is available in the 10 Nema standard colors.

NEW, IMPROVED AIRCRAFT WIRE

Nylon jacket over polyvinyl chloride for greater resistance to abrasion, fungus, moisture, hydraulic and other oils. Higher operating temperatures and better electrical properties approved under ANJC-48A. "Surprenant" manufactures aircraft wire to more rigid requirements, for newest developments contact us.

EXTRUDED NYLON STRIPS & SHAPES

Nylon flat strip for punch press operations, as well as, extruded shapes, tubes and rods are now available. Surprenant experience in the nylon extrusion field can help you solve your problems.

Our Specialty is making the unusual. We invite your problems.

Surprenant

MFG. CO.

199 Washington St., Boston 8, Mass.

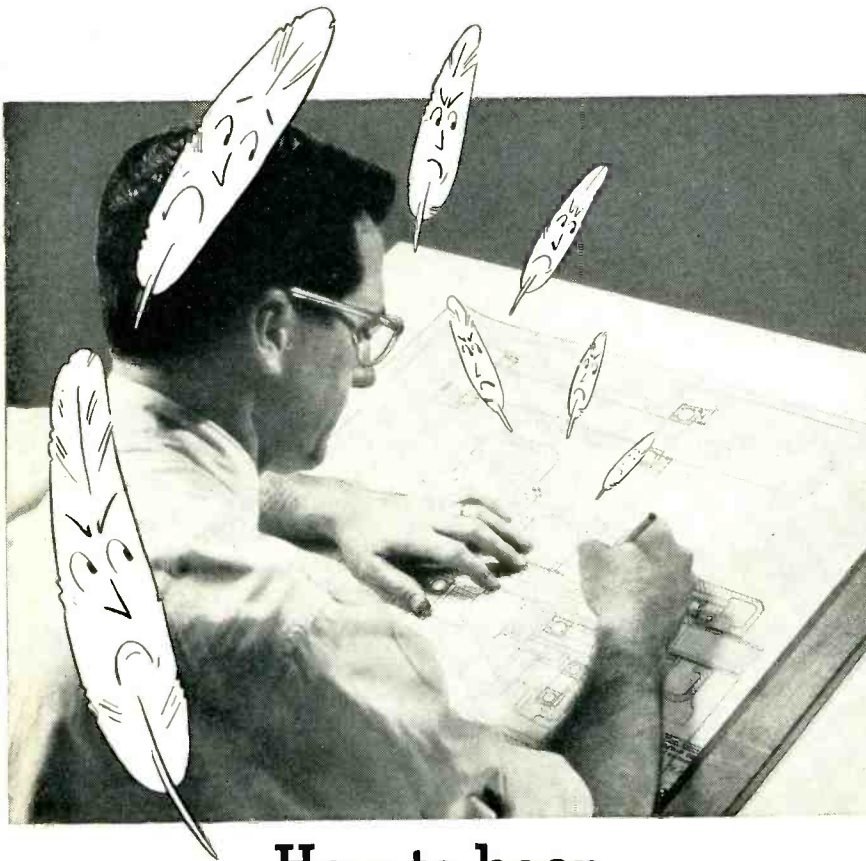

How to keep Line "FEATHERS" out of your hair !

It was a clean, sharp line till it had to be erased. But when it was re-inked, brother how it feathered and "blobbed"!

Feathering lines are one of the things you don't have to worry about with Arkwright Tracing Cloth. Even erased surfaces will take a neat, sharp line. What's more, you'll never find pinholes, thick threads or other imperfections in Arkwright cloth. You'll never have to fear that your drawings will discolor, go brittle or become opaque with age. A drawing on Arkwright Tracing Cloth will yield clean, clear blue-prints years after you make it.

Aren't your drawings worth this extra protection? Arkwright Finishing Co., Providence, R.I.

ARKWRIGHT

Tracing Cloths

AMERICA'S STANDARD FOR OVER 25 YEARS



ors are identical in value to provide a center-tap. The reactances of the blocking capacitors are also equal to produce an equal impedance both sides of center-tap. Reference to the derivation will reveal this as an initial condition.

Cathode followers were employed to provide an impedance transformation from a high input impedance to a low output impedance. It is desirable to have a high input impedance to prevent the loading of the measured network, and to prevent any additional phase shift by this loading. A low output impedance allows calibration of the voltmeter without excessive cycling.

A 180-degree phase reversal for measurement of the sine of $\theta/2$ is accomplished by obtaining the output from the plate of V_1 . The switch labeled SINE-COSINE performs this operation.

The input to each tube consists of a blocking capacitor and a grid-leak resistor. Identical components are used to prevent a phase difference at the grids in addition to that being measured while measuring the cosine of $\theta/2$. When the output of V_1 is taken from the plate for the measurement of the sine of $\theta/2$, the reactance of the filter capacitor becomes significant at the low frequencies, and creates a spurious phase shift. This unwanted phase shift is canceled by introducing an opposite phase shift at the grid of V_2 by decreasing the reactance of the R-C circuit.

The rate of change of the sine function with respect to the angle is greater for small angles. Therefore, to obtain maximum reading accuracy, the sine of $\theta/2$ is used for phase angles from 0 to 90 degrees. The cosine of $\theta/2$ position is used for angles between 90 and 180 degrees where the rate of change of the cosine function is greatest.

The phasemeter is used in conjunction with an audio oscillator as shown in Fig. 3. A 3-way calibration switch is used with the a-c voltmeter to allow the calibration of the tube outputs. The cathode resistor of V_2 is a potentiometer for adjusting the voltage to one volt. The cathode and plate output voltages of V_1 are calibrated by means of the audio oscillator attenuator control. This procedure eliminates

SAFE AT THE PLATE...



AND SO IS SELETRON!

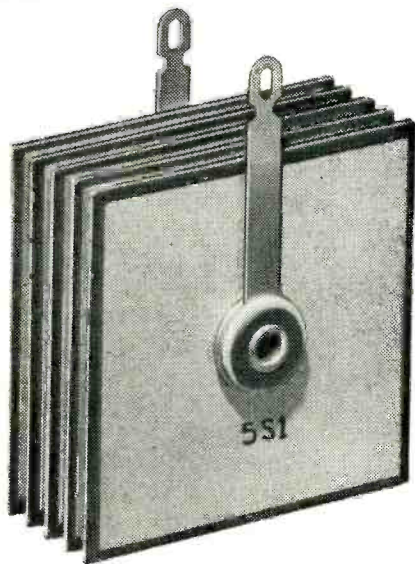

*Illustrated actual size is
No. 5S1, rated at 500
Mils DC, 130 Volts RMS
AC input.*

SELETRON "Safe Center" plates in miniature rectifiers eliminate the danger of arc-over, short circuits and excessive heating due to high leakage current at the center contact point. Assembly pressure, or pressure applied in mounting the rectifier cannot affect its performance. This SELETRON feature is accomplished by deactivating the area of the plate under the contact washer.

There are *millions* of SELETRON Selenium Rectifiers in service in radio and TV; millions more in other electronic circuits. That is why you can specify SELETRON and be *safe!* Write for your copy of our new Bulletin No. ES-32.

Seletron

SELETRON DIVISION

RADIO RECEPTOR COMPANY, Inc.



Since 1922 in Radio and Electronics



Sales Department: 251 West 19th St., New York 11, N. Y.

Factory: 84 North 9th St., Brooklyn 11, N. Y.

**YOU CAN TAKE THE HEADACHES
OUT OF LOTS OF CONTROL PROBLEMS
WITH *S.S. White* FLEXIBLE SHAFTS**

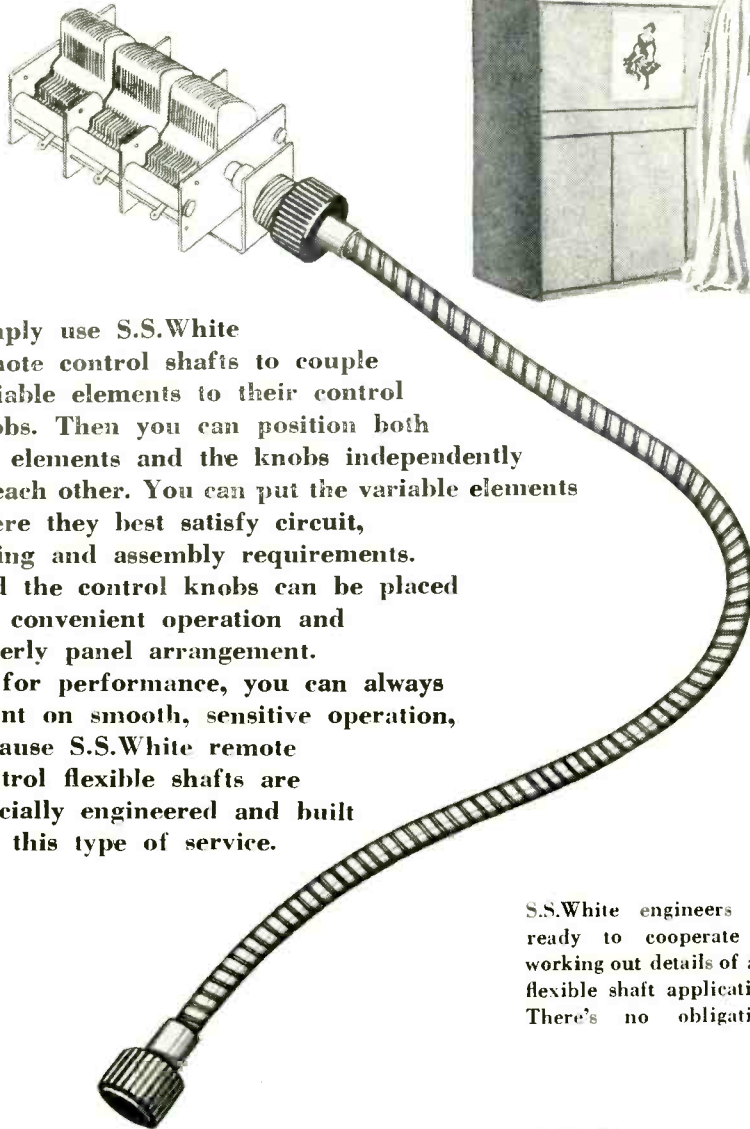

Simply use S.S. White remote control shafts to couple variable elements to their control knobs. Then you can position both the elements and the knobs independently of each other. You can put the variable elements where they best satisfy circuit, wiring and assembly requirements. And the control knobs can be placed for convenient operation and orderly panel arrangement. As for performance, you can always count on smooth, sensitive operation, because S.S. White remote control flexible shafts are specially engineered and built for this type of service.

S.S. White engineers are ready to cooperate in working out details of any flexible shaft application. There's no obligation.

WRITE FOR NEW BULLETIN 5008



It contains the latest information and data on flexible shafts and their application. Write for a copy today.



**THE *S.S. White* INDUSTRIAL DIVISION
DENTAL MFG. CO.**



Dept. E 10 East 40th St.
NEW YORK 16, N. Y.

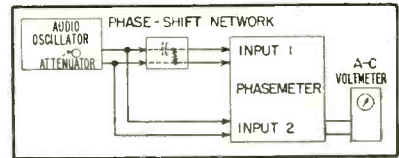

FIG. 3—In practice, the phasemeter is connected as shown here

the necessity of using potentiometers in place of the cathode and plate resistors.

Performance

The phasemeter was first tested for inherent phase shift over the frequency range. The two inputs were connected together to an audio oscillator, and readings of $\sin \theta/2$ versus frequency were taken. Under ideal conditions, the voltmeter reading will be zero, indicating zero phase shift, but a residual voltage caused by power supply ripple will normally be measured. This voltage amounted to 0.008 volts over the band, and, if considered a phase shift, equals approximately 1 degree. This is the smallest angle that can be measured.

The phasemeter was tested for accuracy by comparing measured phase shifts against calculated phase shifts of a R-C circuit. Values of capacitance and resistance obtained from an impedance bridge were used in the computations. The voltage across the resistance with reference to that across the series combination was first taken across the band. The voltage across the capacitor was then measured using the same reference. The error in the measured angles averaged 0.5 degrees.

Great differences in input voltages should be avoided. For greatest accuracy, both inputs should be approximately 1.7 volts corresponding to an output of one volt. The accuracy will then be within 1 degree from 1 to 180 degrees. If the input to V_2 is between 5 and 10 volts, then the 1-degree accuracy is maintained only from approximately 10 to 180 degrees. Excessive distortion creates harmonic voltages which predominate for small angles, and leads to an increasingly large error as the phase angle approaches 1 degree. Computation of the error due to the power supply ripple revealed it to

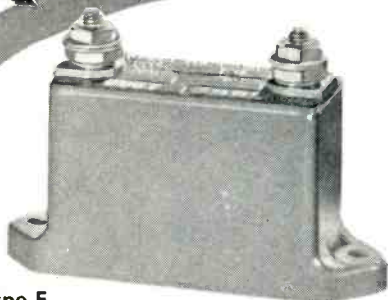

Type F
(CM65-70)



Type G (CM75-80-85-90-95)



Type H
(CM45-50)



Type A
(CM55-60)



Transmitting *Micas* for your specific needs

Built to Joint Army and Navy Specifications

Whether you need a certain characteristic, or a combination of several performance features in your specific capacitor application, you can safely specify these Sangamo Transmitting Micas for all types of military radio and electronic equipment for two reasons—first, because Sangamo Micas are service-proved by 27 years of satisfactory performance; second, they are built to meet all standards set by Joint Army and Navy Specifications JAN-C-5. They are engineered to assure high current carrying ability, to hold losses to a minimum, and to provide maximum safety.

Type G Capacitors are designed for use in

medium and high power, high voltage and high current circuits. They are ceramic encased and are frequently connected in gangs to handle heavy loads.

Type F Capacitors are used in similar applications to type G's and are potted in bakelite cases.

Type A and Type H Mica Capacitors are molded in a thermo-setting plastic and are designed for use in low voltage, low power and low current circuits.

These, and many other types of Sangamo Mica Capacitors, are fully described in Catalog No. 831. Write for your copy.

Your Assurance of



Dependable Performance

SANGAMO ELECTRIC COMPANY

SPRINGFIELD, ILLINOIS

IN CANADA: SANGAMO COMPANY LIMITED, LEASIDE, ONTARIO

How to meet a payroll (at a cost of \$3.19)



Twenty-four hours before factory payday, another check-writing machine was needed *fast*. At 10 A.M. plant manager ordered one from supplier 400 miles away. He specified Air Express, the service regularly used to keep production rolling. 26-lb. carton delivered same day at 2 P.M.—in time! Shipping cost only \$3.19!



\$3.19 was total cost — and included door-to-door service! Air Express is the most convenient way for you to ship or receive—in addition to being the world's fastest transportation method.



You get round-the-clock service with Air Express. Shipments go on all flights of the Scheduled Airlines. Air Express is service you can *count on* to keep your business rolling in high gear.

Air Express gives you all these advantages

- World's fastest transportation method.**
- Special door-to-door service** at no extra cost.
- One-carrier responsibility** all the way.
- 1150 cities** served direct by air; air-rail to 18,000 off-airline offices.
- Experienced Air Express** has handled over 25 million shipments.

Because of these advantages, regular use of Air Express pays. It's your best air shipping buy. For fastest shipping action, phone Air Express Division, Railway Express Agency. (Many low commodity rates in effect. Investigate.)

AIR EXPRESS

GETS THERE FIRST



Rates include pick-up and delivery door to door in all principal towns and cities

A service of
Railway Express Agency and the
SCHEDULED AIRLINES of the U.S.



be negligible for angles greater than 1 degree.

The writer wishes to express his appreciation to Harry L. Sandberg for his analyses and encouragement. The writer is also indebted to Clem Arnold for his suggestions and cooperation.

REFERENCES

- (1) Edwin F. Florman, Andrew Tait, An Electronic Phasemeter, *Proc. IRE*, 37, p 207, Feb. 1949.
- (2) Edward L. Ginzton, Electronic Phase-Angle Meter, *ELECTRONICS*, 15, p 60, May 1942.

NRL Microwave Interferometer

ALTHOUGH ORIGINALLY intended for measurement of wavelengths in the centimeter region, a microwave interferometer constructed at the Naval Research Laboratory on the basis of Michelson's optical instrument has also proved useful in the rapid determination of the dielectric constants of materials in sheet form. It is particularly suitable for the study of laminated radome materials, of parallel-plate media of nominal dielectric constant less than one, and of metal-loaded artificial dielectric materials for microwave lenses—media which cannot readily be placed in a waveguide as required by other techniques.

In the Michelson interferometer, a beam of light is split by a half-reflecting mirror. One part of the beam is reflected from a fixed mirror, the other from a movable mirror. When the two beams are reunited, they form interference patterns. In the microwave modification, the interference is produced between a reference signal

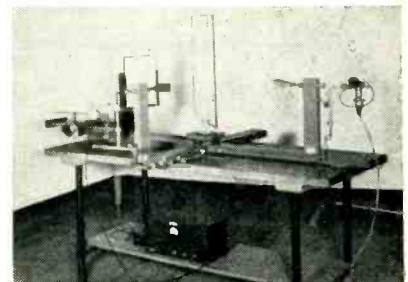

Microwave interferometer for measuring wavelengths and dielectric constants of sheet materials

Another exclusive
GPL Development

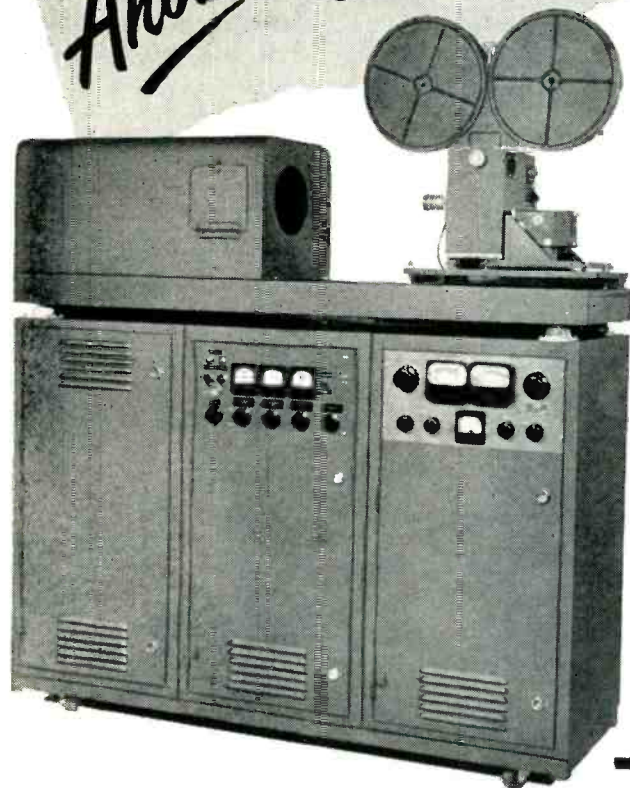

New GPL VIDEO RECORDER

WITH

Electronic Shutter

Live Show Quality - Picture and Sound - on Delayed Telecasts

**These Exclusive Features
put the
GPL Video Recorder
In a Class by Itself**

ELECTRONIC SHUTTER — Limits exposure of each film frame to 525-line scanning of tube, with accuracy better than 1% of one line. Stays in adjustment; does not require camera to be locked in synchronization with video signal.

GPL VIDEOGAM — A gray scale correction amplifier that provides better video pictures than normally possible. In addition, a special deflection yoke provides perfect focus across entire screen.

GPL FILM GATE — Permits over 30 minutes of continuous camera operation without film abrasion, emulsion pile-up and consequent difficulties.

HIGH FIDELITY SOUND is recorded simultaneously. Essentially flat recording to 7 kilocycles, with low harmonic and intermodulation distortion, gives results comparable to finest 35-mm sound.

This new 16-mm Video Recorder makes possible, for the first time, delayed telecasts that are consistently as good as the original. GPL's exclusive new shutter — electronic instead of mechanical — is coupled with improvements in picture resolution, film gate design, and sound fidelity. The projected recording is markedly better than the picture obtainable on most receivers. Re-telecast with good equipment, the picture looks and sounds like a live show.

The GPL Video Recorder may be used with the GPL rapid processor to produce finished film, positive or negative, less than a minute after the program is received either over a closed circuit or from the air.

WRITE FOR RECORDINGS made on this equipment for study by studios, advertisers, agencies.

TV Camera Chains • TV Film Chains
TV Field and Studio Equipment
Theatre TV Equipment



General Precision Laboratory

INCORPORATED

PLEASANTVILLE

NEW YORK

you
benefit
by

THE CENTURY OF EXPERIENCE
BEHIND B&J FASTENINGS



**BLAKE &
JOHNSON**
Fastenings

Slotted or Phillips head machine screws, wood screws, stove bolts, tapping screws, special headed products; nuts, rivets, chaplets, wire forms, screw machine products . . . in steel, stainless steel, copper, brass, bronze, everdur, nickel, nickel silver, monel, aluminum . . .

WRITE FOR catalog of complete line of Blake & Johnson fastenings. Address Dept E-8.

THE BLAKE & JOHNSON COMPANY, WATERVILLE 48, CONN.

led through a waveguide and a signal reflected from a movable metal reflector and a fixed half-reflecting mirror. In this way, phase and amplitude of an essentially plane wave may be compared with that of a reference signal.

The instrument was developed by Radio Division One of the Naval Research Laboratory.

Ultrasonics Used In Seed Treatment

A DETAILED STUDY of the effects of high frequency sound radiation on hybrid corn is in progress at the U. S. Department of Agriculture Research Center at Beltsville, Maryland.

Using a high-intensity ultrasonic generator, government agronomists are trying to evaluate the effects of time and intensity of treatment on germination, flowering, growth and yield. Seeds exposed to the high intensity radiation have been planted recently in field test plots. The agronomists have their fingers crossed.

Based on previous experiments with other seeds they expect a faster germination, but also possible failure of some of the seeds to take root. The end object of the research, of course, is higher production.

The piezoelectric generator operates on four fixed frequencies. It is essentially a radio-frequency generator modified to match the electrical impedance of a transducer through a coaxial cable. The complete equipment is housed in a battery jar containing about 12 liters of transformer oil.

To get a constant indication of the radio-frequency volt-amperes in the high-frequency line to the transducer, a radio-frequency ammeter and a vacuum-tube voltmeter have been added.

On the top of the battery jar is a copper shield, which has in the center a copper cup of about 3 inches in diameter and 3 inches deep. A 2-inch hole in the bottom of the cup is covered by a strip of copper less than 0.002 inch thick. The cup acts as a container for a

Potter INSTRUMENT COMPANY

INCREASED MANUFACTURING & DEVELOPMENT FACILITIES

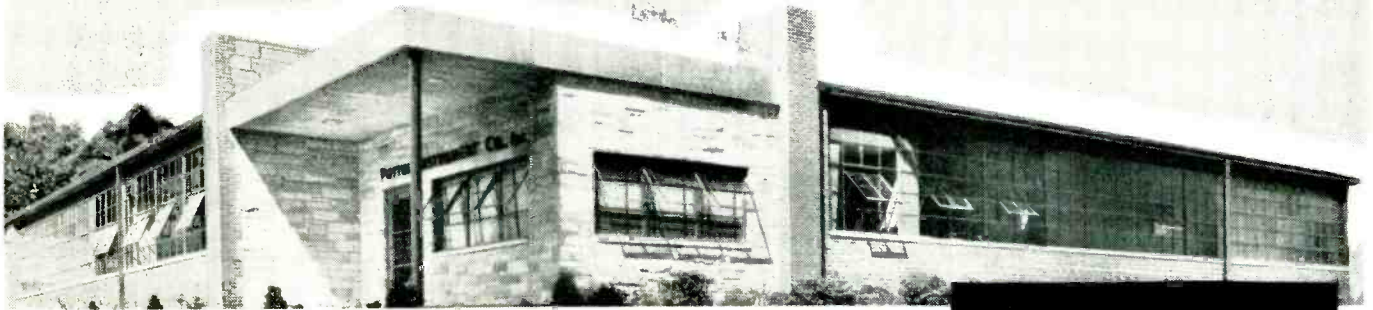

YOU, OUR CUSTOMERS, have been presenting us with problems which require skill not only in electronic circuitry but in unique mechanical design as well.

In solving many of your problems, we have found it necessary to think in terms of the most compatible combination of electronics and mechanics. Many companies are expert in one or the other of these fields, but a company which is skilled in both is rather rare. Realizing this fact, we have made a greater effort to mold our organization and facilities accordingly. Our latest step in this direction has been to construct a new plant with complete machine shop facilities and increased manufacturing space. Another goal for which we have been striving is circuit simplification. Our philosophy for the last eight years has been to design equipment with the fewest number of tubes and components without compromising on dependability. The result of this philosophy is evident in the basic 4-lamp Potter Decade and in new equipment designs yet to be announced. These include simplified and economic arithmetic units, multi-purpose shift registers, storage devices, photoelectric readers, tape handlers and a radically new high speed line-at-a-time printer.

If you are concerned with problems in these fields, write to Dept. 6-S for additional information.

- High Speed Electronic Counters and Scalers
- Precision Chronograph and Timing Instruments
- Frequency Measurement Counters
- Electronic Digital Computers and Memory Devices
- High Speed Printer Units and Data Handling Equipment



POTTER INSTRUMENT COMPANY

INCORPORATED

115 CUTTER MILL ROAD, GREAT NECK, NEW YORK



PREDETERMINED COUNTERS feature counting rates to 60,000 per minute, absolute accuracy, instantaneous automatic reset, simple dial selection of count.



DECADE COUNTER provides direct decimal read-out with the simplest most reliable decade circuit mode. Finest components, superb construction.

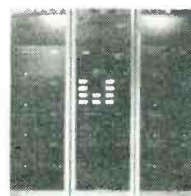

TIME STUDY COMPUTER—custom designed to compute operation waiting time for payroll applications, etc.; also computes most efficient combination of man and machines.



1.6 MC COUNTER CHRONOGRAPH with high resolution and accuracy (1/1,600,000 second). Indicates intervals up to 1 second. Dependable, stable, no adjustments required.

Timing Ideas

**DO
SOMETHING!**



That's what this versatile interval timer by Haydon® says when its buzzer sounds off. This audible signal — at cycle completion — sounds continuously until manually turned off. The unit is driven by a dependable Haydon synchronous motor; is built to give constant, efficient service over thousands of cycles.

FEATURES? LOTS OF THEM!

1. Many intervals available with a wide range of motor speeds and minor variations in design.
2. Optional buzzer for audible signal at completion of cycle; sounds continuously until manually turned off.
3. Load contact ratings: 10A, 250 VAC; 1/2 HP, 250 VAC.
4. Unusually compact design; 3-53/64" x 2-55/64" x 1-25/32".
5. Snap action device for quick break.
6. Operates at peak efficiency in any mounting position.
7. Designed for use in tight spaces.

ALL HAYDON TIMERS GIVE YOU

these features of the dependable Haydon motor
Total enclosure — Very small size — Slow (450 rpm)
rotor for long life, quiet operation—Controlled
lubrication with separate systems for rotor
and gear train — Mounting and operation
in any position.

® TRADE MARK REG. U. S. PAT. OFF.

For complete design and engineering specifications, write for catalog: Timing Motors No. 322 — Timers No. 323 — Clock Movements No. 324. Yours without obligation.

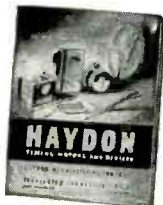

HAYDON
AT TORRINGTON

HEADQUARTERS FOR
TIMING

HAYDON Manufacturing Co., Inc.
2434 ELM STREET

TORRINGTON, CONNECTICUT
SUBSIDIARY OF GENERAL TIME CORPORATION

cooling bath. Water is used in the cup as a practical liquid for both immersion and cooling of test specimen. The radiations originating at the crystal are transmitted through the oil into the test cup.

Although there are in existence about a half dozen material-testing devices that use ultrasonics, experiments in agriculture and more properly biology, have not begun until recently.

USDA's research is supervised by Truman E. Hinton, head of farm electrification studies in the Agricultural Research Administration.

Direct-Reading R-F Wattmeter

EASE OF OPERATION and excellent accuracy are combined in a direct-reading r-f wattmeter developed by the Naval Research Laboratory for measuring power from 30 to 3,000 microwatts. Instead of the a-c substitution method employed by many types of wattmeters for measurement of r-f power, the new type makes use of a d-c movement meter and precision resistors (thermistors) to achieve an accuracy of 4 percent or better over its power-measurement range.

A thermistor is placed in one arm of a bridge circuit whose other arms are usually 200 ohms each. A given amount of d-c current is passed through the bridge and an adjustable a-c voltage is connected and varied until the bridge is balanced. When r-f power is applied to the thermistor, the d-c current is automatically reduced until the bridge is again balanced. Thus with the bridge balanced, the change in d-c power in the thermistor is equal to the r-f power. A meter circuit is arranged to read this change directly.

Although this instrument was first intended for use in power monitoring work, other uses for it have arisen, such as that of checking signal generator output. The instrument was developed in Radio Division Two of the Naval Research Laboratory.

Before Any Other Consideration

Integrity of Circulation

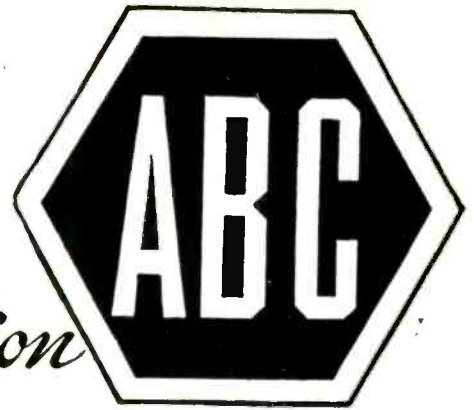

OF THE several factors that enter into the use of published media, the distribution of the advertisers' sales messages, as governed by the selection of media, can of itself decide the success or failure of the advertising investment. That is why integrity of circulation is the first consideration with experienced space buyers.

The emblem shown above stands for the FACTS that make it possible for advertisers to select the right media and to know what they get for their money when they invest in publication advertising. It is the emblem of membership in the Audit Bureau of Circulations, a cooperative and nonprofit association of 3300 advertisers, agencies and publishers.

Working together, these buyers and sellers of advertising have established standards for circulation

values and a definition for paid circulation, just as there are standards of weight and measure for purchasing agents to use in selecting merchandise and equipment. In other words, A.B.C. is a bureau of standards for the advertising and publishing industry.

A.B.C. maintains a staff of specially trained auditors who make annual audits of the circulations of the publisher members. Information thus obtained is issued in A.B.C. reports for use in buying and selling space. All advertising in printed media should be bought on the basis of facts in these reports.

This business paper is a member of the Audit Bureau of Circulations because we want our advertisers to know what they get for their money when they advertise in these pages. Our A.B.C. report gives the facts. Ask for a copy and then study it.

SOME OF THE AUDITED INFORMATION IN A.B.C. BUSINESS PAPER REPORTS

SEND THE RIGHT MESSAGE TO THE RIGHT PEOPLE

Paid subscriptions and renewals, as defined by A.B.C. standards, indicate a reader audience that has responded to a publication's editorial appeal. With the interests of readers thus identified, it becomes possible to reach specialized groups effectively with specialized advertising appeals.

- How much paid circulation.
- How much unpaid circulation.
- Prices paid by subscribers.
- How the circulation was obtained.
- Whether or not premiums were used as circulation inducements.
- Where the circulation goes.
- A breakdown of subscribers by occupation or business.
- How many subscribers renewed.
- How many are in arrears.



M c G R A W - H I L L P U B L I C A T I O N S

A.B.C. REPORTS — FACTS AS THE BASIC MEASURE OF ADVERTISING VALUE

PHALO

Offers ASSURED QUALITY



All PHALO plastic insulated wire and cables, cord sets and other assemblies have one characteristic in common . . . they are all *quality assured!* The latest in testing equipment and methods guarantee this to every PHALO customer.

Your inquiry will have our prompt attention!

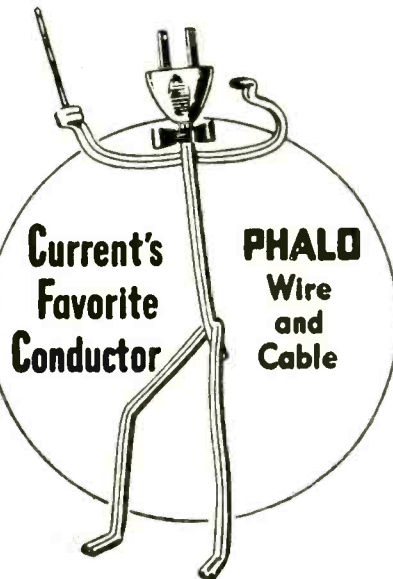

Ask for the latest PHALO catalog.



PHALO
Plastics Corporation

CORNER OF COMMERCIAL AND
FOSTER STREETS, WORCESTER, MASS.

Manufacturers of Thermoplastic insulated wire, cables, cord sets and tubing.

NEW PRODUCTS (continued from p 126)

school lab projects and for safety checks in radiation labs. The circuit features a G-M tube, built-in amplifier with CK522 AX subminiature tube, and regulated vibrator-type high-voltage power supply. Weight is 2½ pounds.



Tiny Gamma Detector

THE KELLEY-KOETT MFG. Co., 117 E. Sixth St., Covington, Ky. Model K-550 pocket-sized unit for the detection and measurement of gamma radiation measures 4½ in. × 2½ in. × 1½ in. The detecting element is a subminiature type 300-volt Geiger tube. Normal background response to cosmic radiation is approximately 12 counts per minute. Thus, increases in gamma radiation levels up to 8 or 10 times background are readily detectable by counting the pulses heard in the hearing-aid type receiver furnished with the instrument.



P-A Amplifier

RAULAND-BORG CORP., 3523 Addison St., Chicago 18, Ill. Model 1932 Green-Gem p-a amplifier is rated 32 watts at 5 percent or less har-

for **PROVEN RESULTS** specify

McGRAW-HILL

Mailing Lists

**You can save time, avoid needless expense, increase your results
by having McGraw-Hill Lists do your mail advertising job!**

Three quarters of a century of practical experience is made available to you when you turn your direct mail jobs over to McGraw-Hill. And these seventy-five years of leadership in the development and perfection of lists assure you the maximum results at the lowest cost per order or inquiry.

Those who are acquainted with mailing lists know that year-after-year acceptance of lists does not come by chance or luck. Accepted lists, like McGraw-Hill's, hold their places by merit alone. Nor does success one day guarantee success the next. Vigilant eyes must constantly add new names, delete, change, check, recheck, etc. Inferior lists are dropped as soon as shortcomings are noticed . . . "good lists" yield to better lists.

For seventy-five years expert list users have preferred McGraw-Hill by long odds. No matter how few names you use—whether your business is large or small—the best lists, McGraw-Hill Lists, are the most economical in the long run.

The world-wide reputation McGraw-Hill has earned as builders of the finest mailing lists was born of constant research in our office and in the field—constantly adding new names . . . developing new markets, new avenues of revenue for direct mail list users.

McGraw-Hill Mailing Lists are built—and constantly maintained—to provide, as accurately as humanly possible, complete rosters of the industries we serve.

Investigate their tremendous possibilities in relation to your own product or service. Your specifications are our guide in recommending the particular McGraw-Hill lists that best cover your market. When planning your industrial advertising and sales promotional activities, ask for more facts or, better still, write today. No obligation, of course.

*Proven
Results*



McGRAW-HILL
DIRECT MAIL LIST SERVICE

McGraw-Hill Publishing Co., Inc.

DIRECT MAIL DIVISION

330 W. 42nd Street, New York 18, N. Y.

Direct Mail Division, McGraw-Hill Publishing Co.
330 West 42nd Street, New York 18, N. Y.

Please send me, at no cost, mailing list information that will cover my markets.

Name Title.....

Company

Address

City and State.....

Product or Service.....

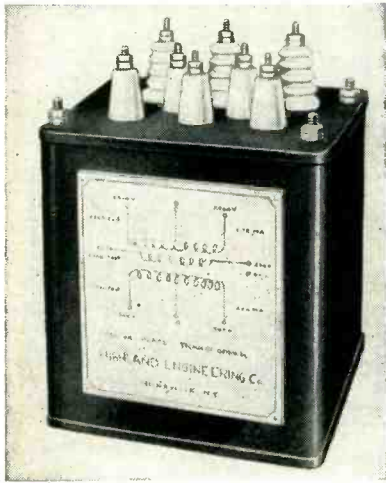

HIGHLAND TRANSFORMERS

Industrial Control
Discriminators
Electronics
Rectifiers
Welding
Filters

Hermetically Sealed Units
Open or Closed Type
Class H Insulation
5VA—50 KVA

Send us your prints or specifications for our prompt attention. All units built to your requirements on short notice at competitive prices.

HIGHLAND ENGINEERING CO.

32 HOLMAN BLVD., HICKSVILLE, N. Y.
Telephone: Hicksville 3-2727



NATIONAL

- Proven
- Dependable
- Quality

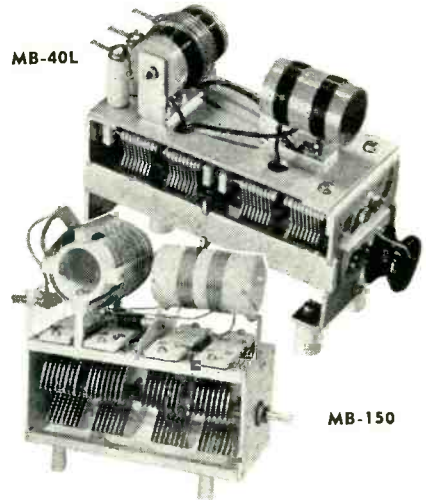

MULTI-BAND TANK ASSEMBLIES

The unique MB-150 high-power and MB-40L low-power multi-band tank assemblies will tune all bands from 80 to 10 meters with a single 180° rotation of the capacitor without changing coils.

The MB-150 is intended for use in plate tank circuits having an input up to 150 watts. It is ideal for a pair of 807's, 809's or a single 829 B. Net \$18.75.

The MB-40L may be used in the grid circuits of tubes employing the MB-150L in the plate circuit. Will handle 40 watts if link is kept loaded. Net \$9.90.

Address export inquiries to
Export Div., Dept. E-1050



PYROFERRIC COMPANY

pioneers in the technique of powder metallurgy and manufacture of iron cores for the electronic and radio industry

announces a NEW department

DEVOTED TO POWDER METALLURGY AND IRON CORE
DEVELOPMENT AND MANUFACTURE

for the UNITED NATIONS Armed Services Requirements

A group of experienced engineers and specialists in powder metallurgy and iron core development and manufacture have been assigned to this new department . . . they are available for consultation on matters connected with the requirements of our armed services . . . there are no limits to the number of items to be produced . . . no requirements too small or too large.

Consult PYROFERRIC on your iron core or powder metallurgy problems!



PYROFERRIC Co.
621 EAST 216 ST., NEW YORK 67, N. Y.

monic distortion (measured at 100, 400 and 5,000 cycles); with a 48-watt peak output. It features 3 microphone inputs (each convertible for use with a low-impedance mike by means of a plug-in transformer); 2 phono inputs with dual fader; true electronic mixing and fading on all 5 inputs; separate bass and treble tone controls. Frequency response is ± 1 db, 40 to 20,000 cps. Output impedances are 4, 8, 16, 166 (70 volts), 250, 500 ohms.

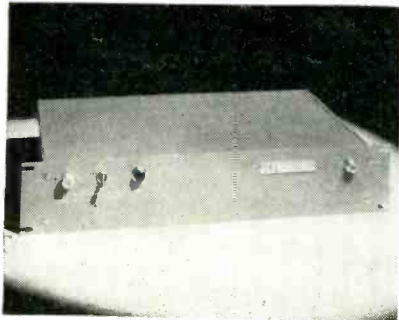

TV Amplifier

SPENCER-KENNEDY LABORATORIES, INC., 186 Massachusetts Ave., Cambridge 39, Mass. Model 212TV amplifier, specifically designed for television use, is a single untuned amplifier having a bandwidth of 40 to 240 mc and a gain of 20 db into a 72-ohm unbalanced load and 25 db into a 300-ohm balanced line. Transmission characteristic is ± 2 db over the bandwidth and impedance is 200 ohms.

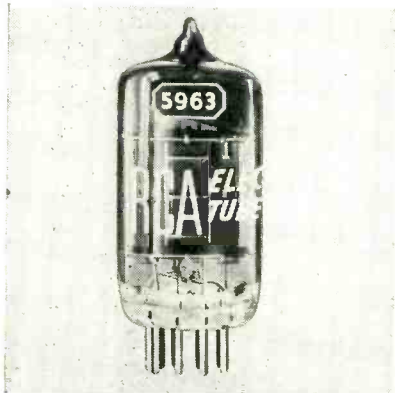

Nine-Pin Miniature

RADIO CORP. OF AMERICA, Harrison, N. J. The 5963 medium-mu twin triode of the 9-pin miniature type

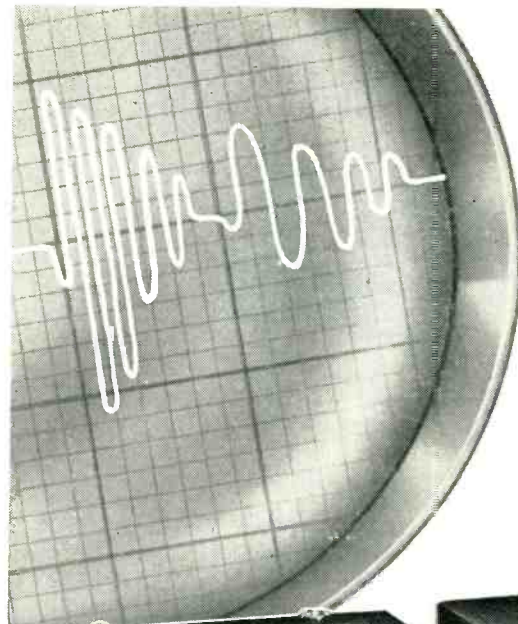

**“Sound”
Research**

Develops a
**BETTER
PRODUCT!**

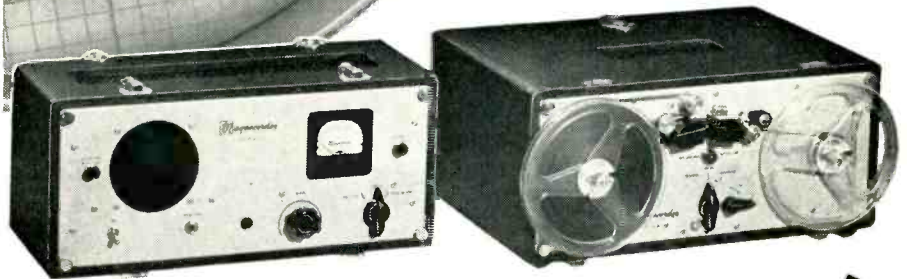

with **Magnecord**
Tape Recordings

Research departments have found a better way to take notes on electronic data and noise... They record the actual sounds on magnetic tape using Magnecord tape recorders exclusively.

Magnecorders are sturdy and give perfect reproduction under the most difficult conditions. Light-weight — one man can carry a Magnecorder anywhere!

Moderately priced for every industrial application. Find out how “Sound” Research can help improve your product.

HIGH FIDELITY • 50 to 15 KC

No other recorder offers such a wide frequency range at such a low price. Special models to fit your special needs for

- NOISE ANALYSIS VIBRATION TESTS
- SOUND IMPULSES TELEMETERING

Write for complete specifications

Send me further information on Magnecorder tape recordings for industrial uses.

Name

Company

Address

City..... Zone..... State



SEND THIS COUPON TODAY!

Dept. E 10 360 N. MICHIGAN AVE. • CHICAGO 1, ILL.

SPECIAL APPLICATIONS

GANGED LINEAR AND NON-LINEAR POTENTIOMETERS



This three-gang precision potentiometer assembly is just one more example of Fairchild's answer to customers' special-application problems.

The assembly combines on a common shaft, two 736 non-linear potentiometers, specially wound to an empirical function, with a highly accurate ($\pm .15\%$) 747 linear unit. Ganging in this manner saves considerable space and virtually eliminates error accumulation such as would occur if each unit were operated on its own shaft.

Fairchild's Potentiometer Sample Laboratory engineers can help you in analyzing your special applications. Write complete details on your requirements to Dept. 140-11A1, 88-06 Van Wyck Boulevard, Jamaica 1, N. Y.



when you need resistors—

IT WILL PAY YOU TO
CONSULT THE NEW

IN-RES-CO CATALOG

Included are complete descriptions and specifications on wire wound resistors of all types and sizes. Each is precision wound to close tolerance, and many feature special moisture-proofing to assure proper functioning under severest climatic conditions. INRESCO Resistors—available for IMMEDIATE DELIVERY—are supplied in standard or custom types to meet the most unusual design or operational requirements, and are offered at prices that benefit from mass production facilities. A copy of the new INRESCO catalog will be helpful; write for it today. Prices, samples and estimates promptly on other than standard resistors.



INSTRUMENT RESISTORS COMPANY

1036 COMMERCE AVE., UNION, N. J.

Wire Wound
Resistors for Every Use
in Electronics and
Instrumentation



FLAT WASHERS LOCK WASHERS TO MEET ARMED FORCES SPECIFICATIONS

HERE THEY ARE — QUICK DELIVERIES!

You can fill your contract needs in flat and lock washers at Garretts. We manufacture a complete line of high quality washers made to meet the most exacting specifications of the Army, Navy and Air Force. These product-proved washers include:

AN 935	AN 960
AN 940	AN 961
AN 945	AN 970
AN 950	AN 975
AN 955	NAS 143

NAS 143C

Ordnance BEBX1
Ordnance BEBX2
Ordnance BEBX3
Ordnance BECX3
and many others

For high quality and quick deliveries on the above washers, send your order to Garretts. We can supply them in regular steel, spring steel, stainless steel, brass, bronze, monel metal, aluminum, Alclad and copper as specified. We plate them with zinc, cadmium, nickel, brass, chrome . . . or they can be parkerized.

Garrett, as a manufacturer, offers you one source and quick deliveries on all types of small parts—flat washers, spring lock washers, stampings, springs, hose clamps, snap and retainer rings. Write for new folder of specifications for Armed Forces washers.

Manufactured by
GEORGE K. GARRETT CO., Inc.
Philadelphia 34, Pa.

GARRETT

OF
PHILADELPHIA

is especially designed for frequency-divider circuits in electronic computers, and other on-off control applications requiring long periods of operation under cutoff conditions. A bulletin giving complete technical data is available.



Rectangular TV Tube

GENERAL ELECTRIC Co., Syracuse, N. Y., is now producing the 17BP-4A, a 17-inch magnetic-focus-and-deflection tube with a neutral-density faceplate. It features an electron gun designed to be used with an external, single-field ion-trap magnet for the prevention of ion-spot blemish. An external conductive coating serves as a filter capacitor when grounded. Heater voltage is 6.3 v and heater current is 0.6 ampere ± 10 percent.

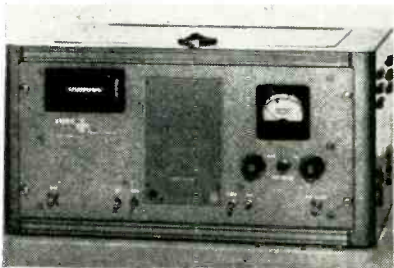

Scaler

ATOMIC INSTRUMENT Co., 84 Massachusetts Ave., Boston 39, Mass. Model 1010 standard scaler is furnished optionally with a scale-of-100 or scale-of-256, and added scaling assemblies to make either a scale-of-1,000 or a scale-of-4,096 may be

TOROIDS

by

B&W

...to your **SPECIFICATIONS**

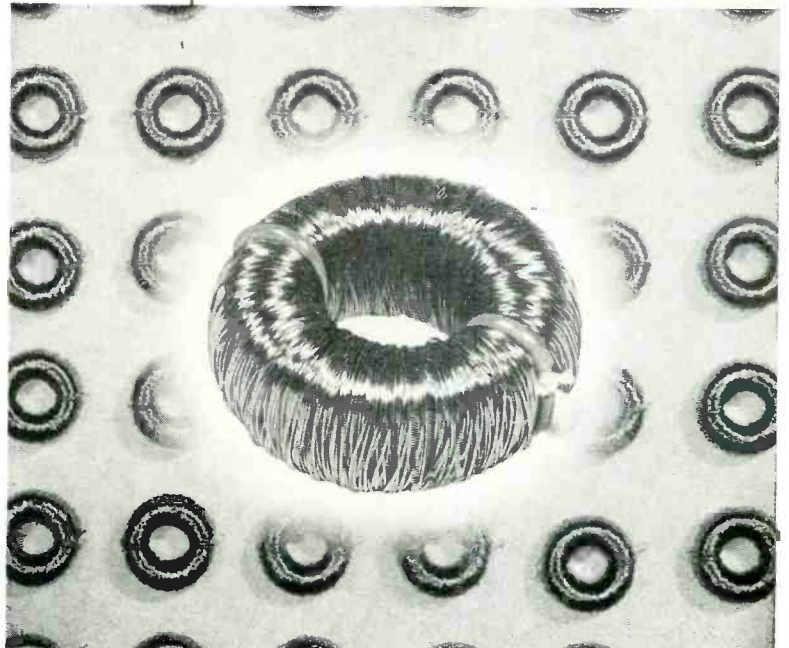

Development of stabilized, high permeability cores of various types and grades, has greatly increased the applications of toroid coils in the low frequency range from 500 cycles to 200 KC. B&W toroids feature high inductance and high Q within a minimum of space and confined electrical field.

These features assure the highest performance in many types of filters or networks.

Over fifteen years background in coil design and manufacture, plus the latest toroidal coil winding equipment, provides a combination that makes it possible for B&W to meet your most exacting requirements. B&W Toroidal Coils are available in open types, shielded, potted or hermetically sealed units in addition to complete filters or networks for specific applications. Our Engineering Department is ready to assist you with your problems in the application of toroids

Write to Dept. EL-100

BARKER & WILLIAMSON, Inc.

237 Fairfield Avenue

Upper Darby, Pa.

COMMUNICATIONS TOWERS

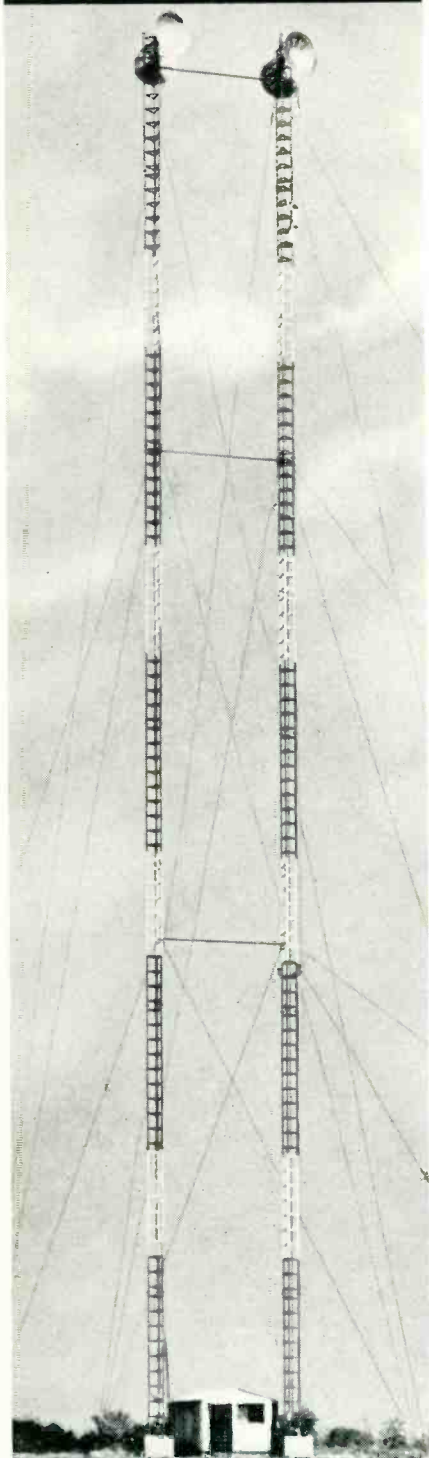

MICRO WAVE RELAY TOWER supports General Electric Relay Equipment between Chicago and Grand Rapids, Michigan, designed and erected by

STAINLESS, INC.
NORTH WALES, PA.
PHONE: NORTH WALES 9859

NEW!

FUNGUS-PROOF

Nylon LACING CORD

resists mold and micro-organisms

- Intensive research in the laboratories of Heminway & Bartlett has resulted in the development of a fungus-proof Nylon Lacing Cord. This new cord — with its special synthetic resin coating — resists the growth of mold and micro-organisms, factors most often responsible for the deterioration of old type linen and cotton lacing cord and the subsequent corrosion and failure of electronic equipment.

Heminway & Bartlett's new special finish Nylon Lacing Cord retains the desirable malleability of wax and yet has a melting point of over 190°F. It is non-toxic to humans.

We'll be glad to send you full information and prices . . . no

THE HEMINWAY & BARTLETT MFG. CO. obligation, of course. Why not write us today!
500 Fifth Avenue, New York 18, N. Y.

Branches: 617 Johnston Building, Charlotte 2, North Carolina; 222 West Adams Street, Chicago 6, Illinois; 77 S. Main Street, Gloversville, New York; 716-32 N. 18th Street, St. Louis, Missouri.

VSWR and RF WATTMETER



SPECIFICATIONS
Frequency Range 50 to over 1000 MCS
Impedance 51.5 or 72 ohms
Connectors Standard connectors supplied are type N to accept UG-21/U attached to RG-8/U and RG-9/U cable. The instrument is supplied on request, with UHF type connectors to accept 82-ISP attached to RG-8/U and RG-9/U cable.
Adapters are available for attaching to 7/8 inch 51.5 ohm coaxial line.

Power Ranges:	Model MM 565	0 to 4 watts
	MM 560	0 to 12 watts
	MM 561	0 to 40 watts
	MM 562	0 to 120 watts
	MM 563	0 to 400 watts
	MM 564	0 to 1200 watts

Accuracy Plus or minus 5% of full scale for RF power.
Plus or minus 10% for V.S.W.R.
Reflection Coefficient Less than 0.01.

MM 560 SERIES

Provides instant assurance of proper functioning of entire RF portion of transmitter, antenna, and transmission line.

This new MicroMatch reads directly the incident power, reflected power, net power to load, and VSWR of the load. Complete \$97.00.

M. C. JONES ELECTRONICS CO.
BRISTOL, CONNECTICUT

Distributed Outside of Continental U.S.A. by RCA International Div., N. Y., N. Y., U. S. A.

specified. The standard unit features a resolving time of less than 5 μ sec. Inputs are as follows: G-M probe with 0.25-v sensitivity and external preamplifier; an adjustable pulse height discriminator; a 2,500-v line and load-regulated h-v supply.



Inert-Gas Thyatron

WESTINGHOUSE ELECTRIC CORP., Bloomfield, N. J. A new grid-controlled, inert-gas rectifier, the type WL-5796 thyatron, is a three-electrode, temperature-free tube designed for industrial control and ignitor firing service. Maximum peak anode voltage, both inverse and forward, is 1,500. Maximum negative control grid voltage before conduction is 250; after conduction, 10. The tube can be used in poly-phase rectifiers on inductive loads with very small or no cushioning circuits. Cathode voltage is 2.5 and cathode heating time is 10 seconds.

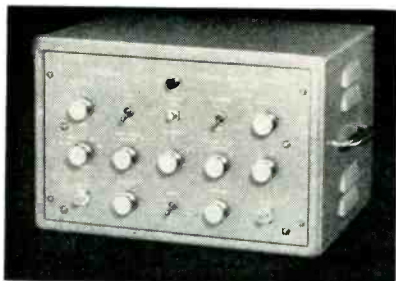

Double-Pulse Generator

BERKELEY SCIENTIFIC Co., 6th and Nevin Sts., Richmond, Calif. Model 902 double-pulse generator pro-

Quality
FOR wires
DEPENDABLE
PERFORMANCE

Rome Cable offers you a variety of electronic wires, fully approved by Underwriters' Laboratories, Inc. and manufactured to one standard of quality... the highest. Complete and modern facilities, coupled with sound engineering, make Rome your best source of supply. For radio or television, in fact any electronic equipment, you can depend upon Rome's quality and versatility of design... wires made to fit your requirements. Typical constructions are illustrated.

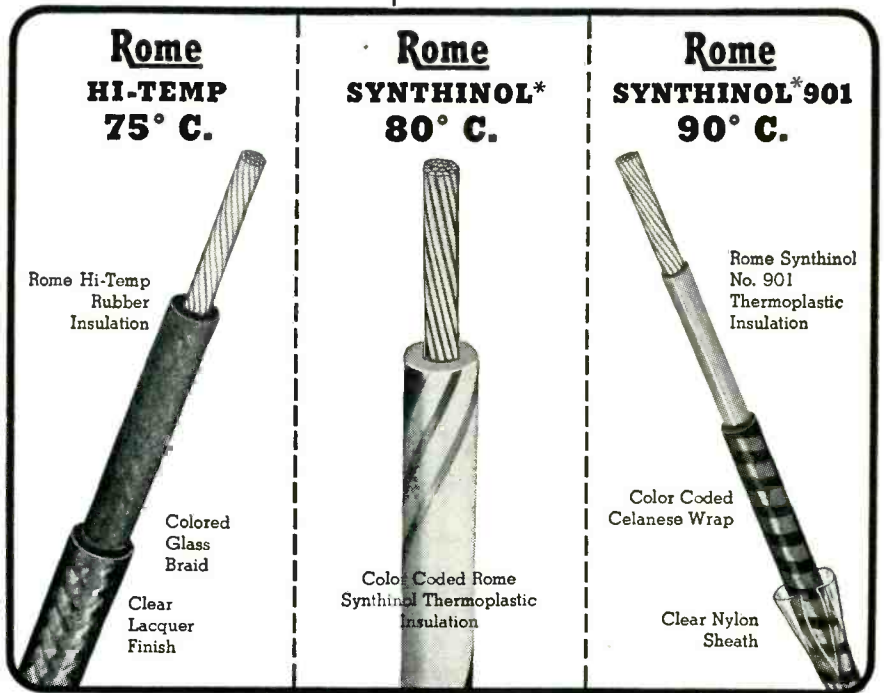

*T. M. Reg

Another First for Rome Cable

Space Saving • 8 Mil Wall • U/L Approved

Color Coded Rome Synthinol No. 901 Thermoplastic Insulation... Clear Nylon Sheath



The first of its type to receive Underwriters approval. Rome Cable's small diameter radio and television hook-up wire is a real space saver. Insulated with an 8 mil wall of Rome Synthinol No. 901, plus a lacquered

braid or Nylon sheath, it is completely approved for 90° C., above and below the chassis, in approved applications. Replaces heavier and larger 1/64" and 1/32" insulations. Sizes 16 AWG to 24 AWG.

IT COSTS LESS TO BUY THE BEST

ROME CABLE CORPORATION

Dept. E10, Rome, N. Y.

• Please send me your Radio Wiring Bulletin.

Name.....

Company.....

Address.....

City..... State.....

ROME CABLE CORPORATION
ROME, NEW YORK



Kahle

specialists in custom-built, ultra-precision
ELECTRON TUBE MACHINERY

KAHLE CUSTOM-BUILDS machines to make the exact tubes you require—from big 20-inchers to tiny sub-miniature—from laboratory types to those for high-speed production. Kahle puts each unit through exhaustive trial runs in our plant to assure trouble-free operation in yours.

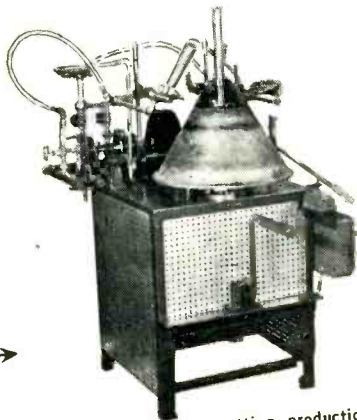

#1540 Single Head Automatic Neck Sealing Machine

For sealing necks to metal cones of metal cathode ray tubes. Operator loads, presses start button. All other operations automatic. Overall height 3'; overall length 2' 6"; overall width 2' 6". Also available as eight-head automatic machine.

We specialize in cost-cutting production-boosting, labor-saving equipment for complete manufacture of cathode ray tubes, standard, miniature and sub-miniature radio tubes, sub-miniature tubes, fluorescent lamps, photocells, x-ray tubes, glass products.

Kahle ENGINEERING CO.

1309 Seventh Street, North Bergen, New Jersey

Consultations invited
Send for our new catalog

let
Scovill
help
you
with
the
tough
ones



ENLARGED TO SHOW DETAIL

Making cold metal go exactly where it's wanted by cold heading frequently requires specialized skills. Take this steel acorn-head screw, for instance. Ordinary cold heading just can't displace such a large amount of metal in the head on such a small threaded section.

Scovill makes a specialty of "tough" cold heading jobs—has the engineers, toolmakers and operators to turn out parts like these to close tolerances, with better finish, at low cost. Send your sample or blueprint for further information.

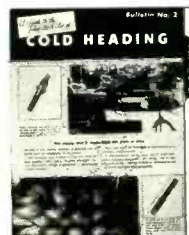

"Guide to the Profitable Use of Cold Heading"—Bulletin No. 2 describes the advantages and limitations of this process for the designer. It's free for the asking.



Recessed Head Screws • Sems Tapping Screws • Standard Machine Screws • Special Cold Headed Parts

SCOVILL FASTENERS AND SPECIAL PARTS

Industrial Fastener Sales, Waterville Division
Scovill Manufacturing Co., Waterville 14, Conn.

Montclair, N. J. • Detroit • Wheaton, Ill.
Los Angeles • Cleveland • San Francisco

LARGE OR SMALL
SQUARE, ROUND OR RECTANGULAR
Coil-Proved

PARAMOUNT
Spiral-Wound
PAPER TUBES

Lengths from 1/2' to 30'
Inside Perimeters, .450" to 25"

PARAMOUNT Paper Tubes facilitate coil winding—insure coil accuracy and stability. Proved by use, they have become standard with leading manufacturers of electrical, radio and electronic products. Here you are sure to obtain the exact size and shape you need for coil forms and other uses... from stock arbors, or specially engineered to your specifications. *Hi-Dielectric. Hi-Strength.* Kraft, Fish Paper, Red Rope, or any combination, wound on automatic machines. Tolerances plus or minus .002" • Also Shellac Bonded Kraft Paper Tubes for absolute moisture resistance.

PARAMOUNT PAPER TUBE CORP.

616 LAFAYETTE ST., FORT WAYNE, IND.

Manufacturers of Paper Tubing for the Electrical Industry

WRITE ON COMPANY
LETTERHEAD FOR
STOCK ARBOR LIST
OF OVER 1000 SIZES

duces two pulses individually controllable in width, amplitude and time relation to each other. Pulse amplitude is individually adjustable from 0 to 50 and 0 to -200 v. Pulse rise time is 0.05 μ sec, decay time 0.10 μ sec, and duration is individually adjustable from 0.15 to 1.5 μ sec. Spacing between the two pulses is continuously variable in two ranges, -0.5 to +3 μ sec. Output impedance is approximately 400 ohms; maximum output voltage, -200 v. Overall accuracy of control calibrations is ± 5 percent over the entire range.

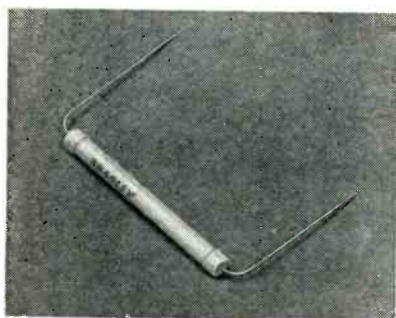

Selenium Rectifier

BRADLEY LABORATORIES, 82 Meadow St., New Haven, Conn., has introduced a new low-current selenium rectifier which features a special plate for use on direct currents in the microampere range. It was developed to provide a highly efficient selenium rectifier for very low current requirements in special equipment such as Geiger counters and c-r equipment. Model number is SE8LA. Rated up to 6,000 v peak inverse, connection series may be used for higher voltages.

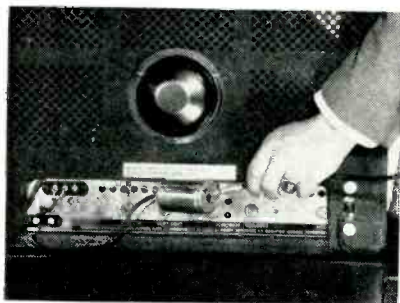

Matching Transformer

BRACH MFG. CORP., 200 Central Ave., Newark, N. J., has developed a 75 to 300-ohm matching trans-



THE HIGH FIDELITY

Magnecorder

Electronic data and test sounds now are recorded for comparison and future reference on low-cost Magnecord tape recordings. Because Magnecordings capture the data as it happens, there's no human error—no lost time. . . . Records faster, cheaper, more accurately!

HIGH FIDELITY—50 to 15 kc . . . No other recorder offers such wide response at such a low price. Special models for your special needs. Write for specifications.

See How "Sound" Research Can Help Improve Your Product!

PROFESSIONAL TAPE RECORDING EQUIPMENT

for

NOISE ANALYSIS VIBRATION TESTS
SOUND IMPULSES TELEMETERING

Send me further information on Magnecorder tape recordings for industrial uses.

Name

Company

Address

City Zone State

Magnecord, INC.

Dept. E 10 360 N. MICHIGAN AVE. • CHICAGO 1, ILL.

SEND THIS COUPON TODAY!

MORE GEO. STEVENS COIL WINDING EQUIPMENT IS IN USE THAN ALL OTHER MAKES COMBINED!

- **MORE OUTPUT . . . LOWER COSTS . . .** from EXCLUSIVE SPEED FEATURE. Universal motors permit variable speeds without changing belts and pulleys. Coil design permitting, speeds as high as 7500 RPM are not uncommon.
- **PORTABILITY.** Conveniently carried from place to place. Machines come mounted on bases to constitute one complete unit.
- **MUCH LOWER ORIGINAL COST.** The same investment buys more GEO. STEVENS machines than any other coil winding machines.
- **LONG LIFE.** Most of the original

GEO. STEVENS machines bought 14 years ago are still operating daily at full capacity.

- **MUCH FASTER CHANGING OF SET-UPS** than any other general purpose coil winding machine. Quickly changed gears and cams save time between jobs.
- **VERY LOW MAINTENANCE.** Replacement parts are inexpensive, can be replaced in minutes, and are stocked for "same day" shipment, thus saving valuable production time.
- **EASIEST TO OPERATE.** In one hour, any girl can learn to operate a GEO. STEVENS machine.

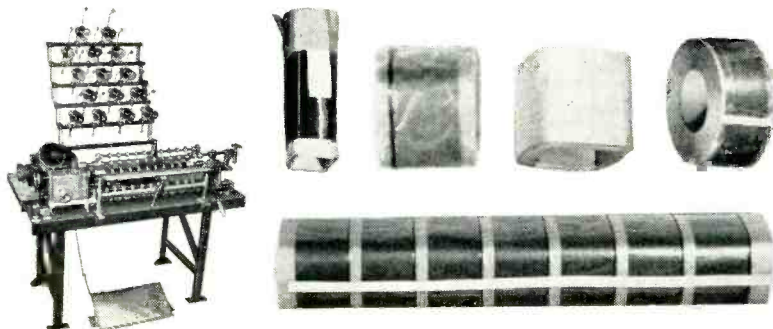

Transformer winder Model 37S multiple winds power, audio, automotive, fluorescent ballast and similar types of coils. Winds wire from No. 18 B&S to 46 B&S up to 9" O.D. Maximum economy is possible by using mandrels up to 30" long. Thirty or more coils may be wound at one time. All turns are accurately registered by Model 50 or 51 6" full vision clock face Dial Counter. Set-ups can be changed in less than 5 minutes. A gear chart is furnished to quickly determine wire spacing.

No loss of turns (an exclusive feature) and accurate margins are assured by a screw feed traverse and an electrically controlled clutch. Highly polished wire guide rollers are ball-bearing mounted for free running. Traverse is quickly adjusted from 1/4" to 6".

Paper feed:—A tilting table for pre-cut paper is furnished making paper feed simple and fast, or a new roll paper feed for extra economy is available at a small additional cost.

Motor equipment:—Variable speed, uniform torque 1/2 H.P. motor with foot treadle control.

Tension equipment:—12 T-1 tensions and spool rack. Tensions will handle 6" spools.

Mounting:—Ground steel channel base ensures rigidity and permanent alignment. Machine is shipped mounted on bench ready for use.

There is a GEO. STEVENS machine for every coil winding need. Machines that wind ANY kind of coil are available for laboratory or production line. . . . Send in a sample of your coil or a print to determine which model best fits your needs. Special designs can be made for special applications. Write for further information today.

*World's Largest Manufacturer
of Coil Winding Machines*

REPRESENTATIVES

Frank Tatro
6022 No. Rogers Ave., Chicago 30, Illinois
Ralph K. Reid
1911 W. 9th St., Los Angeles 6, California
R. F. Staff & Co.
1213 W. 3rd St., Cleveland 13, Ohio

GEO. STEVENS MFG. CO., INC.

Pulaski Road at Peterson
Chicago 30, Illinois

former with high-pass filter action. It is designed to be a perfect termination at channels 2 to 13 but offers a serious mismatch to diathermy and short-wave interference transmissions in the i-f band. A coaxial fitting is provided to make a low-loss connection to RG59/U. The transformer has negligible loss over the complete tv band and a voltage gain of 2 to 1.

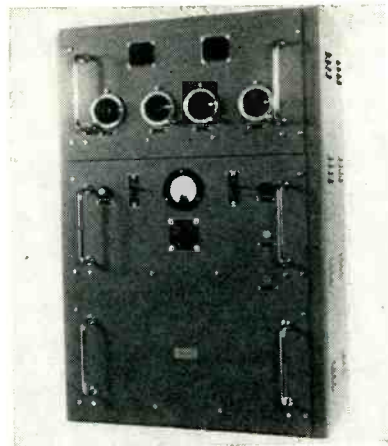

VHF Transmitter

PLESSEY CO. LTD., Ilford, Essex, England. Type PT. 15, a 50-watt vhf transmitter, has a wide field of application in providing radiotelephony communication wherever a compact fixed-station transmitter with a carrier power output of this order is required. Covering the 118 to 132-mc frequency band, the crystal-controlled operational frequency can be varied by insertion of the appropriate crystal.



Preamplifier

PICKERING AND Co., 309 Woods Ave., Oceanside, N. Y., has announced the model 230H compact, small size preamplifier to equalize low frequencies and provide neces-

Gold Plated
TUNGSTEN
 and
MOLYBDENUM
GRID WIRE



Made to meet your specifications... for gold content, diameter and other requirements.

Write for details and list of products



SINCE 1901

SIGMUND COHN CORP.
 44 GOLD ST. NEW YORK

PRECISION POTENTIOMETERS

The linear Type RL-275 illustrated is one of a series ranging from 1 1/4" to 5" in diameter, with resistance ranges of 80 ohms to 500,000 ohms.

GAMEWELL Potentiometers are precision instruments in every respect. They feature extremely close limits in electrical characteristics and mechanical construction, low electrical noise, low torque, and long life—far in excess of 1,000,000 cycles of operation.

All types will operate within specified limits of performance at temperatures -55° C. to +55° C., 95% relative humidity at altitudes up to 50,000 feet. Corrosion resistant materials are used throughout and all insulating parts are fungicided. Our potentiometers meet AN-E-19 specifications.

We invite your inquiries and will gladly study and quote on special requirements.

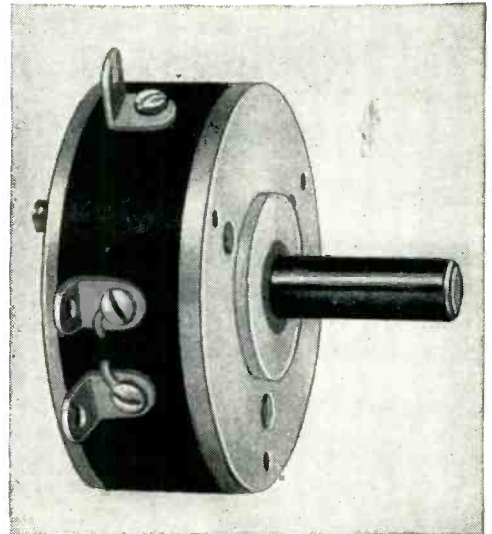







Write for Bulletin F-68.

THE GAMEWELL COMPANY

Newton Upper Falls 64, Massachusetts



SPECIFICATIONS

QUANTITY	DESCRIPTION
	
	
	

*Fred—
 Get these from Anti-Corrosive.
 the Co. that has more than
 7,000 varieties and sizes of
 Stainless Steel fastenings
 IN STOCK!*

FREE! Send for Folder 50A for full information

Anti-Corrosive SINCE 1927
 Metal Products Co., Inc.
Manufacturers of STAINLESS STEEL FASTENINGS
 CASTLETON-ON-HUDSON, NEW YORK

RCA TELEVISION COMPONENTS

THE STANDARDS OF THE INDUSTRY

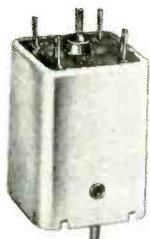

Horizontal Osc. & Sync.
Stabilizer Coil

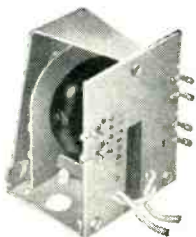

Horizontal Deflection &
High-Voltage Transformer



Deflecting Yoke

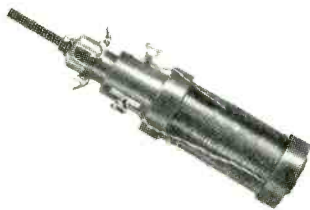

Horizontal Linearity Control

Base your TV designs on RCA performance-proved deflection components

RCA TV Components reflect RCA's vast experience in TV design . . . and incorporate the most advanced engineering features. RCA TV components are unexcelled for wide-angle deflection systems.

All RCA television components are "originals," with electrical and mechanical specifications rigidly held to coordinated circuit and tube

requirements. They are "performance proved" and they are competitively priced.

RCA Application Engineers are ready to work with you in the adaptation of RCA television components to your specific designs. For further information write or phone RCA, Commercial Engineering, Section J428, Harrison, N. J., or your nearest RCA field office.

(EAST) Harrison 6-8000, 415 S. 5th St., Harrison, N. J.

(MIDWEST) Whitehall 4-2900, 589 E. Illinois St., Chicago, Ill.

(WEST) Trinity 5641, 420 S. San Pedro St., Los Angeles, Calif.



RADIO CORPORATION of AMERICA
ELECTRONIC COMPONENTS HARRISON, N. J.

NEW PRODUCTS

(continued)

sary gain for magnetic pickups. It is self-powered, operates with any high-quality, high-input impedance amplifier and installs by plugging in. The unit features low intermodulation and harmonic distortion.

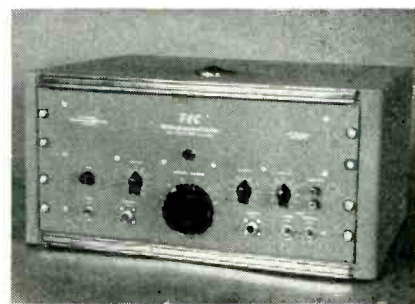

TV Generator

TEL-INSTRUMENT Co., INC., 50 Paterson Ave., East Rutherford, N. J. Type 2111 tv generator is designed to provide a rapid method of production testing tv receivers on all 12 channels. When modulated by a composite video signal it will provide a standard r-f picture signal suitable for use as a final air check of receivers. The picture signal has an associated f-m sound carrier, which may be modulated at 400 cps or with music from an external source. An electronically regulated power supply assures stable performance regardless of line voltage fluctuations between 105 and 125 v. Picture carrier accuracy is 0.01 percent; sound carrier better than ± 4.5 kc of standard on all channels. Picture carrier output is at least 50,000 μ v into a 75-ohm terminated coax cable.



ULF Band-Pass Filter

KROHN-HITE INSTRUMENT Co., 580 Massachusetts Ave., Cambridge 39, Mass., has produced the model 330-A ultralow-frequency band-pass



IF IT'S

here...

IT'S news...

IT'S WORTH
STOPPING TO SEE!

Maybe Industry doesn't maintain show windows on Fifth Avenue or State Street or Wilshire Boulevard like America's great department stores. But your industry has a mighty effective show window... and this is it... this magazine. In these advertising pages alert manufacturers show their wares. Here you will find up-to-the-minute news about products and services designed to help you do your job better, quicker, and cheaper. To be well-informed about the latest developments in your business, your industry... and to stay well-informed... read all the ads too.

**McGraw-Hill
PUBLICATIONS**



ANNOUNCING NEW, MODEL 1401

Plays 10½" Reels!



Complete, for
console installation with
single or dual track heads

\$345⁰⁰

CONCERTONE

■ The professional quality tape recorder you have been waiting for! NAB standards; triodes throughout; 40-15000 cycles at 15", 40-8000 cycles at 7½". Three motors; flutter less than 0.1%; signal-to-noise better than 50 db. Three heads for simultaneous erase, record, playback. Quick change from single to dual track. Write for booklet.

FISHER RADIO CORPORATION • Distributors • 37 E. 47th St., N. Y.

**SMALL
PARTS**

Cost less when made by
MULTI-SWAGE

The economy way to get
a million small parts
similar to these —

Examine the tubular metal parts shown here twice size. If you use anything similar... in quantities of over a million... important savings can be yours. Send us the part and specs. Our quotation will show why the Bead Chain Company's MULTI-SWAGE Process has long been known as the most economical method of making electronic contact pins, terminals, jacks and sleeves. And, why more and more users of mechanical parts (up to ¼" dia. and to 2" length) employ our facilities. WRITE for Data Bulletin.

B THE BEAD CHAIN MANUFACTURING CO.,
Tr. Mark 88 MOUNTAIN GROVE ST., BRIDGEPORT 5, CONN.

New F-S terminal for radio-teletype communication

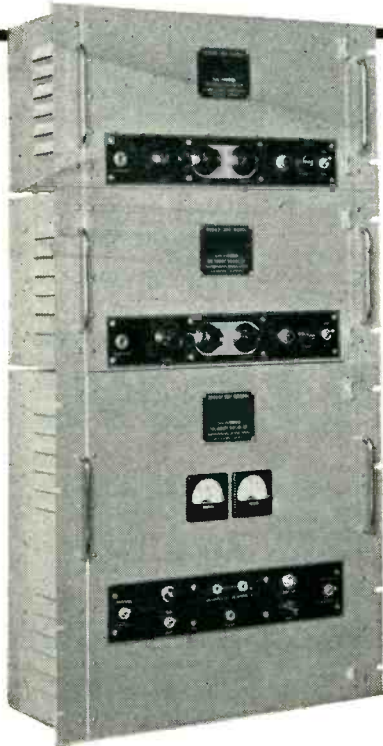

The HK A-4920 frequency shift receiving terminal is a new development of Heintz & Kaufman which provides reliable radio-printer operation on extremely weak signals together with frequency stability normally obtainable only from far more costly equipment.

The terminal is used with two space antennas for diversity reception, and it will directly actuate a radio-printer or other d-c operated devices such as a multiplex keyer.

FEATURES

The terminal consists of two A-4921 crystal-controlled receivers and one A-4922 F-S converter. It has a range of operation from 2 to 24 megacycles with transmitter shifts nominally between 500 and 1000 c.p.s. at keying speeds up to 150 dot cycles.

SENSITIVITY: 1 microvolt or better for a 12 db. signal-to-noise ratio.

SELECTIVITY: An undesired signal only 1.5 kc. from the desired signal is discriminated by 60 db. Image rejection is 60 db. down or better throughout the input signal range.

STABILITY: When recommended crystals are used, the stability of the terminal

will permit operation over a 24 hour period without manual adjustment under the following conditions and with an output signal bias distortion not in excess of 10%:

Ambient temperature variations between plus 10 and 50 degrees C. Line voltage varying from 105 to 125 volts. Signal input level variation (to receivers) from 1 microvolt to 1 volt. Input signal frequency variation (as from transmitter drift) of plus or minus 100 c.p.s.

GENERAL:

Visual and aural tuning system.

Visual observation of signal conditions in each channel.

Electronic selection of the best signal in each channel on a signal-to-noise basis.

For detailed electrical and performance specifications covering the new A-4920 terminal write or wire

Communication Equipment Division

THE ROBERT DOLLAR CO.

50 DRUMM STREET • SAN FRANCISCO, CALIF.

Export: M. SIMONS & SONS CO., INC., 25 Warren Street, New York City • Cable: Simontrice

filter. Both the high and low cutoff frequencies are independently adjustable from 0.02 to 2,000 cps, providing maximum flexibility of adjustment of both the band center frequency and bandwidth. The gain is unity in the pass band and drops to a rate of 24 db per octave outside the pass band. The filter is especially useful for vibration studies and electromedical research, for geophysical and seismological instruments, and in conjunction with any low-frequency phenomenon involving selective amplification.



Versatile VTVM

CHICAGO INDUSTRIAL INSTRUMENT Co., 536 W. Elm St., Chicago 10, Ill. The Multitester illustrated is a vtvm featuring 7 ranges of a-c and d-c volts to 5,000; 0 to a billion ohms in 6 ranges; a capacitance scale from 50 μmf to 5,000 μf and 0 to 500 ma in 4 ranges. Price is \$39.00 and a descriptive folder is available.



SWR Bridge

JAMES MILLER MFG. Co., INC., Malden, Mass. Catalog number 90671 standing-wave-ratio bridge is of the resistance type and is

Standard • STANDARDIZE ON Standard • STANDARDIZE ON Standard



FOR
FREQUENCY

Stability

IN

Mobile

EQUIPMENT

make sure your crystals are made by Standard Piezo.

For years, our Crystals have been standard as original equipment with leading manufacturers and for replacement purposes by large operators of mobile equipment.

Precise, accurate, Standard Piezo Crystals are available for ALL types of mobile communication equipment.

Request catalog E for complete details.



Standard Piezo COMPANY

CARLISLE, PENNSYLVANIA



STANDARDIZE ON Standard

STANDARDIZE ON Standard



Check the spec YOU have to meet

✓	✓	✓	✓	✓	✓	✓
High Temp Tests	Low Temp Tests	Fungus & Humidity Tests	High Alt. Tests	Mildew Resistance Tests	Sand & Dust Tests	Explosion Proof Tests

Building equipment to test products under conditions of high and low-temperature, high altitude and relative humidity is Bowser's business. Because Bowser units can simulate all conditions found on or over the earth, such tough Govt. specs as USAF 41065-B can be taken in stride. All Bowser units are self-contained and will maintain preset conditions automatically.

Why don't you take advantage of Bowser's long experience? Mail the coupon now!

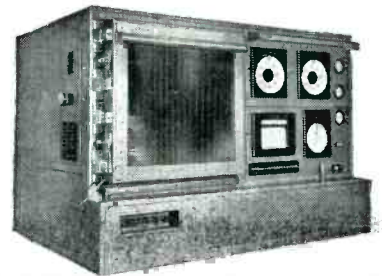

High Temp. Tests	Low Temp. Tests	Fungus & Humidity Tests	High Alt. Tests	Mildew Resistance Tests	Sand & Dust Tests	Explosion Proof Tests
------------------------	-----------------------	-------------------------------	-----------------------	-------------------------------	-------------------------	-----------------------------

I am interested in meeting the tests checked. Send me more information.

Name _____ Pos. _____

Company _____

Street _____

City _____ Zone _____ State _____ ZE

BOWSER INC.

Refrigeration Division

TERRYVILLE • CONN.

Are You An ENGINEER? PROJECT? MECHANICAL? or ELECTRICAL?

... then here's a CAREER opportunity
you can't afford to overlook

If you're an engineer, and a good one; if you are interested in a position of prime responsibility that will pay you remarkably well; if you are eager for an employment opportunity that will associate you with a team of top flight engineers, physicists and production experts; if you are interested in a career job on the engineering staff of one of America's foremost manufacturers of radar equipment . . . then write or wire Mr. William F. Gates, Dalmo Victor Company, San Carlos, California for an interview appointment.

DALMO VICTOR

SAN CARLOS CALIFORNIA

- Check your qualifications with these requirements:
- PROJECT ENGINEERS
 - Superior technical ability and training, 5 years' minimum experience in complex mechanism design. Must be able to make own layouts; aircraft background preferred.
- DESIGN ENGINEERS MECHANICAL
 - Mechanical graduates or equivalent with 3 years' minimum. Must be able to make own design analysis and calculations. Familiarity with aircraft standards and practice highly desirable.
- DESIGN ENGINEERS ELECTRICAL
 - Electrical engineer or physics graduate or equivalent with 2 years' minimum experience microwave design. Must be able to make own design analysis and calculations. Familiarity with wave guide, antenna feed systems, and general microwave measuring techniques required.

Dalmo Victor will assist new employees find suitable housing. San Carlos in the Peninsula area just south of San Francisco, is one of the nation's finest residential districts.

Leading Manufacturers* Specify

COMMUNICATION ACCESSORIES

TOROIDAL COMPONENTS

* Names on request...

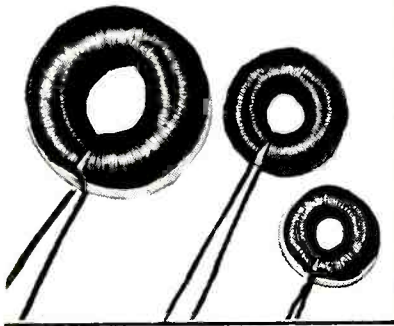

UNCASED COILS

Toroids close-tolerance adjusted to your specifications. Coils are heat cycled to maintain accuracy even in toughest service conditions. Toroids have low T/C characteristics, extremely low magnetic pickup and external field. Coils may be supplied with balanced windings, also can be tapped, or have multiple winding for tight coupled impedance transformation.

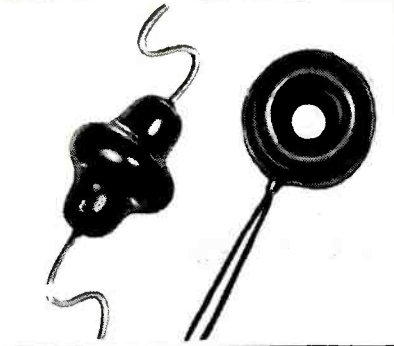

PLASTIC COATED TOROIDS

Another C A C First. Our most progressive customers specify thermo-setting plastic coating for their coils, transformers, and tuned circuits. This tough resilient covering protects the coils and seals out moisture. Just another reason why the people who use toroids year after year specify C A C Toroidal Components.

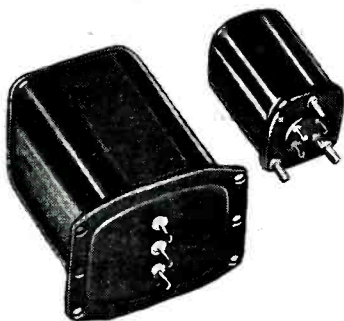

CASED TOROIDS AND FILTERS

Rugged steel cases, construction meeting military specifications. Coils giving highest Q per unit volume and special capacitors provide sharper and more stable filters with a compactness never before possible. A special design for your every requirement.

Send for this FREE booklet today...



COMMUNICATION ACCESSORIES
Company

HICKMAN MILLS, MISSOURI

intended for use with coax lines of either 52 or 75-ohm type. The unit measures 4½ in. × 2½ in. × 1½ in. It will work with any low-range d-c instrument and makes possible an inexpensive means for making measurements of the type necessary with all modern transmitter installations.

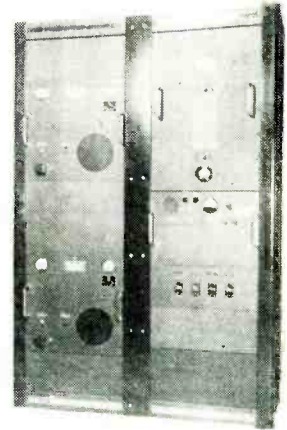

Radio Beacon

AERONAUTICAL COMMUNICATIONS EQUIPMENT, INC., 3090 Douglas Road, Miami 33, Fla., has developed the package-type dual automatic beacon transmitter illustrated. Each unit consists of two 100-watt transmitters (or two 50-watt transmitters), automatic keyer, an automatic transfer unit, and an antenna tuner housed in two standard rack cabinets, especially designed for unattended service.



Oscillosynchroscope

BROWNING LABORATORIES, INC., 750 Main St., Winchester, Mass., an-

ELECTRONICS TECHNICIANS

for

**RADAR, COMMUNICATIONS,
TELEVISION RECEIVERS**

Needed By

RCA SERVICE COMPANY, INC.

A Radio Corporation of America
Subsidiary for U. S. and Overseas

REQUIREMENTS:

- Good Character
- Training in Installation or Maintenance of Radar, Communications or Television
- Give Full Details of Practical Experience

*Qualified Candidates
will be Interviewed Promptly.*

COMPENSATION:

Up to \$7,000.00 a year to start

For Overseas Assignment
With Periodic Review of Base Salary Thereafter

Made up of—

- Base Salary
- Overseas Bonus
- Actual Living and other Expenses
- Accident, Hospitalization, and Life Insurance
- Vacation and Holiday Pay

Qualified technicians seeking connection with leading company having permanent program for installation and service of military equipment, AM, FM, TV transmitters and receivers, and electronic devices, such as electron microscopes, mobile and microwave communications, theatre TV, write full history to:

RCA SERVICE CO., Inc.

Camden 2, New Jersey

Building Block Design!

Successors to the famous 140 series amplifiers, the new ALTEC 1400 series is the most versatile amplifying, preamplifying, mixing group ever designed. Building block design permits combinations to provide 2 to 12 mixing input channels—preamplifiers that can be mounted on the power amplifier chassis or externally—mixing controls that can be mounted remotely from all other apparatus—output at line level, when required, or 35 to 75 watts. Thorough mechanical and electronic design and outstanding quality make the new ALTEC 1400 series perfect for every speech input and public address requirement.

1161 N. VINE ST., HOLLYWOOD 38, CALIF.
161 SIXTH AVE., NEW YORK 13, NEW YORK



THE NEW
1400 SERIES
AMPLIFIERS

1420A AMPLIFIER

1410A PREAMPLIFIER

ALTEC
LANSING CORPORATION

AMPERITE

THERMOSTATIC METAL TYPE

Delay Relays



**PROVIDE DELAYS RANGING
FROM 1 TO 120 SECONDS**

FEATURES:— Compensated for ambient temperature changes from -40° to 110° F . . . Hermetically sealed; not affected by altitude, moisture or other climate changes . . . Explosion-proof . . . Octal radio base . . . Compact, light, rugged, inexpensive . . . Circuits available: SPST Normally Open; SPST Normally Closed.

PROBLEM? Send for "Special Problem Sheet"

Regulators

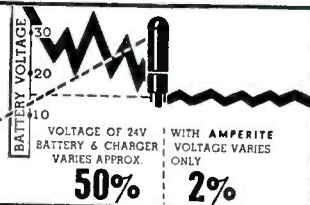

Amperite REGULATORS are the simplest, lightest, cheapest, and most compact method of obtaining current or voltage regulation . . . For currents of .060 to 6 Amps. . . Hermetically sealed; not affected by altitude, ambient temperature, humidity.

Write for 4-page Illustrated Bulletin.

AMPERITE CO., Inc., 561 Broadway, New York 12, N. Y.

In Canada: Atlas Radio Corp., Ltd., 560 King St., W. Toronto

AEROVOX
ALPHA
AMPERITE
ASTATIC
ATLAS
B & W
BELDEN
BELL SOUND
BELMONT
BIRNBACH
BLILEY
BOGEN
BURGESS
BUD
BUSSMANN

PERHAPS AN ALMO-PINION WILL HELP YOU!

(Especially When they're FREE!)

If you want the best equipment—or the lowest priced equipment—to do an electronic job, you can save time and money with a FREE Almo-pinion.



Almo provides a one-source call for all the top lines. You get the impartial opinion of men who know all the competitive makes intimately.



You buy at the same factory prices—and get lots of added responsible service FREE.



You save time. Just a single call, wire, or letter will help you get the best solution to your particular problem. (Or we'll send you all the statistical data on all the competitive makes if you wish).



If you need electronic parts or equipment, ask for a FREE Almo-pinion. See for yourself how you can save time and money. Please address your request to Mr. Smith, Industrial Electronics Department.

CANNON
CENTRALAB
CINAUDAGRAPH
CLAROSTAT
CORNELL DUBILIER
CRONAME
DELCO
DRAKE MFG.
DU MONT LABS.
ELECTRO-VOICE
GENERAL CEMENT
GENERAL ELECTRIC
GREENLEE
HAMMARLUND
HALLICRAFTER
HALLDORSON
HICKOK
I. R. C.
INSULINE
JACKSON
JENSEN
JOHNSON
JONES
J. F. D.
KAINOR
KESTER
LITTELFUSE
MASCO
MC MURDO SILVER
MEISSNER
MILLEN
MINNESOTA MINING
J. W. MILLER
MUELLER
NATIONAL
NATIONAL UNION
OHMITE
PRECISION
PRESTO
QUAM NICHOLS
RADIART
RAULAND
RAYTHEON
REGAL
RIDER
R. M. E.
SAMS
SHURE
SIMPSON
SNYDER
SOLAR
SPRAGUE
STANCOR
STROMBERG CARLSON
SUPREME
TACO
TALK-A-PHONE
TAYLOR
THORADSON
TRIPLETT
TURNER

ALMO RADIO COMPANY

509 ARCH STREET, 4 STORES TO
PHILADELPHIA 6, PA. SERVE YOU

Wilmington, Del. Atlantic City, N. J. West Phila.
6th & Orange Sts. 4401 Ventnor Ave. 6205 Market St.

U. T. C.
UNIVERSITY
UTAH
VACO
VALPEY
VISION
WALDOM
WARD
WARD-LEONARD
WEBSTER
WELLER
WESTON
WORK SHOP
XCELITE



*Write for FREE monthly house organ, the BROADCASTER. Full of news and new products in Electronics.

nounces the model OJ-17 oscillosynchroscope for laboratory use. The high-gain vertical amplifier has a response flat from 5 cycles to 16 mc, extending beyond 30 mc, including the use of a 0.2- μ sec signal delay line. Two completely separate sweep systems permit accurate display of repetitive phenomena with recurrence rates as high as 10 mc, or transient and recurrent pulses as short as 0.5 μ sec. Accurate time measurements may be made by use of 0.1, 1.0, 10 and 100- μ sec timing markers. One compartment of the five-unit cabinet is provided for permanent installation of an Oscillo-Record camera.

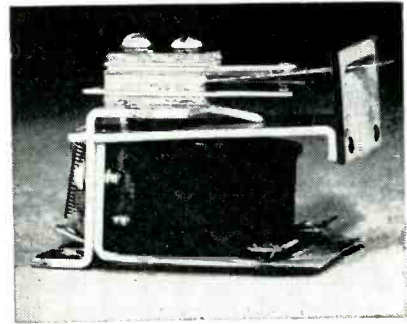

Sensitive Relay

ASSEMBLY PRODUCTS, INC., Chagrin Falls, Ohio. Series 1816 is a sensitive relay with heavy-duty ratings. The coil is 15,000 ohms and operates on 5 ma d-c. Contacts are snap action and will handle 15 amperes, 115 v or 7.5 amperes, 230 v a-c. Designed for high differential between pull in and drop out the relay is normally high speed in action. Contacts are spdt or dpdt.



Random Noise Generators

KAY ELECTRIC Co., Maple Ave., Pine Brook, N. J., announces the microwave Mega-Nodes, a series of

**"But
you can't buy
that kind
of a motor..."**



How many times have you heard somebody that ought to know better say something like that about motors, pumps, compressors or what-have-you? And how many times have you heard somebody else say, "Oh yes you can! I saw just what we need in Blank Company's ad yesterday," Advertising pages in this magazine are packed with news about your business. They contain information about products and services designed to help you do your job quicker, better and cheaper. To be well-informed about the latest developments in your business, your industry... and to stay well-informed... read all the ads too.

**McGRAW-HILL
PUBLICATIONS**



**Engraving
Profiling
VERTICAL
Milling**

Here is the most versatile machine . . .
So simple to operate by unskilled labor.

new hermes
Engravo
graph

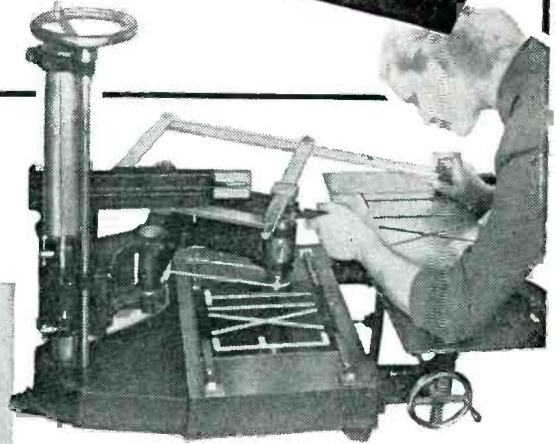

This heavy duty bench type model covers a larger engraving area than any other machine of its kind.

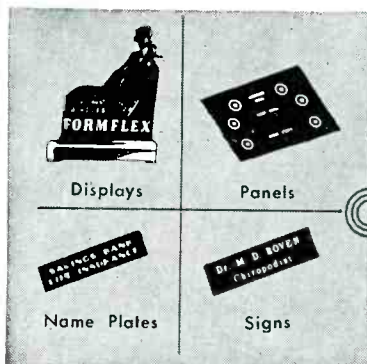

Ⓢ Dies

Send for illustrated booklet H—Dept. No. 29

NEW HERMES 13-19 University Pl.
New York 3, N. Y.

World's Largest Manufacturer of Portable Engraving Machines

**THE NEW
'Economy' OSCILLOGRAPH**

Long the world's most popular oscillograph, the Type S-14 has been redesigned and improved to meet exacting demands of modern research. The NEW Type S-14C 'Economy' Oscillograph is the simplest to operate and maintain, and the most versatile in application. No research or testing laboratory is complete without it.

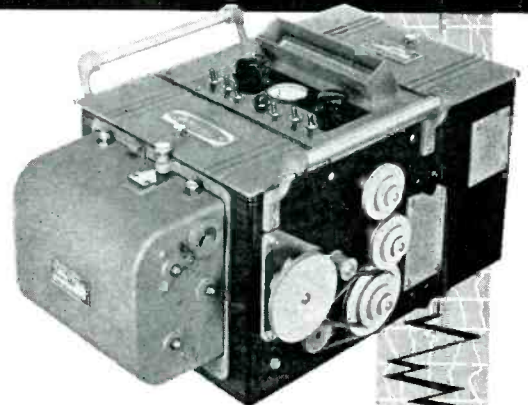

- Wide range of galvanometer types and characteristics. Natural frequencies to 10,000 cps; sensitivities to 50,000 mm per ma; single and polyphase watts.
- Precision optical system for very high writing speeds and high-quality records.
- Continuous-drive magazine for records to 100 or 200 feet long.
- Wide range of record speeds. Any of 9 speeds available by shifting single external belt. Standard speeds: 40, 20, 10, 4, 2, 1, 0.4, 0.2 and 0.1 in./sec.
- Internal motor and gear reducer shock mounted and vibrationless.
- Light-socket operation.
- Daylight loading and unloading.
- Automatic transiend recording attachments.
- Complete list of accessories for extreme versatility.

FOR FURTHER INFORMATION WRITE FOR BULLETIN 2D1-G

Hathaway
INSTRUMENT COMPANY
1315 SO. CLARKSON STREET • DENVER 10, COLORADO

Look to *Permoflux* for the **NEWEST...FINEST...MOST SENSATIONAL** **AUDIO COMPONENTS**

Newest!

MINIATURES AND SUBMINIATURES

The MRB-3 miniature dynamic receiver and microphone has excellent wide-range frequency response characteristics, maintained flat by the Patented Permoflux acoustical damping method. Utilizes a self-formed voice coil. Sensitivity—115 db in 6 cc coupler with 1 m.w. input. Overall diameter 1" — height 1 1/8". Can be supplied with miniature input or output transformers in any impedance.

T1 and T2 Transformers — and Chokes — These sub-miniature units provide power efficiency from 80-90% with high voltage breakdown characteristics and extremely low susceptibility to electrolytic deterioration. Frequency response is ± 2 db from 100 to 8000 \sim . Impedances up to 200,000 ohms and windings with inductive reactances up to one megohm. Ideal for use with Permoflux microphone-receiver units and headsets.



Model MRB-3



Model T1



Model T2

Finest!

STANDARD HIGH FIDELITY SUPER HIGH FIDELITY DYNAMIC HEADPHONES

are world famous and quality-recognized products of Permoflux Corp. Sturdy and comfortable, they are built to withstand excessive shock, high humidities and a wide range of temperatures without impairing their high efficiency and dependable performance. Patented acoustical damping provides a flat frequency response to 4500 \sim in standard models and through 10,000 \sim in Super High Fidelity models. Unparalleled in performance for broadcast studio, aviation, laboratory, and audiometer work.



DHS-17
CAA Approved

MOST Sensational!

ROYAL EIGHT" Compares with any 12" speaker

This average laboratory response curve of the Permoflux 8T-8-1 proves that it compares with the finest speakers regardless of size or price.



8T-8-1
Eight-Inch
Speaker
with the
Blue Cone

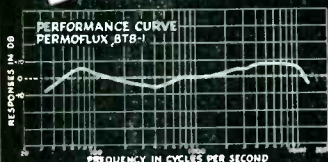

random noise generators designed to produce a known output noise in the frequency range of 2,600 to 12,400 mc. The following waveguide sizes are available: RG48/U, RG49/U, RG50/U, RG51/U, RG52/U. Over the operating range, the vswr of each generator is less than 1.1, with the exception of the RG50/U guide whose vswr goes to 1.19 over about 20 percent of the frequency range. Noise output of each generator is 15.84 db above thermal noise at a waveguide temperature of 32 C.



Low-Frequency Coils

UNITED TRANSFORMER Co., 150 Varick St., New York 13, N. Y., have developed a line of Hi-Q coils for subaudio frequencies. These coils have high Q and stable characteristics for frequencies from 0.1 to 10 cycles. A typical unit provides an inductance of 300,000 henrys with Q of 10 at 0.15 cycle and Q of 30 at 0.5 cycle. It is designed for a 1-volt a-c, 0.1-ma d-c circuit.

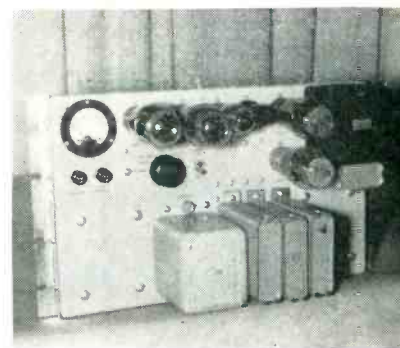

Regulated Power Supplies

GENERAL ELECTRIC Co., Syracuse, N. Y., has announced two new regulated power supplies for tv station

PERMOFLUX
"SOUND IN DESIGN"

PERMOFLUX CORPORATION
4900 W. GRAND AVE., CHICAGO 39, ILL. • 236 S. VERDUGO RD., GLENDALE 5, CALIF.

when you use
the **Audax**
POLYPHASE...

ONE single unit
plays **ALL**
your records
SUPERBLY...
and at less
than the cost
of ordinary
magnetic pick-ups

"The Standard
by which
Others
Are Judged
and Valued"



Microgroove,
78. r.p.m., etc.

- Response 20 to over 10,000 cps.
- Jewel stylus replaceable individually.
- Needle talk practically nil.
- Tracking remarkable.

See it at your
local distributor
or write us

Send for
editorial
reprint
on
POLYPHASE
principles

AUDAK COMPANY

500 5th Ave., New York 18
Fine Music Reproducers Since 1915

**MEMO TO
DESIGNERS**

**THE PATH OF MOST RESISTANCE
FOR ELECTRICITY IS
THE PATH OF LEAST RESISTANCE
for your PURCHASING AGENT**

We're Talking About
JELLIFF ALLOY 1000

This new resistance wire is almost too good to be true. Not only is the Resistivity 1000 ohms/cm² (48% higher than that of the widely-used nickel-chromiums), but it also has such outstanding mechanical and electrical properties that it can easily replace several other alloys now being used in the smaller gages for precision resistors.



This means simplified procurement, stock and inventory procedures — more compact precision resistors — lower cost and longer life for the finished product.

For the full story of Alloy 1000,
write for Bulletin 17



The **FISHER-PIERCE**
**PHOTOELECTRIC
TOWER LIGHTING
CONTROL**

Turn-on 35 ft.-candles—off at 55 ft.-candles—independent of time of day or weather conditions.
Low first cost—negligible maintenance.
3000 watts contact capacity.
Over 20,000 in use for tower and street lighting.
Complete details available — ask for Bulletin 63305.

The **FISHER-PIERCE** COMPANY, Inc.
42 Ceylon St., Boston 21, Mass.

**E-I HERMETIC
SEALING
COMPONENTS**

**NEW! OCTAL
PLUG-IN WAFERS**

Now available in production quantities, E-I Series OBS Plug-in Wafers feature several important new developments. Hollow keys are form fitting and a new hermetic sealing technique makes the seal practically indestructible, even when the pins are bent. The entire assembly is extremely rigid. For complete data, call or write for the E-I illustrated brochure.

STANDARD SIZES	
MODEL	OUTSIDE DIA.
OBS 146	1.460
OBS 125	1.250
OBS 106	1.060

**E-I ELECTRICAL INDUSTRIES
INCORPORATED**
44 SUMMER AVENUE • NEWARK 4, N. J.

"LOOK, SAM,
MEETING TOUGH TEST SPECS
IS NO PROBLEM NOW...
EVEN..."

No. 41065-B

(U. S. A. F.)

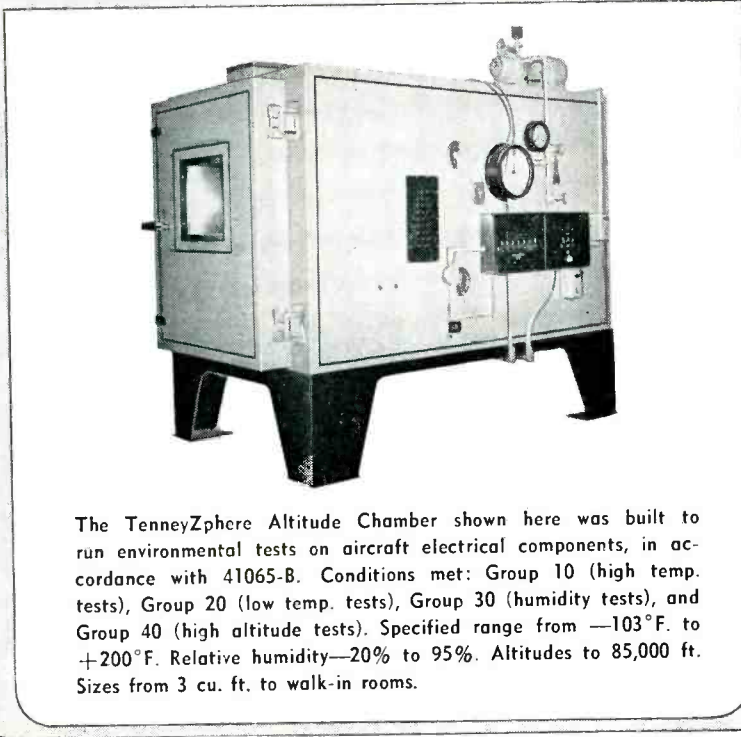

The TenneyZphere Altitude Chamber shown here was built to run environmental tests on aircraft electrical components, in accordance with 41065-B. Conditions met: Group 10 (high temp. tests), Group 20 (low temp. tests), Group 30 (humidity tests), and Group 40 (high altitude tests). Specified range from -103°F. to $+200^{\circ}\text{F.}$ Relative humidity—20% to 95%. Altitudes to 85,000 ft. Sizes from 3 cu. ft. to walk-in rooms.

Experience, hard and practical, is the reason why Tenney can build test chambers to meet the toughest industrial and government specifications. Standard Tenney units accurately control mildew resistance, altitude, explosion-proof, liquid immersion and other tests. Basic systems can be combined for complex conditions. Tenney program control assures absolute fidelity in changing times and conditions; electronic controllers provide high precision regulation. For literature and further information, write to Tenney Engineering, Inc., Dep't. A 26 Avenue B, Newark 5, New Jersey.



Tenney

Manufacturers of Automatic Temperature,
Humidity and Pressure Control Equipment

applications. Both units, types TP-12-A and TP-13-A, feature single-phase input, high current capabilities and low ripple. The TP-12-A can supply 300 to 900 ma at 275 to 300 v with a maximum ripple less than 0.01 v peak-to-peak. The TP-13-A can supply 0 to 300 ma at 275 to 400 v with a maximum ripple of less than 0.05 v peak-to-peak.



Remote-Cutoff Beam Pentode

RADIO CORP. OF AMERICA, Harrison, N. J. Type 5890 is a low-current beam pentode of the remote-cutoff type intended particularly for the voltage regulation of h-v d-c power supplies. It has a maximum d-c plate-voltage rating of 30,000 v, a maximum d-c plate-current rating of 500 μa , and a maximum plate-dissipation rating of 10 watts. The h-v insulation required for its intended service is obtained by the use of a double-ended structure using a suitably designed electron gun consisting of a thermionic cathode and three grids. The plate connection is made to a small cap at the end of the bulb.

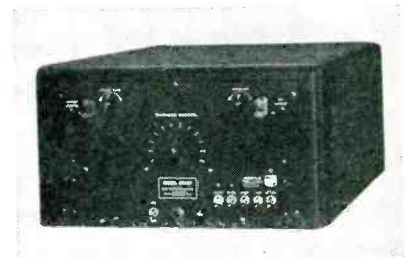

Sweep and Marker Generator

KAY ELECTRIC Co., Maple Ave., Pine Brook, N. J. Model RFP Marka-Sweep is an all-electronic sweep and marker generator espe-

**SPECIALISTS IN
ELECTRONIC GEARS**

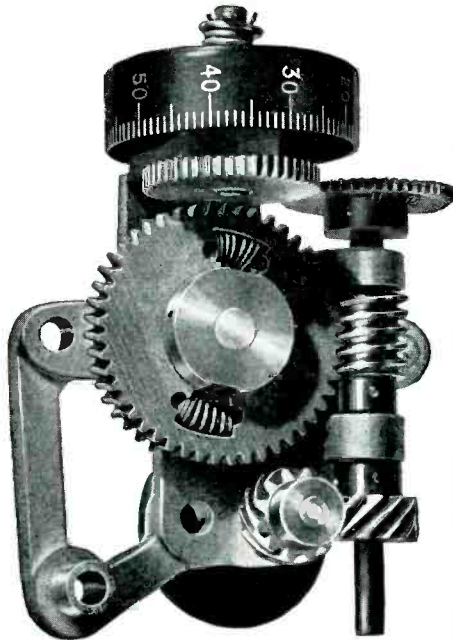

**QUAKER CITY
GEAR WORKS**

1910 N. FRONT ST.
PHILADELPHIA 22, PA.

Save Time, Save Money . . . Use Rogan's Interchangeable
COMBINATION KNOBS

Wide Selection Available From Stock Molds . . . No Tool Charge . . . Fast Delivery



RB-1000 Escutcheon
Branded

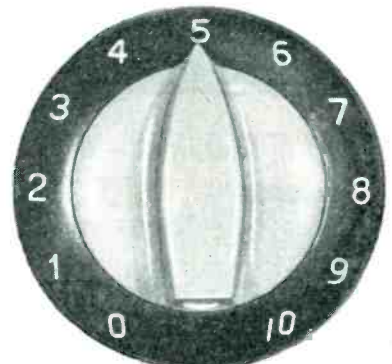

RB-1000 Used in Combination
with RB-31 Knob

Write
For New
Bulletin 104
Showing How
Rogan Knobs
Can Help
Solve Your
Knob
Problems

Illustration shows two of the many combination branded knobs from Rogan's huge selection. Available from stock with assorted markings readily adaptable to electronic and other related equipment. Can be furnished in matching or contrasting color combinations. Supplies from stock molds, no tool charge. Fast delivery, low cost. Send for complete details.

ROGAN BROTHERS

2504 IRVING PK. BLVD.
CHICAGO, 18, ILLINOIS

Compression Molders and Branders of Plastics

VULCAN
ELECTRIC HEATING UNITS

FINNED STRIP

For use in blower type electric unit heaters, as oven or space heaters in dryers, pump rooms, switch towers, etc.

From 10½" to 42½" overall.
500 watts to 3250 watts.
for 115 and 230 volts
Steel sheath and fins (rust resisting)

For use where sheath temperature will not exceed 750° F.

VULCAN
ELECTRIC COMPANY
DANVERS 10 MASS.
TRADE MARK
VULCAN
MADE

HEART OF A TIP JACK . . .

IS THE SPRING CONTACT

Johnson Design, Materials
Mean Longer Life, Better Service

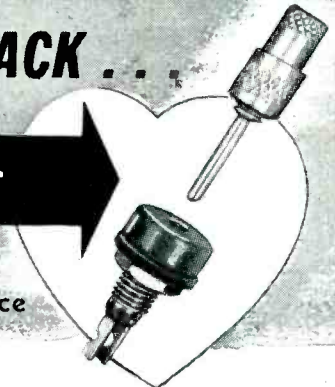

Next time you need Tip Jacks, remember the two important advantages JOHNSON Tip Jacks offer.

First, contact in the JOHNSON Tip Jack is made along the entire length of the phone tip or test prod, and remains unchanged despite insertion of oversize tip, excessive binding forces or long use. Second, JOHNSON uses heat treated beryllium copper contacts which remain smooth acting, have low resistance and retain high spring tension.

Although other Tip Jacks may look like those made by JOHNSON, only JOHNSON offers you heat treated beryllium copper contacts of this unique design.

The insulated style with strong molded Plaskon head, (illustrated) is available in ten attractive colors. They are also available without head for mounting directly in equipment, as well as in a variety of other types. In all of them JOHNSON machined parts are of highest quality, with close fitting threads, smooth finish, plated to comply with any specifications.

JOHNSON makes many other jacks and plugs, such as "banana" styles for military or commercial applications, as well as plug and jack board assemblies, connectors, etc. Manufacturers are invited to write for free samples and catalog information.



JOHNSON . . . a famous name in Radio!
E. F. JOHNSON CO., WASECA, MINNESOTA



HIGH QUALITY WORKMANSHIP

REASONABLE PRICES

SPEEDY DELIVERY

*America's Foremost Crafters
Of Scientific Equipment*

SQUARE WAVE GENERATOR—Model SG5

An inexpensive step frequency type square wave generator for accurate high speed testing of response characteristics of wide band amplifiers, wide band oscilloscopes, television video amplifiers, etc.



— FEATURES —

1. Five fixed output frequencies of 50, 1000, 10,000, 100,000 and 500,000 P.P.S.
2. Individual calibration control for each frequency.
3. Rise time .05 microseconds.
4. Output voltage 0.8 to 8 volts peak to peak.
5. Small, compact, portable—completely AC operated.

SIZE 9" x 11" x 11½" WEIGHT 20 lbs.

INSULATION RESISTANCE TESTER—Model MQ5

A small compact portable battery operated insulation resistance tester employing a high quality vibrator power supply as a source of high potential. Operates completely from two small self contained 1½ volt batteries. Total current drain only 15 milliamperes.

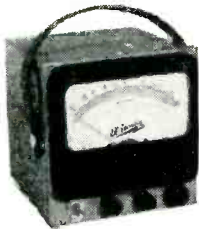

— FEATURES —

1. Resistance Range—5000 megohms at 2000 volts. D.C. potential.
2. Meter—4½" rectangular type with 3⅞" scale length.
3. Small and light in weight.
4. Provided with leather strap for carrying.
5. Operates completely from two self contained scale volt dry batteries.

SIZE
5" x 5⅜" x 6"

WEIGHT
2 lbs.

AUDIO OSCILLATOR—Model TE200K

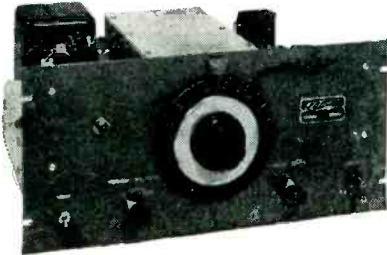

Frequency Coverage — 20 cycles to 200,000 cycles in four ranges.
 Frequency Dial — 6" diameter, direct reading, with planetary drive.
 Output Voltage — 10 Volts maximum.
 Calibration Accuracy ± 2% of dial setting indication.
 Distortion — 3% or less across standard load at any frequency setting and at any output voltage up to maximum.
 Hum Level — Minus 50 DB or better.
 Standard Load — 1000 ohms resistive.
 Frequency Response ± 1 DB from 20 to 200,000 C.P.S.
 Drift ± 2% or better.

SPECIAL FEATURES

1. Electronically regulated power supply for stable operation under varying line voltage conditions.
2. No electrolytic capacitors are used.
3. Designed for stable continuous operation under the most adverse conditions.
4. Mounts in standard relay rack or table cabinet.

We maintain a fully equipped laboratory embracing the finest in modern high quality test instruments—complete facilities for testing every type of equipment manufactured—facilities for temperature and humidity tests from —80°F to +165°F and humidities up to 95%.

Take advantage of our 15 years of experience in the Specialized Electronics Field. We are one of the oldest commercial manufacturers of Nucleonic Instruments and Capacity Operated Electronic Burglar Alarms.

15,000 SQ. FEET OF FLOOR SPACE AND A MODERN, FULLY EQUIPPED PLANT TO SERVE YOU

FOR FURTHER DETAILS WRITE EL-TRONICS, INC. 2649 N. HOWARD ST. PHILADELPHIA 33, PA.

NEW PRODUCTS

(continued)

cially suitable for production alignment of tv tuners and overall alignment of complete receivers. A 12-position channel switch selects extremely narrow pip-type crystal-positioned picture and sound carrier markers as well as the desired 15-mc wide swept oscillator output. Sweep outputs are from maxima of approximately 0.5 v for the 70-ohm unbalanced output and 1.0 v for the 300-ohm balanced output down to minima suitable for aligning the most sensitive receivers.



Transmitting Tube

GENERAL ELECTRIC Co., Syracuse, N. Y. Type GL-5680 transmitting tube is designed for use as a power amplifier in transmitters for long-range navigation. The tube is forced-air cooled and may be operated at maximum ratings at frequencies as high as 5 mc. In pulsed r-f power-amplifier service it can deliver a peak power output of 90,000 watts at 15,000 volts under typical operating conditions.

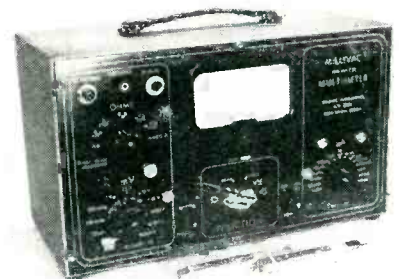

V-T Multimeter

MILLIVAC INSTRUMENTS, Box 3027, New Haven, Conn. Type MV-73B

ANNOUNCING the
RAWSON-LUSH
Rotating-Coil
GAUSS METER

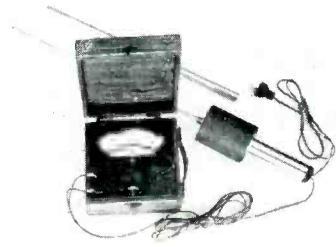

Tiny coil (approx 3mm diameter) rotates in the magnetic field to be measured. The voltage generated is rectified in a synchronous rectifier and deflects a Rawson high sensitivity voltmeter with scale calibrated in kilogausses.

FEATURES

- 1) Simple operating principles, simple to maintain.
- 2) Compact and portable, just one meter and the long probe unit.
- 3) Ranges 0.1/1.2/4/12/40/120 kilogausses, all on one instrument.
- 4) Practically point measurement of field.
- 5) Can be inserted in any gap wider than 1/4", and will reach the center of 37" diameter gap. Coil protected by stationary outer tubing.
- 6) Measures direction of field as well as intensity.
- 7) Guaranteed accuracy 1% or better.
- 8) Low price \$325 complete with meter.

**RAWSON ELECTRICAL
INSTRUMENT COMPANY**

111 Potter St. Cambridge, Mass.

STANCOR TRANSFORMERS

Specified as original components by the biggest radio and TV set makers in the industry.

They have to be good!

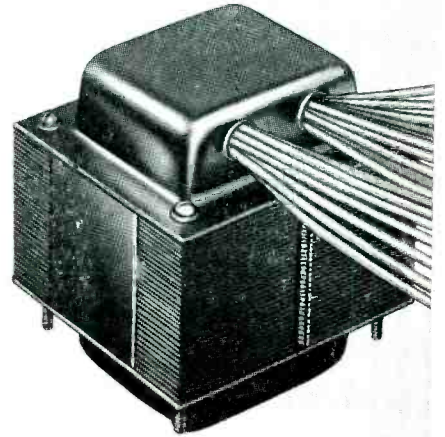

WRITE.
inquiries promptly answered



STANDARD TRANSFORMER CORPORATION
3578 ELSTON AVENUE, CHICAGO 18, ILLINOIS

Lavite **STEATITE
CERAMIC**

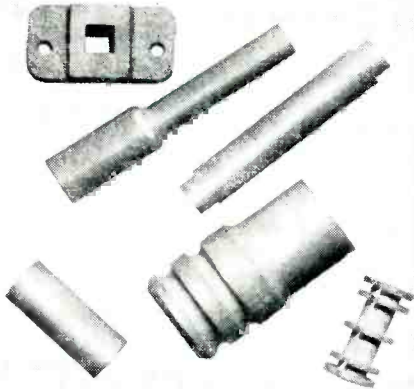

Design engineers and manufacturers in the radio, electrical and electronic fields are finding in LAVITE the precise qualities called for in their specifications . . . high compressive and dielectric strength, low moisture absorption and resistance to rot, fumes, acids, and high heat. The exceedingly low loss-factor of LAVITE plus its excellent workability makes it ideal for all high frequency applications.

Complete details on request

D. M. STEWARD MFG. COMPANY

Main Office & Works: Chattanooga, Tenn.
Needham, Mass. • Chicago • Los Angeles
New York • Philadelphia

add **REAL TENSION CONTROL** to
COIL WINDING OPERATIONS



INSTALL

PAMARCO

**Wire DeReeling Tensions
on Your Present Machines!**

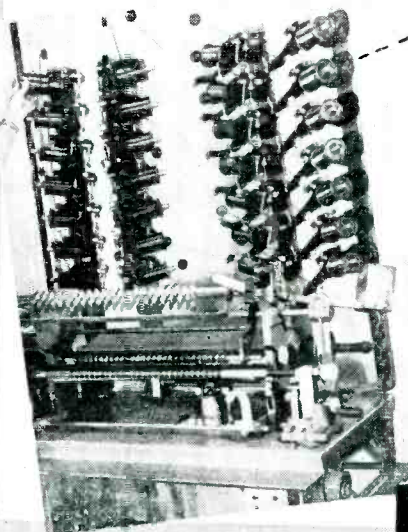

Pamarco DeReeling Tensions increase the efficiency of coil winding departments in two important ways. Production quantity is increased because each machine accommodates more coils and can often operate at higher winding speeds. Production quality is improved because Pamarco free-running action practically eliminates wire breakage and shorted turns. No special skill or tools are required to operate Pamarco-equipped winding machines. Simple thumb screw can be set instantly for any wire gauge. For all the facts on money-saving Pamarco DeReelers, just call or write. Complete data will reach you promptly!

— SPECIFY

PAMARCO

FOR PERFECT COILS

**Manufactured Exclusively by
PAPER MACHINERY
& RESEARCH • INC**

1014 OAK ST., ROSELLE, NEW JERSEY

WINDING DEVICES FOR TEXTILES AND ELECTRONICS

New radiation instruments in the modern tempo



The New Roentgen Rate Meter

The new Roentgen Ratemeter has been designed to indicate rate of beam intensity in roentgens per minute. Two probe selections are offered, each to cover four ranges of intensity, one 3-10-30-100, the other 30-100-300-1000 r per minute and both may be used interchangeably with the same meter.

Calibrated in the international r, the instrument provides a means to make accurate and quick determinations of beam intensity for many laboratory applications.

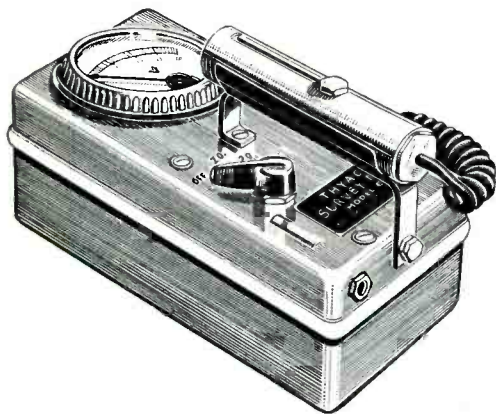

The New Model 389 Thyac Survey Meter

A stable and versatile beta gamma survey meter incorporating new features and advantages in a portable instrument. The design provides compact, light weight, waterproof construction which meets severe military ruggedness and corrosion resistant requirements. It adapts itself for sensitive exacting laboratory measurements as well as for field measurements.

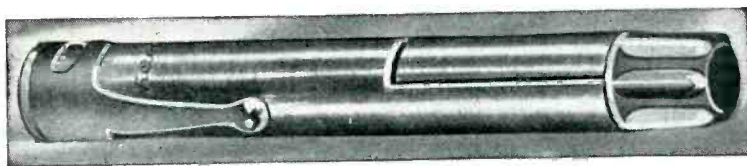

100 and 200 r hi-intensity chambers used with Model 392 charger

The Model 506 pocket ionization chamber is designed to meet the need for a compact dependable chamber for measurement of radiation in the 100 r and 200 r ranges. These chambers offer accurate readings of high intensity at energy responses of 40 KV and above, reliable for high dosage and are tamper proof.

The Victoreen Instrument Co.

5806 HOUGH AVENUE • CLEVELAND 3, OHIO

NEW PRODUCTS

(continued)

vacuum tube multimeter, which measures voltage, current and resistance, combines unusual versatility with high sensitivity. It has a full-scale sensitivity of 10 mv for d-c and a-c voltage measurements. In the high-frequency range up to 300 megacycles it has a maximum sensitivity of 25 mv. Its current range is between 1 μ a and 10 amperes. As an ohmmeter it can measure from 0.5 ohm to 2,000 megohms. The instrument is equipped with three probes.



Power Frequency Amplifier

KEITHLEY INSTRUMENTS, 1507 Warrensville Center Road, Cleveland 21, Ohio. Model 105 Meter Matcher is a power frequency amplifier that will develop 150 volts rms across a 2,000-ohm resistive meter load and adds only a 0.15-percent maximum error to the measurements. Output and input voltages are in phase except for the small displacement caused by the meter current in the internal output impedance, about 0.006 degree for a 2,000-ohm resistive load at 60 cps. Detailed information is given in a recent four-page bulletin.

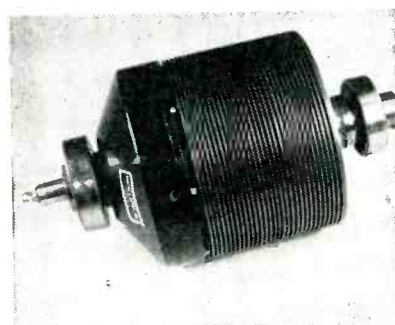

Hysteresis Clutch

DUNCAN AND BAYLEY, INC., 785 Hertel Ave., Buffalo 7, N. Y. New PM series hysteresis clutch is capable of synchronous operation with

• Compare for results!
 • Compare for price!
 • and you'll choose the GREEN ENGRAVER



only \$215*

The Green Engraver offers great speed and convenience. Quickly cuts up to four lines of letters from 3/64" to 1" on curved or flat surfaces whether made of metal, plastics or wood... operates by merely tracing master copy—anyone can do an expert job. Special attachments and engineering service available for production work. Just the thing for radio, electronic apparatus and instrument manufacturers.

For quality engraving on

- Panels • Name Plates • Scales
- Dials • Lenses • Molds • Instruments

... also does routing, profiling and three dimensional modeling.

*Price does not include master type and special work holding fixtures.

GREEN INSTRUMENT CO.
363 Putnam Ave.
Cambridge, Mass.

Ideal for
ANTENNA CONNECTIONS
PHOTO-CELL WORK
MICROPHONE CONNECTIONS

JONES
SHIELDED TYPE
PLUGS & SOCKETS

LOW LOSS PLUGS AND SOCKETS FOR HIGH FREQUENCY CONNECTIONS. SUPPLIED IN 1 AND 2 CONTACT TYPES:

101 Series can be furnished with 1/4", .290", 5/16", 3/8" or 1/2" ferrule for cable entrance. Knurled nut securely fastens unit together. Plugs have ceramic insulation and sockets have bakelite. Quality construction. Fine finish. Assembly meets Navy specifications.

For full details and engineering data ask for Jones Catalog No. 17.

JONES MEANS Proven QUALITY



P-101-1/4
S-101

Howard B. Jones Division
CINCINNATI MANUFACTURING CORPORATION
CHICAGO 24, ILLINOIS
SUBSIDIARY OF UNITED-CARR FASTENER CORP.

It's a Fact...

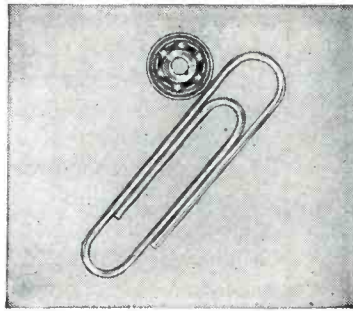

Ground
miniature bearings
are obtainable
and at **NO**
EXTRA COST

The major development of the decade in anti-friction bearings made possible by

- * Production skill and "know-how."
- * The last word in machine tools and equipment.
- * Precision grinding spindles of 100,000 rpm and more.

RESULT:

The smooth performance and accurate geometry of GROUND Bearings is now available in sizes as small as 1 mm (.040") bore x 1/8" O.D. with the millionths inch refinement of ABEC-7.

"The smaller the bearing the better it runs."

New Hampshire Micro Ball Bearings, Inc.

5 Main Street • Peterborough, New Hampshire

Microwave Transmission Problems
are a cinch with
Waveflex Waveguides



The WAVEFLEX waveguide incorporates all of the advantages of rigid waveguides while offering the additional feature of flexibility. Designers of radar, FM, and television transmission equipment have discovered that this combination of properties simplifies many of their design problems.

WAVEFLEX waveguides offer lower attenuation loss, excellent impedance match, and extreme flexibility without loss of efficiency. They are made in ac-

cordance with joint Army-Navy specifications. Let us work with you in developing special waveguides for your special applications.

Literature on request
TITEFLEX, INC.
410 Frelinghuysen Ave., Newark 5, N. J.

A
Titeflex
Product

New Miniature Insulated Terminals

to help your miniaturization program

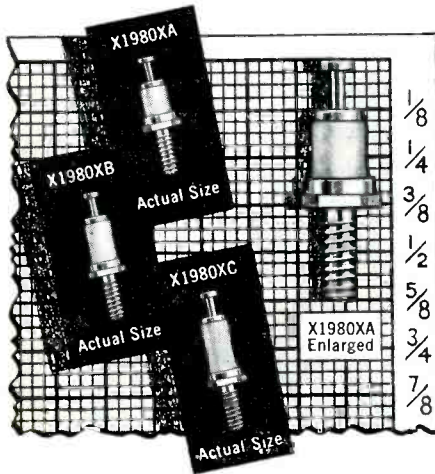

Featuring extremely small size combined with excellent dielectric properties, three new miniature insulated terminals are now available from CTC.

Designed to meet the requirements of the miniaturization programs now being carried out by manufacturers of electrical and electronic equipment, the terminals come in three lengths of dielectric and with voltage breakdown ratings up to 5800 volts. In addition, they have an extremely low capacitance to ground.

The X1980XA is the smallest terminal, having an over-all height of only three-eighths of an inch including lug. Insulators are grade L-5 ceramic, silicone impregnated for maximum resistance to moisture and fungi.

All terminals have hex-type mounting studs with 3/48 thread or .141" OD rivet style mounting. Mounting studs are cadmium plated, terminals are of bright-alloy plated brass.

Write for additional data.

custom or standard the guaranteed components

CAMBRIDGE THERMIONIC CORP.
437 Concord Ave., Cambridge 38, Mass.
West Coast Stock Maintained By: E. V. Roberts,
5014 Venice Blvd., Los Angeles, California

NEW PRODUCTS

(continued)

zero slip. It provides a stable, long-life, proportional clutch means that can deliver desired torques continuously for given levels of control current independent of slip-heat loss. Fractional horsepower units up to 1/2 hp are available for industrial work such as tension control, machine tool drives, dynamometers, and various duty cycles requiring continuous high-heat dissipation as well as synchronous driving upon demand.

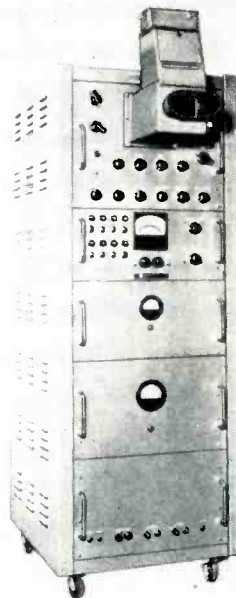

C-R Oscilloscope

ALLEN B. DUMONT LABORATORIES, INC., Clifton, N. J. Type 293 c-r oscilloscope is designed for the impulse-testing of h-v transformers, insulators, lightning arrestors, and other equipment designed to withstand surge potentials of great amplitude. Driven, logarithmic sweeps may be initiated from an external signal, internal signal, by manual pushbutton or from any point in the cycle of the 60-cycle line voltage. Sweep duration is adjustable in steps from 0.5 to 1,000 μ sec. Bandwidth of both the X and Y axes is essentially uniform from d-c to 25 mc.

Literature

Coax Cable. Andrew Corp., 363 E. 75th St., Chicago, 19, Ill. Bulletin 39 treats type 738 ultralow-loss

EMSCO ENGINEERED RADIO TOWERS

FOR AM, FM, VHF, UHF, MICROWAVE, TELEVISION AND RADAR

Emsco Towers are available for all types of broadcast and communication service. Backed by years of fabricating experience, EMSCO towers are engineered for safety, performance and economy. Bolted construction and hot dip galvanizing insure long life, low maintenance cost and maximum electrical conductivity. Self-supporting triangular and square towers and guyed triangular towers are available in heights up to 1,000 feet with wind loadings up to 60 lbs. RMA design.

Shown here is an Emsco Type 2RT 120-foot 40" RMA design tower installed for Southwestern Bell Telephone Co. in Dallas, Texas. →

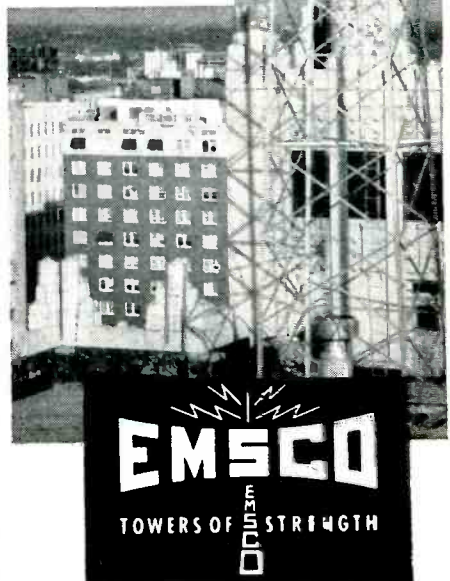

EMSCO
TOWERS OF DIVERSITY AND STRENGTH

EMSCO DERRICK & EQUIPMENT COMPANY
LOS ANGELES, CALIFORNIA
Houston, Texas • Garland, Texas

SENSATIONALLY NEW!

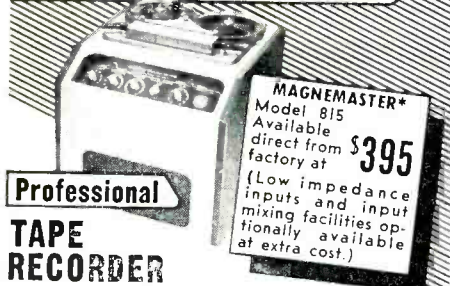

MAGNEMASTER*
Model 815
Available
direct from \$395
factory at
(Low impedance
inputs and input
mixing facilities op-
tionally available
at extra cost.)

Professional

**TAPE
RECORDER**

The **MAGNEMASTER*** Console

Featuring

- Two-speed two-direction operation!
50 to 15,000 cycles at 15 in. per sec.
50 to 10,000 cycles at 7½ in. per sec.
- Dynamic range better than 50 db!
- Single or dual track recording without changing heads!
- Simultaneous monitoring off tape while recording (optional)!

Other MagneMaster features include: Separate heads for erase, record and monitor • Guaranteed lifetime head alignment • Shuttle speed in both directions • Synchronized brakes for instantaneous stop • No overshoot or tape spillage during play or shuttle • Flutter ± 0.05% at 15 in. per sec.; ± 0.1% at 7½ in. per sec. • Lifetime self-adjusting spring clutches • Gentle non-slip non-pinching drive system.

Write today for complete literature. *Trade Mark Reg.

AMPLIFIER CORP. of AMERICA
398-7 Broadway, New York 13, N. Y.

TEST TV TRANSMISSION and RECEPTION Latest TELEQUIP

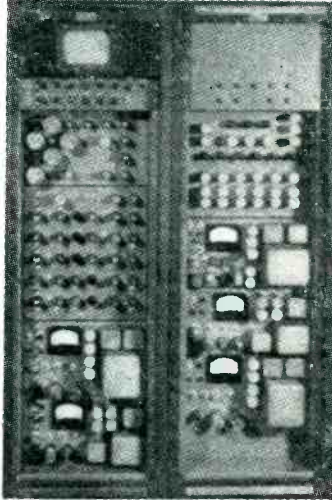

**SYNC GENERATOR
and MONOSCOPE**

with

**Monoscope Picture Generators
and Distribution Panel**

Produces regular pictures used with TV transmitters. Gives synchronizing, driving and blanking signals for testing, research and development work, with monoscope controls and distribution signals for use at various points of testing.

Invaluable to manufacturers of TV receivers and broadcasting units for checking faults not likely to be observed by other methods. Can be used at transmitting stations as auxiliary unit. Available either in combination or as separate units.

Now used by *Admiral, Motorola, Zenith, and many leading manufacturers of television equipment.*



Send for this illustrated monograph completely describing the new Telequip Sync Generator and Monoscope

TELEQUIP RADIO COMPANY

2559 WEST 21ST STREET • CHICAGO 8, ILLINOIS

Working with Inert Gases?

Linde HELIUM • NEON
ARGON • KRYPTON • XENON

Now available in commercial-size cylinders in addition to glass bulbs. Write for information on sizes, prices, rigid purity tolerances, special rare gas mixtures...

THE LINDE AIR PRODUCTS COMPANY
Unit of Union Carbide and Carbon Corporation
30 East 42nd Street **LI 4** New York 17, N. Y.
In Canada: Dominion Oxygen Company, Limited, Toronto

The term "Linde" is a registered trade-mark of The Linde Air Products Company.

GRANT ELECTRONIC EQUIPMENT SLIDES..

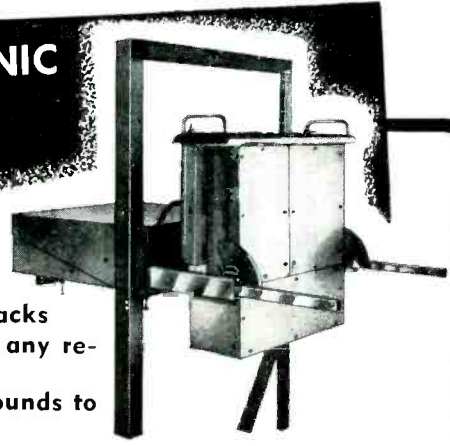

- for Chassis, Consoles, and Racks
- a standard slide to meet any requirement
 - slides to carry from 25 pounds to 2,000 pounds

Outstanding Advantages:

1. Continuous ball bearing motion.
 2. Closely fitted slides eliminate chassis rattle.
 3. Available with special locking device to lock slide in extended position and increase accessibility to all parts.
 4. Allows 90 degree pivot for simplified servicing.
- Single or double acting slides • side or under-carriage mounting types • slides with locking and pivoting devices

Consult with our engineering department on any slide problem
WRITE DEPT. E 10 FOR COMPLETE ILLUSTRATED INFORMATION



GRANT PULLEY & HARDWARE Co.
33-39J 57th STREET, WOODSIDE, L. I., N. Y.

Representatives in all major cities

The foremost name in Sliding Devices

CONSTANT RESISTANCE HIGH POWER RATING TERMALINE COAXIAL LOAD RESISTORS

51.5 ohms DC to 4000 mc—5 watts to 2500 watts

The constant resistance (Low VSWR) of the TERMALINE resistor make it the ideal dummy load and standard resistor at UHF and VHF. Design is such that normal reactance is put to work producing a pure resistance over an extremely wide frequency range. Acting as a "bottomless pit" for RF energy, thousands of TERMALINE units are in daily use with high frequency transmitters.

SIX MODELS AVAILABLE

Model	Cont. Power Rating	Input Connector
80-5F	5 watts	UG-23B/U
80-5M	5 watts	UG-21B/U
80A	20 watts	UG-23B/U
81	50 watts	UG-23B/U
81B	80 watts	UG-23B/U
82	500 watts	Adaptor to fit UG-21B/U supplied.
82C	2500 watts	21B/U supplied.

Other adaptors or cable assemblies for any standard coaxial line available.

All TERMALINE units, except Model 82C, are self-cooled and require no auxiliary power. Substantial quantity discounts.

LITERATURE UPON REQUEST

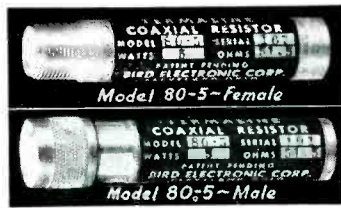

Size 3 3/8" x 3/4" dia.

Very handy in lab and production test. At signal generator levels and below 5 watts, this is the last word for low VSWR.



NEW PRODUCTS

(continued)

coaxial cable that is 7/8 in. in diameter and semiflexible. Mechanical and electrical characteristics, impedance, power rating standing-wave ratio and a table of efficiency vs frequency are given. Several accessories are also described and illustrated; and a price list for all may be found in bulletin 58.

British Specifications. The Radio Industry Council, 59 Russell Square, London, W.C. 1, England, recently issued a series of private specifications for the use of the British radio industry. Specification No. RIC/111 covers fixed, wirewound, noninsulated resistors; RIC/112—fixed composition resistors, grade I; RIC/113—fixed composition resistors, grade II; RIC/131—tubular fixed capacitors (paper dielectric); and RIC/132—stacked foil mica fixed capacitors.

Reference Book. Harrison Radio Corp., 10 West Broadway, New York 7, N. Y. The Radio's Master is a 1,300-page hard-cover-bound reference book and buyer's guide for the electronics industry. It describes and illustrates the products of better than 90 percent of all manufacturers of electronic parts and equipment. Prices and specifications as well as an index are included. Copies will be sent free to any purchasing agent or chief engineer who writes on company letterhead.

Radiation-Detection Densitometer. Photovolt Corp., 95 Madison Ave., New York 16, N. Y. Bulletin 490 covers model 400-R radiation-detection densitometer which is self-contained and operates with barrier-layer photocell without amplification. The unit described is designed for the accurate measurement of density of dental-size x-ray films as employed in film badge systems for personnel monitoring in radioactivity laboratories and x-ray installations.

Receiving Tubes. Radio Corp. of America, Harrison, N. J. Form 1275-E is a 24-page booklet covering more than 450 receiving tubes and picture tubes including more than 50 new types. It provides quick and easy reference to the

BIRD ELECTRONIC CORP.
Instrumentation for Coaxial Transmission
1800 East 38th Street • Cleveland 14, Ohio
West Coast Representative • NEELY ENTERPRISES • Hollywood 46, Calif.

Arc Resistance

135
SECONDS

HYSOL 6000

For Screw Machine Components, Gears and Punched Press Parts

A New Insulating Material with Outstanding Electrical Properties

An extremely high dielectric strength coupled with resistance to moisture and chemical attack make this new material ideal for electrical insulation. Hysol 6000 has good dimensional stability and does not require fabric backing. Available in rod, tube, sheet and casting resin form, Hysol 6000 may be exposed to 140° C for 100 days without embrittlement. Write for technical details and samples.

ELECTRICAL PROPERTIES

Power Factor	0.005 at 60 cycles
Dielectric Constant	3.70 at 60 cycles
Loss Factor	0.009 at 60 cycles
Dielectric Strength	350 volts/mil.
Arc Resistance	135 seconds

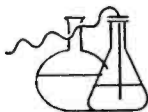

PLANTS AT
OLEAN, AND
SMETHPORT, PA.

houghton
laboratories, inc.
OLEAN, NEW YORK

BIRTCHEr

STAINLESS STEEL - LOCKING TYPE

TUBE CLAMPS

Stainless Steel

Corrosion Proof



83 VARIATIONS

Where vibration is a problem, Birtcher Locking TUBE CLAMPS offer a foolproof, practical solution. Recommended for all types of tubes and similar plug-in components.

More than three million of these clamps in use.

FREE CATALOG

Send for samples of Birtcher stainless steel tube clamps and our standard catalog listing tube base types, recommended clamp designs, and price list.

THE BIRTCHEr CORPORATION
5087 HUNTINGTON DR. LOS ANGELES 32

ON THE JOB AT THE FAMOUS BELL "LABS"

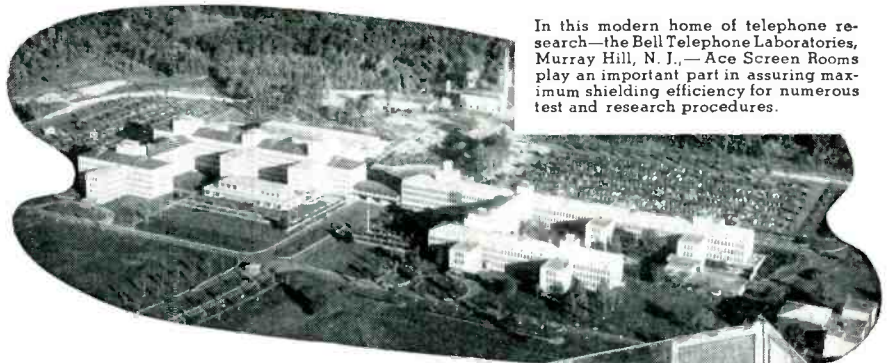

In this modern home of telephone research—the Bell Telephone Laboratories, Murray Hill, N. J.—Ace Screen Rooms play an important part in assuring maximum shielding efficiency for numerous test and research procedures.

Better Attenuation

... AT NO GREATER COST!

Designed to exacting wartime laboratory standards, supplied in ready-built "knock-down" form for installation in a few hours, Ace Screen Rooms provide a minimum of 100 db. attenuation from 0.15 to 1000 mc. Total cost is no greater than that of "homemade" screen rooms of far lower efficiency. Numerous sizes are available and rooms can readily be moved or enlarged as required. Write, wire, or 'phone for details.

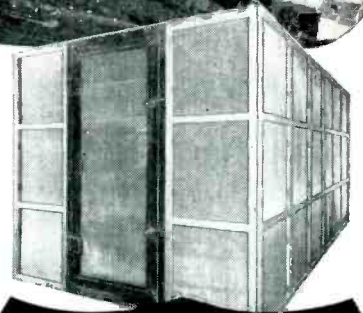

ACE
READY-BUILT "UNIT CELL"
SCREEN ROOMS

ACE ENGINEERING & MACHINE CO.

3642 N. Lawrence St.

Philadelphia 40, Pa.

REgent 9-1019

The New STAVER MINI-SPRING

TRADE MARK REG. AND PAT. PEND.

A quality
Tube
Guard
that is
Bargain
Priced

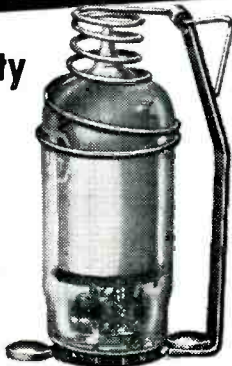

Gives support two ways—Keeps pressure downward and gives sideway support. The spring action is constant and resilient permanently. Send for catalog sheet.

THE
Staver
COMPANY
INCORPORATED

91 PEARL ST. • BROOKLYN 1, N. Y.
ULSTER 5-6303

The Key to SUBMINIATURE TRANSFORMER PROBLEMS

DIMENSIONS:..... 7/16" x 3/4" x 5/8"

WEIGHT:..... Less than 1/3 of an ounce

TYPES:..... input, interstage, output, reactor

Prompt Engineering Attention
To Your Subminiature Problems

UNION ELECTRIC PRODUCTS CO.

24 EDISON PLACE

NEWARK 2, N. J.

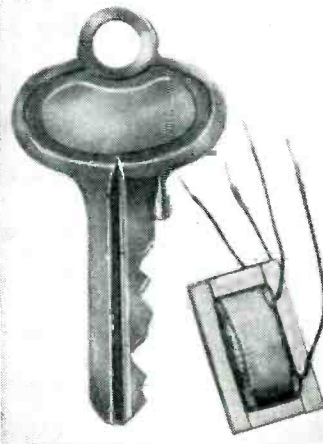

Pioneer in Radio Engineering Instruction Since 1927

CAPITOL RADIO ENGINEERING INSTITUTE

An Accredited Technical Institute

ADVANCED HOME STUDY
AND RESIDENCE COURSES IN
PRACTICAL RADIO-ELECTRONICS
AND TELEVISION ENGINEERING
Request your free home study or
resident school catalog by writing to:

DEPT. 2810B

16th and PARK ROAD, N. W.
WASHINGTON 10, D. C.

Approved for Veteran Training



2 KW VACUUM TUBE BOMBARDER OR INDUCTION HEATING UNIT



For Only \$650.

Never before a value like this new 2-KW bench model "Bombarder" or high frequency induction heater . . . for saving time and money in surface hardening, brazing, soldering, annealing and many other heat treating operations.

Simple . . . Easy to Operate . . .
Economical Standardization of
Unit Makes This New Low Price
possible.

This compact induction heater saves space, yet performs with high efficiency. Operates from 220-volt line. Complete with foot switch and one heating coil made to customer's requirements. Send samples of work wanted. We will advise time cycle required for your particular job. Cost, complete, only \$650. Immediate delivery from stock.

Scientific Electric Electronic Heaters are made in the following range of Power: 1-2-3½-5-7½-10-12½-15-18-25-40-60-80-100-250KW.

*Scientific
Electric*

Division of

"S" CORRUGATED QUENCHED GAP CO.

107 Monroe St., Garfield, N. J.

NEW PRODUCTS

(continued)

characteristics and socket connections for each tube type, as well as a classification chart which groups the tubes according to their family class, their functions, and their filament or heater voltages, and thus facilitates determination of the type designation of a tube for a desired purpose. Price is 10 cents.

Variable Transformers. The Superior Electric Co., Bristol, Conn., has released bulletin P550 featuring the complete line of standard Powerstat variable transformers. Maximum display is given to product photographs, performance curves, graphs, wiring diagrams and similar descriptive illustrations. A complete rating chart occupying the back cover provides engineers and purchasing agents with a quick selector index.

Acoustical Apparatus. Audak Co., 500 Fifth Ave., New York 18, N. Y., announces its new 1950 catalog, a four-page brochure embracing its Polyphase model reproducers, also tuned ribbon and heavy duty pickups and cutting heads. All models are illustrated and list prices are given.

Contact Switches. Guardian Electric Mfg. Co., 1621 W. Walnut St., Chicago 12, Ill., recently issued a bulletin dealing with a line of contact switches. Numerous line drawings and charts are employed to give information relative to sizes, designs and materials available in standard contact blades, lug adapters and insulating separators.

Radio and TV Catalog. General Cement Mfg. Co., 919 Taylor Ave., Rockford, Ill. Catalog No. 154 features over 5,000 radio and television products and service aids. The 64 pages are well illustrated and prices of all items are included.

Electronic Calculation. International Business Machines Corp., 590 Madison Ave., New York 22, N. Y., now has available two recent publications: *Electrons at Work*, and *Fundamentals of Electronic Calculation*. The former describes briefly the operation of

**"We have found
Metex Electronic Gaskets
excellent for HF currents
inexpensive to assemble."
Sylvania Electric Products Inc.**

Sylvania has been using Metex gaskets for over a year as conductive shields for their TR tubes used in radar and micro-wave ranging equipment.

To quote their experience: "We have found Metal Textile knitted wire gaskets excellent for conducting high frequency currents without boundary arcing. The gaskets are resilient, and yet do not deform too readily. Best of all, the material is inexpensive to assemble through soft soldering techniques."



A Sylvania Electric TR tube showing Metex gasket loose and in position

The properties—electrical and physical—which make Metex Electronic Gaskets effective in this, and other demanding HF and UHF applications are due to their being made from *knitted* (not woven) wire mesh. The hinge-like action of the knitted mesh permits controlled resiliency of the finished gaskets. These can be die-formed to close dimensional tolerances, when required. There is practically no limit to the metal or alloy which can be used.

If the equipment you are manufacturing or designing requires a resilient conductive or shielding material, our engineers will welcome the opportunity of working with you. A letter, addressed to Mr. R. L. Hartwell, Executive Vice President and outlining your requirements, will receive immediate attention.

METAL TEXTILE CORPORATION
641 EAST FIRST AVE., ROSELLE, N. J.

World's Largest Stock of
ELECTRONIC

SUPPLIES



Components—
Instruments—
Ham Gear—

Increasing thousands of engineers, industrial plants, broadcast stations and government agencies depend on **NEWARK**. Here is a fast and friendly service, competent technical help, lowest possible prices—**EVERYTHING YOU NEED** in one dependable and centrally located buying source.

Write for our latest bargain-packed flyers, available to amateurs, experimenters and other users of electric equipment.

NEWARK
ELECTRIC COMPANY

323 W. Madison St. Dept. G-100
Chicago 6

A
TIME-TESTED
DEPENDABLE
SOURCE
FOR

HIGH-PRECISION FRACTIONAL H.P. INSTRUMENT-TYPE
MOTORS & GENERATORS
PRODUCED TO ORDER

GOVERNOR CONTROLLED
SELF-SYNCHRONOUS
DRAG CUP
VELOCITY & ACCELERATION
DC & AC TACHOMETER
SHUNT
SERIES
COMPOUND
PERMANENT-MAGNET
SPLIT-FIELD
SEPARATELY EXCITED
UNIVERSAL
INDUCTION
RELUCTANCE
HYSTERESIS
ONE, TWO & THREE PHASE
DC & AC SERVO
TOTALLY ENCLOSED
AC DYNAMICALLY BRAKED
REELMOTORS

ONE, TWO, THREE & FIVESPEED
SYNCHRONOUS MOTORS

Experienced for years in meeting customers' exacting requirements for high-precision instruments designed by engineers of ability and ingenuity, and manufactured with extreme care and skill. Over 500 different basic types may be varied to meet your own unique requirements of use, either electrically or physically.

ELECTRIC INDICATOR CO.

PARKER AVENUE
STAMFORD, CONNECTICUT

PRODUCTION LINE TESTING

OF

SERVOSCOPE

SERVOMECHANISMS



SERVO CORPORATION OF AMERICA

NEW HYDE PARK
LONG ISLAND
NEW YORK

INVALUABLE IN RESEARCH

RAPID INSPECTION ON THE PRODUCTION LINE

A SERVO ANALYZER

- STANDARD RANGE: .1 TO 20 CYCLES PER SECOND
- SINE WAVE
- MODULATED CARRIER
- 50 TO 800 CYCLES
- SQUARE WAVE
- READS DIRECTLY
- SERVO LAG OR LEAD IN DEGREES

You Are Invited To Attend The Second Annual
AUDIO FAIR

at the

Hotel New Yorker, New York City, October 26, 27, 28, 1950

The event of utmost interest and importance to Broadcast Engineers, Recordists, Sound-on-Film Men, Public Address Men, Audio Hobbyists and Distributors and Dealers.

Presenting again, under one roof, an industry-wide display and demonstration of the latest and best of audio equipment, components and accessories.



FREE REGISTRATION

BANQUET THURS.—OCT. 26 7:30 PM

Sponsored by the AUDIO engineering society
in conjunction with its

ANNUAL MEETING AND CONVENTION

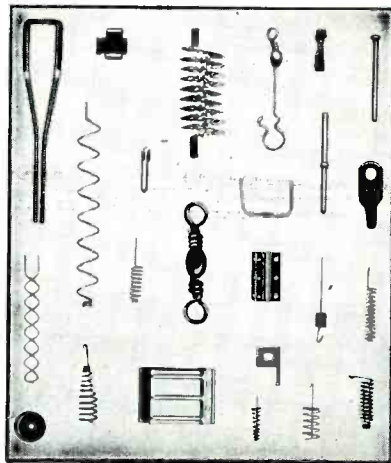

SMALL PARTS

Filaments, anodes, supports, springs, etc. for electronic tubes. Small wire and flat metal formed parts to your prints for your assemblies. Double pointed pins. Wire straightened and cut diameter up to 1/8-inch. Any length up to 12 feet.

LUXON fishing tackle accessories.

Inquiries will receive prompt attention.

ART WIRE AND STAMPING CO.

227 High St.

Newark 2, N. J.

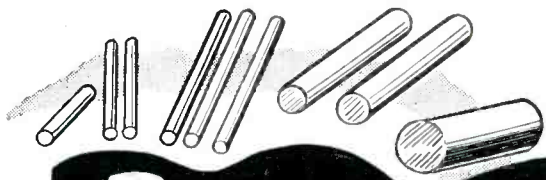

Precision Rod Cutting at High Speed

with the New DI-ACRO ROD PARTER

The DI-ACRO Rod Parter further increases the applications of "DIE-LESS DUPLICATING" as a cost-cutting, time-saving production technique so well established by DI-ACRO Precision Benders, Brakes and Shears.

Do you require precision?—The DI-ACRO Rod Parter holds tolerance to .001" on duplicated cuts. The ends are square, and roundness is maintained.

Do you want speed?—The Rod Parter exceeds output of other methods with equal accuracy, on rods and bars up to 5/8". Torrington Roller Bearings incorporated in an exclusive multiple leverage arrangement provide remarkable ease of operation in both heavy and light materials.

"PARTS OFF" MANY MATERIALS

All hot and cold rolled rods
Stainless steel
Chrome Molybdenum
Aluminum Brass
Copper Bi-metals
Many types of plastics
Fibre Rubber
Wood

See Di-Acro Exhibit—BOOTH 1603
Nat'l Metal Exposition, Chicago, Oct. 23-27
or write us for 40-page Catalog



O'NEIL-IRWIN MFG. CO.

321 EIGHTH AVENUE • LAKE CITY, MINNESOTA

the electronic tube and its application to electronic calculators and business machines; the latter discusses commercial and technical applications of the company's electronic calculating machines, and describes some of the work of the IBM technical computing bureau.

Photoelectric Colorimeter. Photovolt Corp., 95 Madison Ave., New York 16, N. Y. Bulletin 409 describes and illustrates the model 401 Lumetron photoelectric colorimeter, an instrument designed for accuracy, ease and speed of operation in colorimetric and turbidimetric analysis. The bulletin gives a list of applications, a price list and a list of available accessories and replacement parts.

Transformers and Related Components. Standard Transformer Corp., Elston, Kedzie and Addison, Chicago 18, Ill. The June 1950 edition of the company's catalog of transformers and related components for radio, sound and industrial applications is available. This 20-page illustrated booklet lists complete electrical and physical specifications of more than 400 part numbers. Also included is a complete price list and handy charts. The company's tv components are listed in a separate tv catalog and replacement guide, also available in a seventh edition.

Circuit Breakers. Heinemann Electric Co., Trenton 4, N. J. Equipment bulletin No. 3410 describes in 12 pages a line of fully magnetic nonthermal, nonenclosed, general purpose circuit breakers. Illustrations charts, diagrams, graphs and cutaway drawings portray these one-, two-, and three-pole breakers for general industrial use. Time overload curves and coil resistance curves are also included for convenience in selecting the breakers for specific needs. In addition to terminal construction, the following types of coils connections are described: series overload, calibrating tap, shunt trip and relay trip.

Solderless Connectors. Buchanan Electrical Products Corp., 1290

NEW 12 CHANNEL TELEVISION TRANSMITTER Capable of MUSIC Modulation

PRICED AT A
NEW LOW OF
\$495.⁰⁰



TYPE 2111

- The ONLY 12 channel TV transmitter that has a sound carrier capable of MUSIC modulation with full 40 KC swing.
- Has standard 75 microsecond pre-emphasis.
- All picture carriers are crystal controlled within 0.01% and modulation of picture carrier is by means of standard RMA Composite Picture Signal.
- Has standard rack mounting panel; power supply fully regulated.
- Just the thing for rapid TV checking on all 12 channels and for checking receivers for tone, speaker rattle and freedom from microphonics.

Write for Type 2111 Data Sheet for Full Details

Manufacturers of a Complete Line of TV Test Equipment



Tel-Instrument Co. Inc.

50 PATERSON AVENUE • EAST RUTHERFORD, N. J.

The Improved 1951

Concertone RECORDER



Model 1401

"just like
being there"

- Equalization conforms to NAB recommended standards • Extended frequency response—40 to 15,000 c.p.s. \pm 2db • Tape noise down to random level • More powerful drive motor • Improved braking system • Monitors directly from tape while recording • Plays up to 10 1/2" NAB reels • Write for Bulletin No. 103.

MODEL NO. 1401—Complete for console installation, with dual track heads. **\$345.00**
Manufactured by USER'S NET COST



Berlant Associates

4917 W. Jefferson Boulevard
Los Angeles 16, California

■ Important person and professional Opportunities for experienced

ELECTRONICS ENGINEERS

A broad program of research, design and development in new electronic fields with vast commercial applications by the manufacturer of Freed-Eisemann radio phonographs and television receivers provides an opportunity for gaining valuable experience in new electronic concepts and techniques, under the direction of scientists of international repute. Adequate facilities, pleasant conditions and attractive salaries make this an opportunity for personal as well as professional advancement. Many openings experienced electronic engineers . . . including:

- PROJECT PHYSICIST for fundamental electron tube research. Ph.D. or M.S. degree and extensive technical experience in the field of photo-electric, secondary emission, solid state, electron and physical optics.
- SENIOR ELECTRONICS ENGINEER AND JUNIORS: B.S. or M.S. degree. three to five years experience in television, radar, and display circuits.
- PROJECT ENGINEER: Capable of designing low-power transmitters and receivers, AM, FM and UHF.

Furnish complete resume of education and experience, salary required to Director of Research.

FREED RADIO CORPORATION
200 HUDSON STREET • NEW YORK 13, N. Y.



NEW Clippard PC-4
Capacitance Comparator
Checks, Grades and Sorts
Condensers of Every Type
—Paper, Mica, Oil Filled,
Ceramic, Electrolytic.

Now... UNSKILLED OPERATOR CAN GRADE UP TO 8000 CAPACITORS DAILY!

The PC-4, companion to the well known Automatic Resistance Comparator PR-4, is a NEW high speed and extremely accurate aid in the never ending battle for higher quality and lower production costs. An unskilled operator can check, grade or sort as many as 8000 capacitors of ANY TYPE, daily, within an accuracy of 0.2%. Ease of operation reduces inspection time to an absolute minimum.

Completely self-contained, the PC-4 requires no outside attachments other than a Standard Capacitor against which the "unknowns" are to be checked. Operates on 110 Volt—60 cycle AC. Range—100 mmfd to 1000 mfd. Size 18" x 12" x 12". Weight—approximately 35 lbs. For complete details write for Catalog Sheet 4-E.

PRICE
\$525.00
F.O.B. CINCINNATI

Clippard

INSTRUMENT LABORATORY, INC.

1125 Bank Street

Cincinnati 14, Ohio

MANUFACTURERS OF R. F. COILS AND ELECTRONIC EQUIPMENT

HIGH VOLTAGE POWER Supplies

Up to 250,000 volts

A.C. or RECTIFIED and FILTERED

**SPECIAL INDUSTRIAL X RAY EQUIPMENT
FOR INSPECTION • GAGING • ANALYSIS . . .**

We will Design, Engineer and Manufacture to your requirements.

BRACKE-SIEB X RAY COMPANY INC.

293 B THIRD AVENUE

NEW YORK 10, N. Y.

MANUFACTURERS

MOLDED AND FABRICATED

INDUSTRIAL RUBBER PRODUCTS

BUMPERS • BUSHINGS • EXTRUSIONS
GASKETS • GROMMETS • MOLDS • RINGS
ROLLS • SHEET • SLAB • SPRING • SPONGE
TIRES • TUBING • VACUUM CUPS • WASHERS

THOUSANDS OF
ITEMS IN STOCK
SINCE 1919

ATLANTIC INDIA RUBBER WORKS, INC.
571 WEST POLK STREET • CHICAGO 7, ILLINOIS.

Write Dept. E for Complete Catalog #44—All Phones: HARRISON 7-8290

INDUSTRIAL
RUBBER
PRODUCTS



VIBRATORS!

By every test

ATR

is Best!

ATR

**AUTO RADIO
VIBRATORS**

have Ceramic Stack Spacers



A COMPLETE LINE OF VIBRATORS . . .

Designed for Use in Standard Vibrator-Operated Auto Radio Receivers. Built with Precision Construction, featuring Ceramic Stack Spacers for Longer Lasting Life.

Backed by more than 19 years of experience in Vibrator Design, Development, and Manufacturing.

**ATR PIONEERED IN THE
VIBRATOR FIELD.**

✓ **NEW MODELS** ✓ **NEW DESIGNS**
✓ **NEW LITERATURE**

"A" Battery Eliminator, DC-AC Inverters
Auto Radio Vibrators

See your jobber or write factory

ATR

AMERICAN TELEVISION & RADIO CO.
Quality Products Since 1931
SAINT PAUL 1, MINNESOTA-U. S. A.

NEW PRODUCTS

(continued)

Central Ave., Hillside, N. J. Bulletin 750 describes in four pages an improved line of connectors for solderless splicing and terminating of electrical wires. Illustrated descriptive data, installation instructions and ordering information are given. The pres-Sure tool is pictured in operation.

F-M Equipment. Collins Audio Products Co., Inc., P. O. Box 368, Westfield, N. J. Information on the T-20-A mobile receiver, the S-17-A Storecaster receiver and R-12-A industrial f-m tuner is found in a recent four-page folder. It tells how to increase the earning power of one's f-m station through use of bus radio, store-casting and industrial music. A price list is also available.

Tube-Base Reference. Radio Corp. of America, Harrison, N. J. The Triple Pindex, 2F366R, is a handy quick-reference guide to tube-base diagrams. Over 600 tube types are listed in both alphabetical and numerical sequence. Designed for workbench use, it measures 4 in. x 8 in. Price is 75 cents.

Measurements Notes. Measurements Corp., Boonton, N. J., announce the publication of the second issue of Measurements Notes. The purpose of the four-page brochure is to assist the industry in making measurements of receiver susceptibility to ignition interference.

Recorders and Amplifiers. Sanborn Co., 39 Osborn St., Cambridge 39, Mass. A recent catalog folder contains a loose-leaf-perforated series of bulletins covering a line of direct-writing recorders and instrument amplifiers. Each unit is technically described and illustrated and a price list is included. As other, or newer, models become available, descriptive pages will be sent for inclusion in the folder.

Power Frequency Amplifier. Keithley Instruments, 1507 Warrensville Center Road, Cleveland 21, Ohio. An illustration, chief uses, features and specifications of the model 105 Meter Matcher

Spincraft
SKILL WILL DO IT

offers an approach to the
Production of Electronic Parts that is
fast, simple economical

CONICAL ENVELOPE . . . a stainless steel spinning for cathode ray assembly made of 1/8 in. thick type 446 chrome iron. 16 in. diameter. 11 1/2 in. deep.



RECTANGULAR ENVELOPE . . . a special mass production product made for the television industry of 1/8 in. thick type 430 chrome iron. 24 in. wide. 16 in. high. 9 in. deep.



CORONA SHIELD . . . an aluminum spinning combining hemispherical and spherical forms. Made of 250 aluminum, 1/8 in. thick. Overall length 20 in.

● Immediate cost reduction is today's most urgent demand — requiring more alert thinking in the designing of parts and more ingenious tooling methods. Progressive new Spincraft techniques may help simplify your production problems, just as they have helped other large and small manufacturers.

Some examples of this advanced engineering are shown here. It will pay you to study them . . . and ask yourself if you can use this pioneer company's versatile ability to help solve your electronic problems. You'll find the Spincraft Data Book a good source for ideas. Write for your copy—without obligation.

Spincraft Inc.
SKILL WILL DO IT

4143 W. State St. Milwaukee 8, Wis.
Heretofore known as
Milwaukee Metal Spinning Co.

THIS FEATHERWEIGHT WILL

**LICK
SOLDERING
FATIGUE!**



THE NEW
**HEXA CON
BANTAM**
MODEL 30H

Weight—5½ Ounces • Watts—
40 or 60 • Tip Dia.—Both ⅛" and ¼" Tips
Furnished with Each Iron • Price—\$5.50

So light its weight is hardly noticeable. Out-
performs any iron of equal size. Hatchet de-
sign makes it more comfortable and practical
to use than a pencil iron. No transformer re-
quired. Write for complete catalog.



HEXA CON ELECTRIC CO.
130 WEST CLAY AVE., ROSELLE PARK, N. J.

All-Metal...
All-Weather
MOUNTS

COMPLETE and BALANCED PROTECTION



(CUP TYPE
MODEL #7002)

MET-L-FLEX

Unit mounts and mounting systems with
MET-L-FLEX provide vibration isolation
and true shock absorption through the
widest range of operating conditions.
All-metal • no organic materials
• stable characteristics from -90° C. to
+175° C. • wide load tolerance • built-
in damping for stability and reduced
amplification at resonance.
For electronic or delicate equipment
mounting, write Dept. 505 MET-L-FLEX
Data Sheets available.

ROBINSON AVIATION INC.
TETERBORO, NEW JERSEY
Vibration Control Engineers

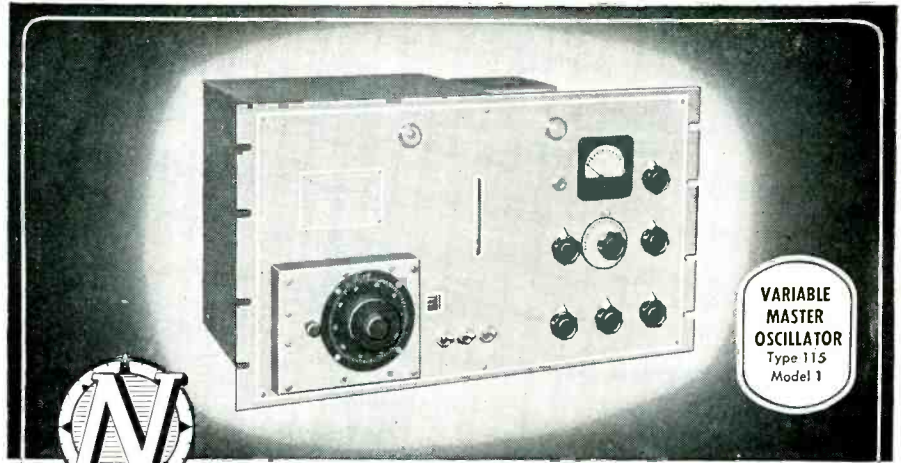

VARIABLE
MASTER
OSCILLATOR
Type 115
Model 1

The Variable Oscillator with CRYSTAL STABILITY

High versatility, plus wide range, plus crystal stability and accuracy—that's the unbeatable combination for the best in diversity reception. You get all three with the Northern Radio VARIABLE MASTER OSCILLATOR. The HFO's stability is ± 20 cps/mc for ambient change of ± 25°C.—matching that of any non-temperature controlled crystal. Its range is 2-32 mc continuous. Crystal check points, with 40 curves supplied, permit absolute frequency setting to ± 25 cps/mc. Three crystal-controlled frequencies provide fixed frequency reception. There's a LF crystal oscillator for BFO.

And, this unit also serves as an excellent transmitter exciter and laboratory measuring standard.

See the specifications on this outstanding model in the 1950 Electronics Buyers Guide. For complete data on the precision-built Northern Radio line, write today for your free latest Catalog E-2.

NORTHERN RADIO COMPANY, inc. : 143-145 West 22nd Street
: New York 11, N. Y.

Pace-Setters in Quality Communication Equipment

**CONTINENTAL CARBOMITE
RESISTORS**



- ★ JAN R-11 Approved
- ★ Ratings, ½, 1 & 2 Watt
- ★ Tolerance 5% & 10%
- ★ Operate at 70° Amb

Ideal for service replacement, especially in television receivers. Available from stock through Continental Jobbers in cooperation with Allen-Bradley.

CONTINENTAL CARBON Inc. CLEVELAND 11, OHIO

For Precision Washers... For Precision Stampings...

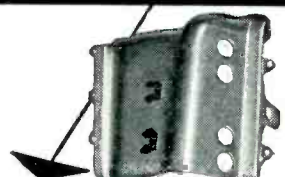
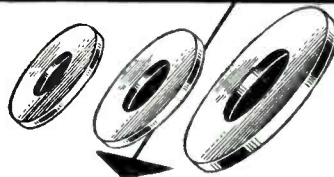

WHITEHEAD STAMPING CO.

A preferred source of precision-made WASHERS and STAMPINGS. 46 years of experience and up-to-the-minute facilities, assure highest quality and service.



EST.
1903

WHITEHEAD STAMPING CO.

1691 W. Lafayette Blvd.

Detroit 16, Michigan

WIDE BAND DIRECT COUPLED OSCILLOSCOPE

Tektronix Type 514-D

Bandwidth: DC—10 mc
Sensitivity: AC—.03 v/cm
 DC—.3 v/cm
Sweep Range: .1 usec/cm—.01 sec/cm
 continuously variable
Voltage Calibrator: Square wave,
 0—50v in 6 ranges

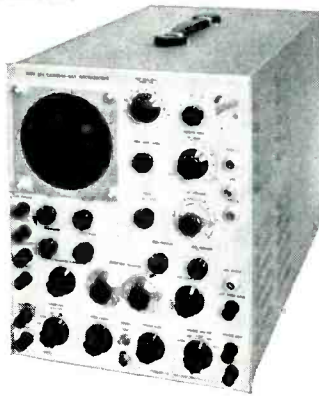

The advantages of the direct coupled oscilloscope are now available in the region of 10 mc. Not only is it possible to measure the duration and amplitude of a waveform, but also the D.C. level at which it occurs.

- Distributed type push-pull output amplifiers.
- All DC voltages electronically regulated.
- Triggered, recurrent or single sweeps.
- .25 μ sec signal delay network.
- Better than 5% accuracy of timing and amplitude.

Write or wire for complete specifications.

\$950.00

f. o. b. Portland,
 Oregon



Circle, TEKTRONIX

712 S. E. HAWTHORNE BLVD. PORTLAND 14, OREGON

may be found in a four-page folder. The unit described is a power frequency amplifier for greatly reducing the errors caused by measuring instrument loading of a circuit under test.

Portable D-C Recorder. Wallace & Tiernan, Belleville, N. J. Publication TP-18-A illustrates and describes a new portable d-c recorder, a direct writing recorder that is adjustable over a wide range. The unit described has a minimum full-scale range of 100 μ a and a maximum full-scale range of 5,000 ma. It is particularly suited for laboratory use.

Antenna Catalog. Jerrold Electronics Corp., 121 N. Broad St., Philadelphia 7, Pa. A 12-page two-color catalog gives full information and shows diagrammatically how a Mul-TV system, including antenna, master control-amplifier unit and distribution outlets, is installed in a typical apartment house or store to provide perfect television reception on any number of television sets connected to the system.

Tube Selection Survey. Industrial Electronics, Inc., 8060 Wheeler St., Detroit 10, Mich., has available a survey form which will be sent to all companies that are interested in obtaining tubes that have superior life characteristics. The superior qualities are obtained by a preaging and selection process.

Resistors. Instrument Resistors Co., 1036 Commerce Ave., Union, N. J. A recent 28-page loose-leaf perforated folder covers a line of application-designed wire-wound resistors. Included are illustrations and specifications on each type.

Artificial Reverberation Generator. Tech Laboratories, Inc., Palisades Park, N. J., has available a single-sheet bulletin treating the type AF101 artificial reverberation generator. Technical specifications given include the unit's input impedance, input and output level, output impedance, controls, reverberation time and power requirements.

MEASUREMENTS CORPORATION MODEL 80 STANDARD SIGNAL GENERATOR



2 to 400 MEGACYCLES

MODULATION: Amplitude modulation is continuously variable from 0 to 30%, indicated by a meter on the panel. An internal 400 or 1000 cycle audio oscillator is provided. Modulation may also be applied from an external source. Pulse modulation may be applied to the oscillator from an external source through a special connector. Pulses of 1 microsecond can be obtained at higher carrier frequencies.

FREQUENCY ACCURACY \pm .5%

OUTPUT VOLTAGE
 0.1 to 100,000
 microvolts

OUTPUT IMPEDANCE
 50 ohms

MANUFACTURERS OF
 Standard Signal Generators
 Pulse Generators
 FM Signal Generators
 Square Wave Generators
 Vacuum Tube Voltmeters
 UHF Radio Noise & Field
 Strength Meters
 Capacity Bridges
 Megohm Meters
 Phase Sequence Indicators
 Television and FM Test
 Equipment

MEASUREMENTS CORPORATION

BOONTON  NEW JERSEY



**For
Advanced
RELAYS
specify
ADVANCE**

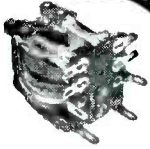

RELAYS for general circuit control, electronic, aircraft and marine applications. Crisp action, dependable and durable. ADVANCE offers sensitive, midget, midget telephone, keying, instrument, time-delay, overload, transmission line, impulse, hermetically sealed, and ceramic insulated relays. Wide variations of these types for special applications and special relays made to specifications.

ADVANCE'S engineering ability and manufacturing facilities will assist in engineering problems and supply special relays for the most exacting requirements. Your inquiry will receive prompt and courteous attention.



ADVANCE ELECTRIC & RELAY CO.
2435 North Naomi Street ★ Burbank, California

**A fastener AIN'T, if—
it works loose.**

**The "FLEXLOC" IS—
because it won't!**

FLEXLOC

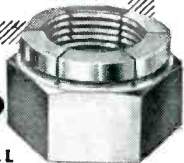

**ONE-PIECE, ALL-METAL
STOP- and LOCK-NUT**

Its "chuck-like", resilient locking segments lock the "FLEXLOC" securely in any position on a threaded member with a controlled, uniform and dependable torque.

Tough applications demonstrate that the "FLEXLOC" positively "won't work loose", yet it can be removed easily with a wrench when desired. Because it is all-metal, temperatures as high as 550°F. hold no terrors for the "FLEXLOC".

The "FLEXLOC" has plenty of tensile . . . can be re-used many times . . . has therefore a long, effective life.

Write for further information and free samples.

See us at Booth 2434, Convention of National Metal Congress and Exposition, Chicago, October 23 to 27.

STANDARD PRESSED STEEL CO.

JENKINTOWN 10, PENNSYLVANIA

MASS PRODUCTION FABRICATED SHEET METAL PRODUCTS YOUR OWN OR GOVERNMENT SPECIFICATIONS

COMPLETE facilities under one roof for quality mass production—including welding, baking and finishing. Whistler and Wiedermann equipment for short runs. Tool and die engineering and designing. Completely conveyerized finishing facilities.

Large assortment of stock and special dies for the radio, television and electronic field. Production and engineering under the direction of a competent executive who has had over 36 years experience in sheet metal fabrication backed up by a substantial organization and personnel.

Chassis	Instrument Housings
Enclosures	Panels—Boxes
Metal Cabinets	Sample Models
Consoles	Water Tight Boxes
Spare Part Boxes to Army-Navy Specifications	

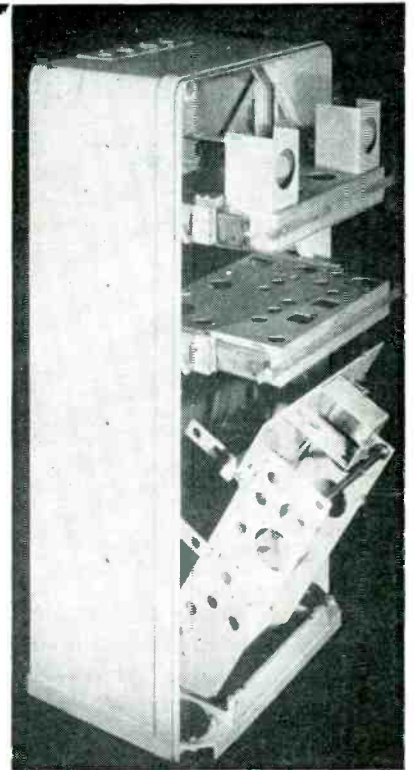

Send your blueprints and requests for prompt attention and quotations.

ART-LLOYD METAL PRODUCTS CORP.
2973 Cropsy Avenue
Brooklyn 14, N. Y.

Telephone: ESplanade 3-2400-1

Precision **MINIATURE** **SLIPRING** Assemblies

and commutators for gyros,
computers, resolvers, motors, selsyns

- Absolute minimum torque friction.
- Diameter ranges .050" — 24.0"
- Minimum 1000 V.A.C. hi-pot between circuits.
- Hard silver plated to plastic base and wire to form rigid assembly that withstands up to 12,000 r.p.m.
- Supplied to your specifications at competitive prices.

ELECTROTEC Corporation

53 BERGEN TURNPIKE

LITTLE FERRY, N. J.

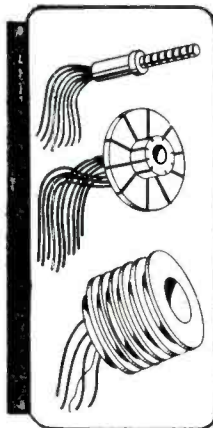

**DANO coils
stop Production
Holdups!**

For uninterrupted production demand Dano trouble-free coils made up to your exact specifications. Avoid production holdups! Order now from Dano, makers of a wide variety of coils.

Also, Transformers Made To Order

- Form Wound
- Paper Section
- Acetate Bobbin
- Molded Coils
- Bakelite Bobbin
- Cotton Interweave
- Coils for High Temperature Applications



THE DANO ELECTRIC CO.
MAIN ST., WINSTED, CONN.

THE HI-GAIN Industrial POCKETSCOPE

BY WATERMAN

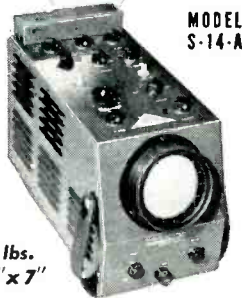

MODEL S-14-A

Wt. 12 3/4 lbs.
12" x 5 1/4" x 7"

Another Waterman **POCKETSCOPE** providing the optimum in oscilloscope flexibility for analyses of low-level electrical impulses. Identified by its hi-sensitivity and incredible portability, S-14-A **POCKETSCOPE** now permits "on-the-spot" control, calibration and investigation of industrial electronic, medical and communications equipment. Direct coupling without peaking, used in the identical vertical and horizontal amplifiers, eliminates undesirable phase shifting. Designed for the engineer and constructed for rough handling, the HI-GAIN **POCKETSCOPE** serves as an invaluable precision tool for its owner.

Vertical and horizontal channels: 10mv rms./inch, with response within -2DB from DC to 200KC and pulse rise of 1.8μs. Non-frequency discriminating attenuators and gain controls with internal calibration of trace amplitude. Repetitive or trigger time base, with linearization from 1/2cps to 50KC with ± sync. or trigger. Trace expansion. Filter graph screen. Mu metal shield. And a host of other features.

WATERMAN PRODUCTS CO., INC.

PHILADELPHIA 25, PA.
CABLE ADDRESS: POCKETSCOPE

WATERMAN PRODUCTS INCLUDE:

S-10-B GENERAL **POCKETSCOPE**
S-11-A INDUSTRIAL **POCKETSCOPE**
S-14-B WIDE-BAND **POCKETSCOPE**
S-15-A TWIN TUBE **POCKETSCOPE**
S-21-A LINEAR TIME BASE

Also **RAKSCOPES, LINEAR AMPLIFIERS, RAYONIC® TUBES** and other equipment



NEWS OF THE INDUSTRY

(continued from page 130)

tivity. With the Aid of the Noise Diode, by W. K. Squires of Sylvania Electric Products Inc.

2:00 P.M.—Quality Control Session (J. R. Steen, presiding)
Application of Statistical Quality Control in Manufacture of Electronic Products, by E. R. Ott of Rutgers U. and G. Scheel of Sonotone Corp.

The Quality Control Indicator, by C. J. Falk of General Electric Co.

The Control of Averages in Radio Tube Manufacture, by A. K. Wright of Tung-Sol Lamp Works, Inc.

The Human Aspect of Engineering Quality into the Product, by C. Gartner of Allen B. DuMont Labs., Inc.

8:00 P.M.—Joint Session with Technology Club of Syracuse

Tues. Oct. 31

9:00 A.M.—Television Session (R. A. Hackbusch, presiding)

A Study of Permanent Magnet Focusing Devices for Television Picture Tubes, by K. James and R. T. Cappodanno of Emerson Radio & Phonograph Corp.

The Application of a New Low-Noise Double Triode as an RF and IF Amplifier in Television Receivers, by R. M. Cohen of RCA.

Consideration of Optimum Use of Picture Tubes, by W. B. Whalley of Sylvania Electric Products Inc.

Evaluation of Performance Characteristics of Cathode-Ray Tubes for Use in Television Receivers, by K. A. Hoagland of Allen B. DuMont Labs., Inc.

2:00 P.M.—Television Session (D. D. Israel, presiding)

The Technical Aspects of Phonovision, by E. M. Roschke of Zenith Radio Corp.

An Analysis of Color Television, by A. V. Loughren of Hazeltine Electronics Corp.

Wed. Nov. 1

9:00 A.M.—Audio Session (O. L. Angevine, Jr., presiding)

The Mechanics of the Phonograph Pickup, by T. E. Lynch of Brush Development Co.

Lightweight Pickup and Tone Arm, by C. R. Johnson and L. J. Anderson of RCA.

Sound Pickup in High Ambient Noise, by W. Beaverson of Electro-Voice Inc.

Radiotelephone Third

A NEW CLASS of license has been established to meet a need for non-technical radiotelephone operation intermediate between the telephone second and the restricted radiotelephone operator permit. The latter is issued to those at certain stations employing pushbutton equipment. Among the stations that can be operated by the new class of license are noncommercial educational broadcast stations with 10 watts of power or less.

Supplement No. 6 to the FCC Study Guide has been issued for those preparing for the new examination. A new study guide, last revised in July 1948, will be available by January 1951. This booklet will bring all the examination elements up to date and include a new Element 8 covering ship radar techniques.

New Bureau

THE NEW Safety and Special Radio Services Bureau recently estab-

how can
**YOU use this
unique Edison
Thermal Relay?**

- For cathode protection
- — overload protection
- — holdovers
- — pulse integration
- — motor starting
- — or other control functions?

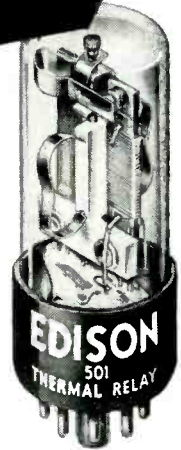

If you are designing circuits requiring a time delay element, or a reliable relay where a short operating interval can be tolerated, it might be to your advantage to consider the Edison 501 Thermal Relay.

Here are 7 good reasons why:

1. **Vibration and shock resistant**—Guaranteed to withstand continuous vibration of 1/16" over-all amplitude at 55 cps., and impact shock of 50 g.
2. **Chatter-proof**—Pre-loaded spring provides 50-gram pressure almost instantaneously, for sure, positive operation.
3. **Non-position sensitive**—Characteristics not affected by mounting angle—operates satisfactorily in any position. Standard intermediate octal base.
4. **Ambient compensated**—Automatically compensated for ±60° C. ambient range by extra unheated bimetal. Will operate from -60° C. to +100° C.
5. **Non-arc-ing**—Sealed-in-glass. Operates in its own arc-suppressing atmosphere. Withstands substantial currents and voltages without arc-pitting.
6. **Explosion-proof**—Hermetically sealed. You can specify it for safe use in corrosive or hazardous fumes and dusts. Tamper-proof, too.
7. **Fungus-resistant**—Available with fungus and salt-spray resistant micanol base.

GENERAL SPECIFICATIONS—STANDARD TYPES

Operating Time—5 to 300 sec., in 14 standard intervals, pre-set at factory.	Heater—5 watts, 117 v, 26.5 v, 6.3 v, dc. or ac to 2400 cps
Contacts—Silver, SPST, normally open.	Size—1.275" max. dia., 3.250" max. sealed height, standard 1.9 envelope
Contact Rating—Types 5 sec. to 75 sec., 3 amp, 150 vdc or 250 vac; Types 90 to 300 sec. 3 amp, 450 v, ac/dc.	Weight—1", to 2", ounces.
Other than standard types can be made up on special order to meet requirements for other heater voltages, higher currents, etc.	

LITERATURE AVAILABLE

Free illustrated Bulletin 3007A gives full details. Write today for a copy, 296 Lakeside Ave., West Orange, N. J.



**PRECISION MINIATURE
6" DRILL PRESS WITH-
SENSITIVE FEEL!**

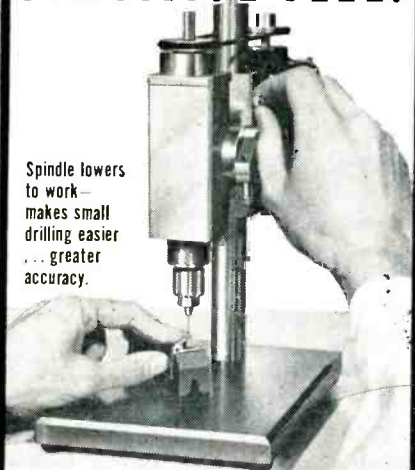

Spindle lowers to work—makes small drilling easier... greater accuracy.

MODEL 204-B meets the increasing post-war demand for small drilling to ever higher accuracy standards. Spindle turns smoothly on Selected Bearings; run out less than .0004"; table square to spindle within .0006" at 2½" radius. Permanent accuracy; castings annealed and ground. Write Bulletin E-1.



Phillips & Hiss Co., Inc.

6666 Lexington Avenue
Hollywood 38, California

**ELECTRONICALLY REGULATED
LABORATORY
POWER SUPPLIES**



**BENCH
MODEL 25**

• STABLE
• DEPENDABLE
• MODERATELY PRICED

- **INPUT:** 105 to 125 VAC, 50-60 cy
- **OUTPUT #1:** 200 to 325 Volts DC at 100 ma regulated
- **OUTPUT #2:** 6.3 Volts AC CT at 3A unregulated
- **RIPPLE OUTPUT:** Less than 10 millivolts rms

For Complete information write for Bulletin E

WIDTH 14"
DEPTH 6"
HEIGHT 8"
WT: 17 LBS.



**LAMBDA ELECTRONICS
CORPORATION
CORONA NEW YORK**

**NOW!
ACME-MOLD COILS**

*Better than ever when molded
and impregnated with the*

*New! ACME STAR
COMPOUND*

A PRACTICALLY 100% SOLIDS THERMOSETTING RESIN!

- Added toughness and abrasion resistance.
- Greatly increased resistance to moisture and humidity.
- Flame resistance.
- Perfect "moldability".
- Higher dielectric strength.
- Lower power losses.

Acme Wire

THE ACME WIRE CO.

NEW HAVEN, CONN.

INSULATING VARNISHES
ACME-MOLD COILS

MAGNET WIRE
VARNISHED INSULATIONS

Little-thought-of facts about capacitors

The short time breakdown voltage of a well-made D.C. capacitor is not less than 5 to 6 times the actual working voltage at 20°—

$$E = 5 \times e \text{ min}$$

E = Breakdown voltage
e = Rated d.c. working voltage

INDUSTRIAL CAPACITORS are unvaryingly held to this formula.

Designed for maximum safety and the smallest possible volume, INDUSTRIAL CAPACITORS are the most widely used capacitor in industrial applications.

WRITE TODAY FOR DETAILED CATALOG

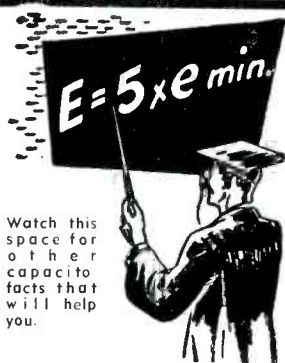

Watch this space for other capacitor facts that will help you.

Sales Offices in
All Principal Cities
3243 N. California Ave.
Chicago 18, Illinois

INDUSTRIAL CONDENSER CORP.

WHAT MAKES A MAILING CLICK?



**McGraw-Hill
DIRECT MAIL LIST SERVICE**

Advertising men agree... the list is more than half the story. McGraw-Hill Mailing Lists, used by leading manufacturers and industrial service organizations, direct your advertising and sales promotional efforts to key purchasing power.

In view of present day difficulties in maintaining your own mailing lists, this efficient personalized service is particularly important in securing the comprehensive market coverage you need and want. Investigate today.

McGraw-Hill Publishing Co., Inc.
DIRECT MAIL DIVISION

330 West 42nd Street New York 18, New York

NOTHELPER

Special TRANSFORMERS

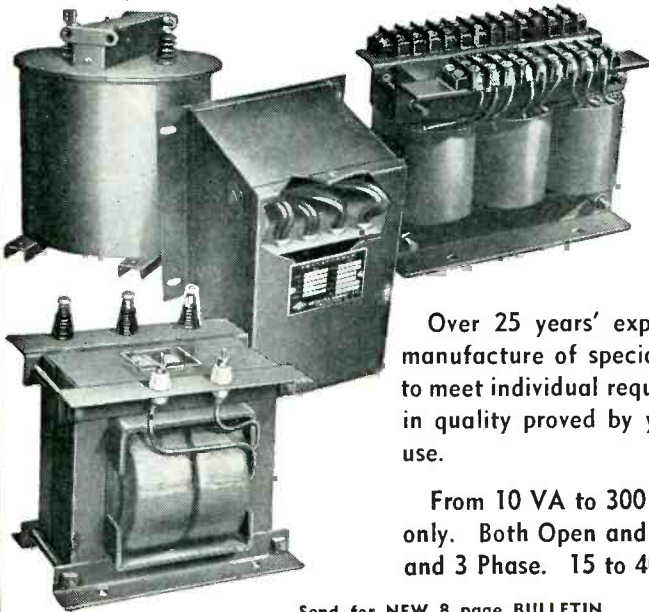

Proven by
Past
Performance

Over 25 years' experience in the manufacture of special transformers to meet individual requirements. Built in quality proved by years of actual use.

From 10 VA to 300 KVA Dry-Type only. Both Open and Encased. 1, 2, and 3 Phase. 15 to 400 cycles.

Send for NEW 8 page BULLETIN

NOTHELPER
WINDING LABORATORIES

9 ALBEMARLE AVE., TRENTON 3, N. J.



lished by FCC is headed by Edwin L. White, Chief. He is charged with the unification of regulations for nonbroadcast, certain common carrier (including aeronautical) radio, ship and public coastal, public safety, amateur, land transportation, industrial and citizens radio services. His assistant is Lester W. Spillane.

Heading up the five divisions are: Marine, William N. Krebs; Aviation, John R. Evans; State-Local Government and Amateur, George K. Rollins; Industry and Commerce, Glen E. Nielsen; Authorization Analysis, Charles R. Weeks. The chief of the Enforcement unit is Marshall S. Orr.

Citizens Radio

FCC HAS AMENDED its rules for the Citizens Radio Service to permit operation of such stations by any person so authorized by the station licensee as long as communication does not involve transmission of Morse code telegraphy.

BUSINESS NEWS

JOHN MECK INDUSTRIES, INC., tv receiver manufacturer, is now operating a new building providing 20,000 sq ft of additional production space at its main Plymouth, Ind., factory.

GOULD-NATIONAL BATTERIES, INC., recently became the new name of the National Battery Co., manufacturer of industrial storage batteries, when the stockholders of the latter firm approved the change proposed by the board of directors.

GENERAL ELECTRIC Co., Syracuse, N. Y., has bought the Illinois Cabinet Co. at Rockford, Ill., which will continue to produce its present line of wood products for tv home receivers.

PRODUCTION EQUIPMENT Co., 37 W. Main St., Oyster Bay, N. Y., is now functioning as two separate organizations. Production Tool & Fixture Co. will continue with the sub-contract portion of the business producing aircraft and similar parts. Coil Winding Equipment



The *Berkeley*
MODEL 410
INDUSTRIAL
COUNTER

★ **HIGH SPEED COUNTING**—Any mechanical, electrical or optical events that can be converted to changing electrical voltages can be counted at rates up to 10,000 per second.

★ **DIRECT READING**—no interpolation necessary; capacity of 1,000,000,000 counts.

★ **VERSATILE**—easily adapted for precise revolution counting,

linear measurements, frequency measurement, RF interpolation, nuclear counting, as well as virtually all laboratory and industrial high speed counting applications.

★

Complete description and specifications are yours for the asking.

Please request Bulletin PI-410.

Berkeley Scientific Company

SIXTH & NEVIN AVENUE • RICHMOND, CALIFORNIA

MICO ENGRAVER

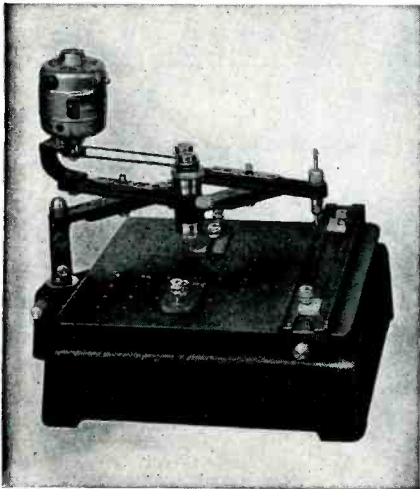

FEATURES

1. Ball Bearing Micrometer spindle for absolute control of depth of cutter in all four ratios.
2. Accuracy of reproduction in four ratios due to excellent precision machining of pantograph arms.
3. Absolute accuracy in three-dimensional duplicating.
4. Many attachments available to increase versatility, such as extension arm, rapid self-centering vise, extension post for pantograph and copy carrier, hand engraving spindle and many more.
5. Copy and work right-side up and in view of operator.

Catalog on Request

MICO INSTRUMENT CO.
76E Trowbridge St. Cambridge 38, Mass.

electronics

PUBLISHES

13

ISSUES YEARLY

including the

MID-JUNE

BUYERS' GUIDE

*Condensed!!
Power*

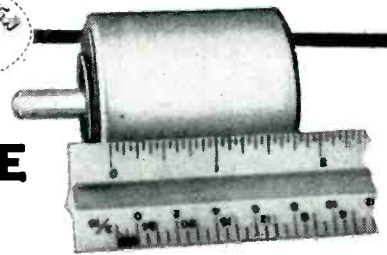

NEW 400 CYCLE MINIATURE

(INDUCTION)

MOTOR

PERFORMANCE CHARACTERISTICS

Horsepower	1/50 HP
Voltage	200 Volts
Current	0.25 Amps.
Phase	3 Phase
Speed	10,000 RPM
Frequency	400 Cycles
Weight	10 oz.
Overall Dimensions	1 3/4" dia. x 1 7/8"

- Maximum HP
- Minimum Size
- Minimum Weight
- Meets "JAN" specs.
- Reversible
- Totally Enclosed
- Wide Ambient Temp. Range

- Long Life
- Dependability

ANOTHER EAD FIRST! This unit provides the highest possible HORSEPOWER OUTPUT PER UNIT WEIGHT AND VOLUME and is most valuable for use in aircraft applications and devices in confined areas.

For further details write to Department "B."

EASTERN AIR DEVICES, INC. 585 DEAN STREET
BROOKLYN 17, N. Y.

MOVING?

If you are moving (or have moved), tell us about it, won't you? Your monthly copies of ELECTRONICS will not follow you unless we have your new address immediately. Make sure you don't miss a single important issue . . . and help us make the correction as speedily as possible by giving us your old address, too

ELECTRONICS

CIRCULATION DEPT.

330 W. 42nd St.

New York 18, N. Y.

PFANSTIEHL PICKUP IS TO OTHER PICKUPS
as **FM RADIO IS TO AM RADIO**

The difference between the quality of music obtainable from the new PFANSTIEHL STRAIN-SENSITIVE PICKUP and that from ordinary pickups is as great as the difference between good FM radio and AM radio reception.

There are good reasons why the PFANSTIEHL STRAIN-SENSITIVE PICKUP brings out the brilliance of truly great voices and orchestras... the latent music on your records that other methods of reproduction leave untouched.

- The PFANSTIEHL STRAIN-SENSITIVE PICKUP is an amplitude transducer with a CONSTANT RESISTANCE of about 250,000 ohms.
- Signal output is at a practically CONSTANT IMPEDANCE level.
- Excellent transient response.
- NO DISTORTION, phase shift or evidence of intermodulation apparent.
- LINEAR RESPONSE free from peaks or resonances.



ELEMENT (enlarged)



CARTRIDGE

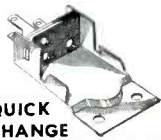

QUICK CHANGE CARTRIDGE HOLDER

Cartridges for micro groove (.001 tip radius) and standard groove (.0027 tip radius) are available along with a Quick Change Cartridge Holder.

Styli are tipped with famous PFANSTIEHL M47B Precious Metal Alloy which will wear to less than a .003 flat in 100 plays on standard records at proper stylus pressure. Strain-Sensitive Elements equipped with Diamond styli are also available.

A special preamplifying circuit is necessary for operation of this new pickup. Four styles of preamplifiers with and without power supply and continuous tone controls are available, and are engineered to provide the correct polarized current for the pickup element, and also to provide the first stages of signal gain.

Proof of the excellence of the PFANSTIEHL STRAIN-SENSITIVE PICKUP is apparent both in tests and in actual listening, when its wide range flat response is best demonstrated. Ask your radio supply man or use the handy coupon below to get complete FREE INFORMATION.

P F A N S T I E H L
CHEMICAL COMPANY
 (Metallurgical Division)
 104 Lake View Avenue • Waukegan, Illinois

Pfanstiehl Chemical Company (Metallurgical Division)
 104 Lake View Avenue, Waukegan, Illinois

Send me complete free information about the new PFANSTIEHL STRAIN-SENSITIVE PICKUP.

Name.....
 Address.....
 City, Zone & State.....
 My Radio Supply House is.....
 Address.....

Co. will continue with the design and manufacture of equipment for the coil-winding industry.

TETRAD CO., INC., 4921 Exposition Blvd., Los Angeles 16, Calif., is a recent entrant into the electronic components manufacturing field. It will specialize in the manufacture of miniature solenoid coils.

FIELDEN INSTRUMENT CORP., industrial control manufacturer, announces the occupation of new and larger office and factory space at 2920 North 4th St., Philadelphia 33, Pa. The name of the company has been changed from Fielden Electronics Inc.

GENERAL ELECTRIC Co., recently announced a three-million dollar expansion program for its receiving tube plants at Owensboro, Ky., and Tell City, Ind., involving the addition of 134,000 sq ft of floor space and new tube making equipment.

BETA ELECTRIC CORP. has moved to new and larger quarters at 333 E. 103 St., New York 29, N. Y. The new premises will allow about five times as much production area as was formerly available and will allow for the manufacture of power supplies up to 400 kv.

LEAR, INC. has acquired the balance of 9,600 sq ft of space in its main building in Grand Rapids, Mich., increasing the main plant area to 180,600 sq ft. The added space will be used to further increase production of such devices as automatic controls, servomechanisms, aircraft radio and other aircraft accessories.

ELECTRONCRAFT CORP. has been formed at Lakewood, Ohio, to manufacture electronic equipment under contract. Theodore C. Asad, 1578 Ridgewood Ave., is president of the firm.

NATIONAL BUREAU OF STANDARDS, Washington 25, D. C., recently established the Office of Basic Instrumentation, to coordinate a program of evaluation and improvement of instruments for measuring basic physical quantities.

ATOMIC INSTRUMENT Co., manufacturers of nuclear research equip-

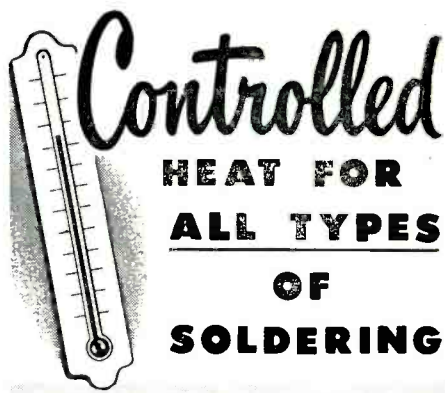

Controlled HEAT FOR ALL TYPES OF SOLDERING

With 250-Watt WELLER GUN

No need to change tools for light or heavy soldering. The 250-watt Weller Soldering Gun does both with controlled dual heat. 5-second heating saves time and current on every job. Your Weller Gun pays for itself in a few months.

Check These Time-and-Money Saving Features



- TRIGGER-SWITCH CONTROL**—Governs heat for light or heavy work. Saves power because no need to unplug gun between jobs.
- SOLDERLITE**—Spotlights the work. Lets you see what you're doing at all times.
- 5-SECOND HEATING**—No waiting, no wasted current. Saves hours and dollars each month.
- LONGER REACH**—Lets you get at any job with ease. Slides between wiring—into the tightest spots.
- STREAMLINED**—Compact and comfortable to hold. Pistol-balanced for fast precision soldering.
- RIGID-TIP**—Chisel-shaped. More soldering area for faster heat transfer. "Over-and-under" terminals give bracing action.
- DUAL HEAT**—Single heat 200 watts; dual heat 200/250 watts; 120 volts, 60 cycles.

See the new 250-watt Weller Soldering Gun today at your distributor—or write for bulletin direct.

SOLDERING GUIDE—Get your new copy of SOLDERING TIPS—revised, up-to-date and fully illustrated 20-page booklet of practical soldering suggestions. Price 10c at your distributor, or order direct.



WELLER
ELECTRIC CORP.

806 Packer Street, Easton, Pa.

ment, have moved to new, larger, and more conveniently located quarters at 84 Massachusetts Ave., Cambridge 39, Mass.

THE FIDELITY TUBE CORP. (formerly the Allied Video Corp.) has acquired 80,000 sq ft of space at 1000 Passaic Ave., East Newark, N. J., and has set up to make tv picture tubes. Full production goal is 1,800 per day.

PERSONNEL

WALTER F. KRAM, formerly engaged in CAA omnidirectional range development work at Lavoie Laboratories, has joined the staff of Ballantine Laboratories, Inc., Boonton, N. J., as a senior engineer.

GEORGE D. HULST, at one time engaged in development work on the proximity fuse, and until recently in the General Patent Department of the Research Division of Allen B. Du Mont Laboratories, Inc., has been promoted to manager of the Special Projects Laboratory of the Electronic Parts Division.

WILLIAM J. MORLOCK has been promoted to assistant manager of the Commercial Equipment Division of the General Electric Co., Syracuse, N. Y.



W. J. Morlock

R. M. Daugherty

ROGER M. DAUGHERTY, previously associated with Colonial Radio Division of the Sylvania Electric Products Corp. as manager of government sales and engineering and chief engineer, has been elected executive vice-president of J. H. Bunnell & Co., Brooklyn, N. Y., manufacturers of railroad and radio communication equipment.

RALPH R. BATCHER, New York electronic consultant, recently succeeded L. C. F. Horle as chief engineer of the engineering department of the RTMA and manager of the

Try Remler for Service-Tested "Hard-to-Get" Components



TYPE 50
4-pin socket

TYPE 56
octal socket

Custom Components

Metal-plastic components designed and manufactured to order. Write for quotations specifying electrical and mechanical characteristics. Describe application. No obligation.

REMLER TUBE SOCKETS

● STANDARD FOR 30 YEARS...
THE BEST IN THE INDUSTRY

Heavy duty phenolic sockets with high current wiping action contacts... for industrial, transmitter and test applications. Rugged. Years of tube insertions and withdrawals do not impair contact effectiveness. Black phenolic is standard, low loss phenolic or alkyd on order.

Remler Company Ltd. 2101 Bryant St. San Francisco 10, Calif.

Remler

Since 1918 PIONEERS IN ELECTRONICS AND PLASTICS

make your own Plug-In

RELAYS
COILS
FILTERS

with DESCO Plug-In Assemblies
as basic housings

LEFT—Self-Locking Relay, used for Motor Controls. Automatic Electric Mfg. Co.—
DESCO 'DG' 106 ASSEMBLY

CENTER—Discriminator Coil, used in low-frequency receiver by Harmon Electronics Co.—
DESCO 'DL' 151 ASSEMBLY

RIGHT—Toroidal Filter. Manufactured by Communications Accessories Co.—
DESCO 'DG' 109 ASSEMBLY

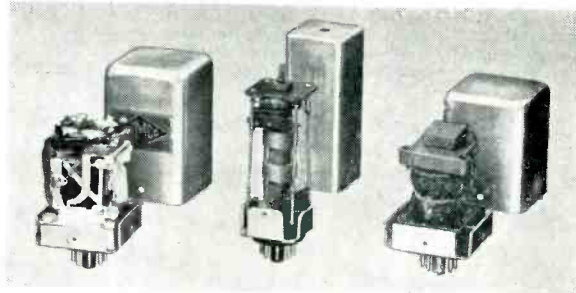

We Can Furnish Units With Coils Wound To Your Specifications



The DESCO Plug-In Assembly—a fitted aluminum shield can with octal-type plug connector in base. Available with and without coil forms or adjustable powdered iron tuning cores.
30 MODELS—1 3/8" and 2" square—2" to 4" high.

Write for Literature and Specifications.

DIETZ DESIGN & MANUFACTURING COMPANY
Inductance Specialists
Grandview, Missouri Dwight 7216

RADIO SHACK 1951 CATALOG JUST ISSUED!

WRITE TODAY for your FREE copy of the giant new 172-page Radio Shack Catalog — America's most complete, lowest-price electronics line. Latest post-Korean war releases of new equipment. One of the few all-new catalogs that will appear this year!

The RADIO SHACK Corp.

167 WASHINGTON ST., BOSTON, MASS.

RADIO SHACK

PRESENTS



THE

AMPEX

NEW MODEL "400"

MAGNETIC TAPE RECORDER

15 kc at 7 1/2 ips
15 and 7 1/2 speeds'
66 minutes at 7 1/2
Half or full tracks
Fully portable!

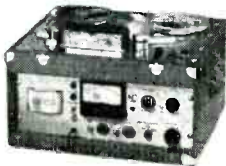

The brilliant new Ampex "400" features a 30-15,000 cycle response at 7 1/2", established a new high in fidelity at that speed and in its price range. Complete in ONE portable case. Complete plug-in head housing and other Ampex exclusives! Only \$750.00. Write for details!



Get FREE BOOKLET today!

Radio Shack BOSTON 8, MASS.

Without obligation please send 16-page illustrated booklet containing technical specifications of Ampex Magnetic Tape Recorders.

NAME _____

ADDRESS _____

CITY _____

STATE _____

Our need is for:

- Laboratory Research
 Multi-Channel Recording
 Recording-Broadcasting

- Telemetering
 Industrial Recording
 Aerophysical Research

The RADIO SHACK Corp.

167 WASHINGTON ST., BOSTON, MASS.

NEWS OF THE INDUSTRY

(continued)

RTMA Data Bureau, New York City.

V. K. ZWORYKIN, Director of Electronic Research, RCA Laboratories Div., Princeton, N. J. was awarded the 1951 Medal of Honor by IRE.

ROBERT G. SCOTT, senior engineer for Allen B. Du Mont Laboratories, Inc., has been named head of the company's Commercial Engineering Department.

DUNDAS P. TUCKER, former director of electronics design and development for the Navy's Bureau of Ships, is the new director of the Naval Electronics Laboratory at Point Loma, San Diego, Calif.

J. GRAYSON JONES, former chief engineer of Conrac, Inc., Glendora, Calif., tv receiver manufacturers, has been elected vice-president of the company.

J. A. HUTCHESON, director of research at Westinghouse Electric Corp., Pittsburgh, Pa., has been named chairman of the Committee on Ordnance, Research and Development Board.

ARTHUR GREEN, formerly vice-president and chief engineer of Thomas Electronics Inc., Passaic, N. J., is now vice-president and chief engineer of the new Fidelity Tube Corp., East Newark, N. J., tv picture tube manufacturers.

DAVID B. SMITH, vice-president of Philco Corp., has been named vice-director of the RTMA engineering department.

B. V. K. FRENCH has joined Allen B. DuMont Labs., Inc., East Paterson, N. J., as application engineer in the Electronic Parts Division.

E. H. ULM, previously with Western Electric Co. as field engineer, and until recently sales engineer for the Electronics Division, Sylvania Electric Products Inc., has been appointed Sylvania's merchandising manager.

HARALD SCHUTZ, formerly electronics research specialist and consultant on microwave problems, now heads radio-frequency engineering in the electronics department of The Glenn L. Martin Co.

SELENIUM RECTIFIERS

MINIATURE TYPE

65 to 1,000 ma.
To 160 v. R.M.S.

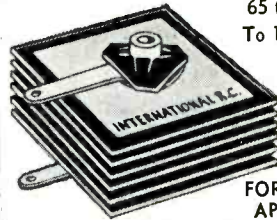

In half wave or doubler circuits.

FOR ELECTRONIC APPLICATIONS.

Ask for Bulletins IS-1249, RN-949

HIGH VOLTAGE TYPE



RATINGS TO 100 KV.
1 to 75 ma.

In Phenolic, Glass or Hermetically Sealed Assemblies.

POWER TYPE

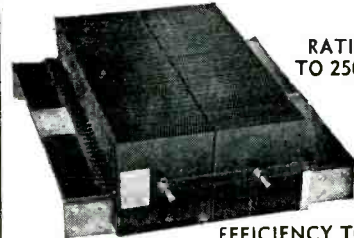

RATINGS TO 250 KW.

EFFICIENCY TO 87%

Ask for Bulletins C-349, C-848.

YOUR INQUIRY IS INVITED

INTERNATIONAL RECTIFIER CORP.

6809 S. Victoria Ave.
LOS ANGELES 43, CALIFORNIA

... highest known
Recording Efficiency
for Instrumentation Applications

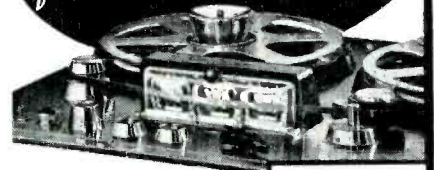

Ampex Magnetic Tape Recorders offer the only proved means of making electrically reproducible recordings up to 40,000 cps! Such critical recording permits detailed study of particular phenomena from tape loops, or other automatic data reducing systems. Up to 14 channels of data recorded simultaneously on separate tracks where required. Special systems record down to 0 cycles with no phase shift or wave form distortion. Write for analysis of your specific problem.



Ampex Magnetic Tape Recorders are available in console, rack or portable types.

UNLIMITED USES INCLUDE:

- Recording-Broadcasting
- Aerophysical Research
- Industrial Recording
- Multi-Channel Recording
- Laboratory Research
- Portable Half-Track Recording
- Telemetering

STANDARD OF THE GREAT RADIO SHOWS
AMPEX
MAGNETIC TAPE RECORDERS

AMPEX ELECTRIC CORP.
San Carlos, Calif.

CONTACTS

FOR THE FIELD OF ELECTRONICS



THE NON-MELTING SILICONE INSULATING AND WATERPROOFING COMPOUND FOR IGNITION SYSTEMS AND ELECTRONIC EQUIPMENT.

MEETS ALL REQUIREMENTS OF AN-C-128a.

STABLE AT TEMPERATURES FROM -70° to +400°F.

For more data on DC 4 Silicone compound write Dept. J

Dow Corning
FIRST IN SILICONES

DOW CORNING CORPORATION
MIDLAND, MICHIGAN
Atlanta • Chicago • Cleveland • Dallas
Los Angeles • New York
Canada: Fiberglas Canada, Ltd., Toronto
Great Britain: Albright and Wilson, Ltd., London



FINE RIBBONS OF TUNGSTEN and Molybdenum

Quality and accuracy in our fabrication of Tungsten & Molybdenum Ribbons have characterized our service to the Electronic industry.

A development of
H. CROSS Co.
5 Beekman St., New York 7, N. Y.

CEMENTS FOR THE RADIO INDUSTRY

NITROCELLULOSE SYNTHETIC
MOISTURE RESISTANT
THERMO PLASTIC
THERMO SETTING
VINYL IN COLOR
COIL VARNISH

BARRETT VARNISH CO.
1532 South 50th Court
Cicero 50, Ill.

Write Us for Additional Information

YOU NEED THIS BOOK

1951 Edition

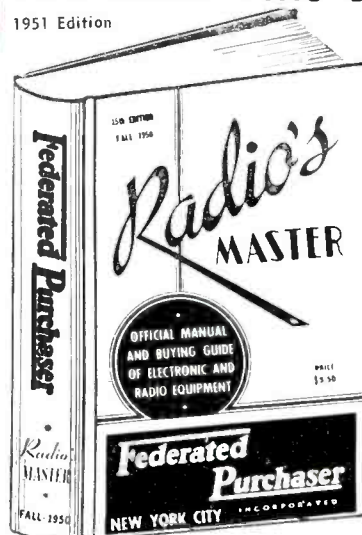

Over 1200 pages

The only source book listing 90% of all electronic products, cross index. Hard Cover

Price only \$1.65 A Give-Away
Price credited on first purchase
Save time & money—Order NOW



CABLE: FEDERPURCH
INCORPORATED
66 DEY ST., NEW YORK 7, N. Y.
Dial 9-3050

Newark, N. J. Allentown, Pa. Easton, Pa.

SUB-MINIATURE PRINTED ELECTRONIC CIRCUITS

produced from your schematics or existing electronic equipment. Circuits fired on ceramics or air dried on plastics and paper bases. Confidential service.

PLASTICS & ELECTRONICS CO.
272 Northland Ave., Buffalo 8, New York

A EUROPEAN SOURCE OF SUPPLY INVITES YOUR ENQUIRIES FOR TELEVISION & RADIO PARTS

FLUORESCENT LAMPS & ACCESSORIES

Societe Industrielle ALFA
80, rue de la Senne, Brussels-Belgium
Cables: RALFA-BRUSSELS

Manufacturers and Exporters of World-Wide Reputation



FLUXES
SODERING
BRAZING & WELDING

L. B. ALLEN CO. INC. Chicago 31, Ill.
6751 Bryn Mawr Ave.

high speed high sensitivity

SHORTED TURN INDICATOR

The Kartron Shorted Turn and Open Circuit Coil Checker — Model 101B — indicates single shorted turns of #44 wire in unmounted coils. Standard mandrel 3/16 x 1/4 for all average size coils. Regulated vacuum tube circuit. Jack for audio indication to supplement i-ma. meter. Prompt deliveries. Price \$150.

KARTRON Huntington Beach, Calif.



EISLER Manufactures Complete Equipment for:

SPOT WELDERS, Electric, for 1/4 to 250 KVA.
TELEVISION TUBE GLASS WORKING EQUIPMENT.
TRANSFORMERS, Special and Standard Types.
INCANDESCENT LAMP Manufacturing Equipment.
FLUORESCENT TUBE Manufacturing Equipment.
NEON SIGN MAKERS EQUIPMENT.
ELECTRONIC EQUIPMENT Vacuum Pumps, etc.
WET GLASS SLICING and Cutting machines for Laboratory use.

EISLER ENGINEERING CO., Inc. 751 So. 13th St., Newark 3, N. J.

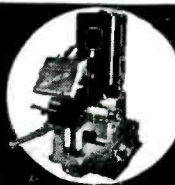

EL-TRONICS, INC.

Research, development, and manufacture of electronic equipment—a single model to large quantities.

Write Today for Free Resume of Our Plant Facilities
Specialists in Geiger-Muller equipment
2647-67 N. Howard St.-Phila. 33, Pa.-GARfield 5-2026



GRC WING NUTS

TOP QUALITY PRICED LOWER

Rust-proof zinc alloy with GRC's recessed-wing finger-grip. All commercial finishes, all popular thread sizes. Special threads or untapped wing nuts: special designs to order.

Write today for samples and prices

GRIES REPRODUCER CORP.
100 Willow Ave., New York 54, N. Y.



MPB makes more than 50 different types & sizes

Miniature ball bearings for application in precision mechanisms minimize friction and wear. High load capacity. Least weight and space. Special designs and complete engineering service for your application. Write for catalog E.

MPB MINIATURE Precision BEARINGS
INCORPORATED
KEENE, NEW HAMPSHIRE, U.S.A.



ROUND POWER RHEOSTATS

50 to 500 Watt.
Vitroous enameled
UL approved

REX RHEOSTAT CO.
BALDWIN, N. Y.

DESIGN—DEVELOPMENT—MFR

Transformers, Coils
MAGNETIC AMPLIFIERS
Short Runs - Fast Delivery
Low Cost - High Quality

Box 7646, Electronics
330 W. 42nd St., New York 18, N. Y.

SUB-CONTRACTING
MILITARY and COMMERCIAL

receivers — test equipment
transmitters — controls
sub-assemblies

TELETRONICS LABORATORY, INC.
Westbury, L. I., N. Y., Westbury 7-1028

When you're in need of some product or service to speed and improve operation, or save money, you may find it here—in the Contacts Section. . . . each issue.

PROFESSIONAL SERVICES

AMERICAN SPEEDLIGHT CORP.

(AFFILIATED WITH J. G. SALTZMAN, INC.)
 HARRY L. PARKER, PRESIDENT and
 CHIEF ENGINEER
 Specialist in Flash and Electronic Equipment
 for Photography.
 Consultation—Development—Design and
 Manufacture
 480 Lexington Avenue New York 17, N. Y.

HOGAN LABORATORIES, INC.

John V. L. Hogan, Pres.
 Applied Research, Development, Engineering
 Est. 1929. Exceptionally competent staff.
 Electronics, Optics, Mechanisms, Facsimile
 Communication, Electro-sensitive record-
 ing media, Instrumentation.
 155 Perry Street, New York 14 CHelsea 2-7855

CROSBY LABORATORIES, INC.

Murray G. Crosby & Staff
 Radio-Electronic Engineering,
 Research & Development
 F.M. Communications, TV
 Test Equipment
 Offices, Laboratory & Model Shop at:
 126 Herricks Rd., Mineola, N. Y.
 Garden City 7-0284

MEASUREMENTS CORPORATION

Research & Manufacturing Engineers
 Harry W. Houck Jerry B. Minter
 John M. van Beuren
 Specialists in the Design and
 Development of Electronic Test Instruments
 Boonton, N. J.

DUBROW DEVELOPMENT CO.

Design — Development — Mfr.
 Quality Electronic Equipment
 347-9 High St. Burlington, N. J.
 Burlington 3-0446

Eugene Mittelman, E.E., Ph.D.

Consulting Engineer & Physicist
 High Frequency Heating—Industrial Electronics
 Applied Physics and Mathematics
 549 W. Washington Blvd. Chicago 6, Ill.
 State 2-8021

EDGERTON, GERMESHAUSEN & GRIER, INC.

Consulting Engineers
 Research Development and Manufacture
 of Electronic and Stroboscopic Equipment
 Specialists in High-Speed Photography
 160 Brookline Avenue, Boston 15, Mass.

NIAGARA ELECTRON LABORATORIES

CONSULTATION - DESIGN - CONSTRUCTION
 MFG. THE THERMOCAP RELAY
 Specializing in solution of problems of electronic
 and electro-physical instrumentation for the re-
 search or analytical laboratory. Industrial plant
 problems also invited.
 Andover, New York Cable Address: NIATRONLAB

ELECTRONIC ENGINEERING CO. of CALIFORNIA

Radio and Electronic Consulting and
 Designing.
 180 S. Alvarado Los Angeles
 DUnkirk 2-7353 California

PICKARD AND BURNS, INC.

Consulting Electronic Engineers
 Analysis and Evaluation
 of Radio Systems
 Research, Development & Design
 of Special Electronic Equipment
 240 Highland Ave., Needham 94, Mass.

ERCO RADIO LABORATORIES, INC.

Radio Communications Equipment
 Engineering - Design - Development - Production
 Pioneers in Frequency Shift Telegraph
 Garden City • Long Island • New York

ALBERT PREISMAN

Consulting Engineer
 Television, Pulse Techniques, Video
 Amplifiers, Phasing Networks,
 Industrial Appliances
 Affiliated with
 MANAGEMENT-TRAINING ASSOCIATES
 3308-14th St., N.W. Washington 10, D. C.

EDWARD A. GAUGLER, Ph.D.

Consulting Physicist
 Magnetic Materials and Their Applications
 419 Shepherd St. Chevy Chase, Md.

The Robert H. Streeter Co.

Electronic Design Specialists
 Engineering Consultants
 Representing Manufacturers
 of Electronic Equipment
 in Southern United States
 Specialists in the design and construction of spe-
 cialized pieces of equipment for specific applications
 Tel. 97 Greenwood, Miss.

PAUL GODLEY CO.

Consulting Radio Engineers
 GREAT NOTCH, N. J.
 Est. 1926 Little Falls 4-1000

THE TECHNICAL MATERIEL CORPORATION

Communications Consultants
 Systems Engineering
 General Offices and Laboratory
 121 Spencer Place, Mamaroneck, N. Y.

HANSON-GORRILL-BRIAN INC.

Products & Mfg. Development
 ELECTRICAL - ELECTRONIC
 HYDRAULIC - MECHANICAL
 One Continental Hill Glen Cove, N. Y.
 Glen Cove 4-1922

WHEELER LABORATORIES, INC.

Radio and Electronics
 Consulting—Research—Development
 R-F Circuits—Lines—Antennas
 Microwave Components—Test Equipment
 Harold A. Wheeler and Engineering Staff
 Great Neck, N. Y. Great Neck 2-7806

limitation of the use of bifilar coils is the fact that they preclude the use of usual methods of plate-screen neutralization. The reasoning indicated is that the screen is effectively grounded by the transformer secondary. This does not agree with observed experimental findings.

Consider the standard circuit of Fig. 1A. A balanced bridge circuit is obtained, and no feedback voltage appears between grid and ground due to driving voltage across L , when the following relationship is true: $C_{GP}/C_{GS} = C_P/C_N$.

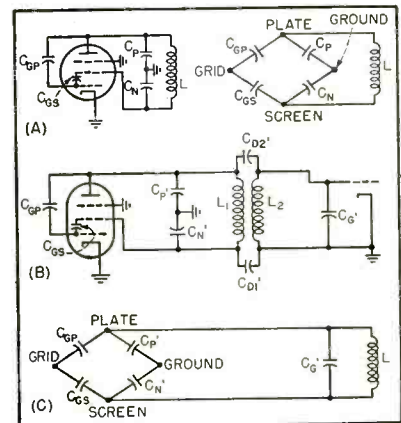

FIG. 1—Neutralization of bifilar coil stages

This method applied to a bifilar stage is shown in Fig. 1B. The screen of the i-f amplifier tube will be close to, but not at, ground potential. Usually, $C_{D1'} \ll C_N$. The effect of $C_{D2'}$ will be to modify the effective driving voltage source of the equivalent bridge circuit. In first order terms, if transformer distributed capacitances are neglected, and $L_1 = L_2 = L$, and $k = 1$, the bridge circuit becomes that shown in Fig. 1C.

Neutralization is obtained when $C_{GP}/C_{GS} = C_P'/C_{N'}$. For identical conditions, $C_{N'}$ is smaller than C_N . The bridge in the bifilar case will be more subject to unbalance due to tube wiring changes, and so on. Also, if $C_{N'}$ is too small, Miller effect might prevent proper bridge balance conditions. Neutralization of bifilar i-f stages has been obtained, though, in development work conducted by associates of the writer.

EDWARD S. WHITE
 RCA Industry Service Laboratory
 New York, N. Y.

Engineers - Executives - Technical Men

Salaried Positions, \$4,000 to \$30,000. This Confidential service for men who desire a new connection, will develop and conduct preliminary negotiations without risk to present position. Send name and address for details.

TOMSETT ASSOCIATES
1207-2 Berger Bldg., Pittsburgh 19, Pa.

REPLIES (Box No.): Address to office nearest you
NEW YORK: 330 W. 42nd St. (18)
CHICAGO: 520 N. Michigan Ave. (11)
SAN FRANCISCO: 68 Post St. (4)

POSITION VACANT

INSTRUMENT ENGINEER, experienced in watch manufacture, design, electronics. Good position with excellent future. Good living and working conditions in Midwestern Suburb. State age, experience and salary desired in application. P 7732, Electronics.

EMPLOYMENT SERVICE

SALARIED PERSONNEL, \$3,000-\$25,000. This confidential service, established 1927, is geared to needs of high grade men who seek a change of connection under conditions assuring, if employed, full protection to present position. Send name and address only for details. Personal consultation invited. Jira Thayer Jennings, Dept. L, 241 Orange St., New Haven, Conn.

POSITIONS WANTED

PHYSICIST, M.A. Columbia, 1 yr. exp. microwaves, strong interest mathematics, desires stimulating position, research or development, NYC area. PW-7636, Electronics.

PURCHASING AGENT, Electronic Components, Exp., Jobber, research labs, war surplus; Inv. control; supervision. N.Y.C. area. Know materials, sources, systems. PW-7568, Electronics.

ELECTRO-MECHANICAL Design Engineer. M.E. and E.E. degrees. Age 33. At present Computer Project Engineer. Desires responsible position in the electro-mechanical field, requiring original and imaginative engineering. Salary \$8,000. ATwater 9-0744. PW-7593, Electronics.

ELEC. ENGR, BEE June 1950, Cornell. 22, Single. 2 years technician, broadcast operator, etc. Desire electronic circuit design, development. PW-7663, Electronics.

UHF SPECIALIST, Graduate of German Techn. University; 7 yrs Telefunken, Berlin; Section Chief of uhf lab; 2 yrs T.T.&T. Frankfurt; Plant Eng.; 2 1/2 yrs AFN Frankfurt, Germany; Chief Transm. Eng. Age 37; available November 1950. PW 7695, Electronics.

SPECIAL SERVICE**Photo-Retouching (Airbrush).**

Exploded views, cutaway rendering and top quality photo-retouching for clarity in your sign details. Instruction manuals, advertising and catalogues. Hirshon Photo-Retouching Service, 113 West 42nd St. LO 4-8163.

WANTED

ANYTHING within reason that is wanted in the field served by Electronics can be quickly located through bringing it to the attention of thousands of men whose interest is assured because this is the business paper they read.

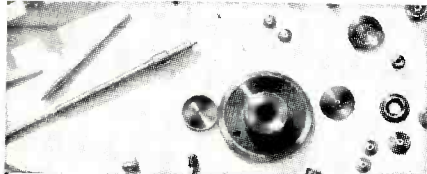
**SMALL PARTS**

Made to "watchmaker's tolerances".

Mechanical, electromechanical, small instrument. Small parts designed, manufactured, sub-assembled by long-established manufacturer.

Precision Products Division

OSTBY & BARTON CO.
118 Richmond St., Providence, R. I.

**WANTED**

We will pay top prices for electronic surplus equipment and components.

ELECTRONIC SURPLUS BROKERS

3232 Broadway

FOR SALE

We maintain a large and varied stock of top-grade electronic materials. Ask us to quote on your requirements.

New York 27, N. Y.

WANTED!!

Telephone Handsets
Antennas AN131 & 130
Trimmer Condensors

State Type & Quantity

W-7625, Electronics
330 W. 42nd St., New York 18, N. Y.

WANTED

ONE USED 240 CYCLE GENERATOR

Single phase 110 or 220 V. AC., 1 to 2 K.V.A.

ADVANCE TRANSFORMER CO.

1122 West Catalpa Avenue, Chicago 40, Illinois

WANTED

FREQUENCY CHANGER

7 1/2 to 10 kva, from 60 to 180 cycle, primary 208 volt, three phase. Send full description and price.

THE ARKAY COMPANY

864 Newark Avenue Jersey City 6, N. J.

WANTED

INSULATORS; POLE LINE HARDWARE; GUY STRAND WIRE; COPPERWELD WIRE; WESTERN ELECTRIC TOOLS; SPLICING SLEEVES.

VICTOR-BERNARD INDUSTRIES

NE Cor. 22nd & Lehigh Aves., Phila. 32, Pa.

WANTED

WESTERN ELECTRIC VACUUM TUBES

Types 101F, 102F, 272A, 274A or B, 310A or B, 311A, 313C, 323A, 328A, 329A, 348A, 349A, 352A, 373A, 374A, 393A, 394A, 121A Ballast Lamps.

W-6863, Electronics
330 W. 42nd St., New York 18, N. Y.

WANTED TO BUY

PRIVATE LABORATORY Wishes To Purchase For Its Own Use High Grade Test Equipment and Basic Radio Components. Replies Held in Confidence.

W-7719, Electronics
330 W. 42nd St., New York 18, N. Y.

ADDITIONAL POSITIONS VACANT ADS

on pages 292, 293 & 294

FOR SALE ADS

on pages 295-318

INSTRUMENT WIRE

1,000,000 feet, gauges 14 to 22, tinned copper, single conductor stranded, cellulose acetate synthetic resin, glass braid insulation jan specs. Variety of colors.

RAYTHEON MFG. CO.

SURPLUS SALES DEPT.

Waltham, Mass. 5-5860, Ext. 2

GOV'T SURPLUS

Ceramics, micas, bathtubs, oils, sockets, trimmers, chokes, Xformers, pots, relays, synchros, Link Xmitters.

EMPIRE ELECTRONICS

Box 102

LEFFERTS STATION, BROOKLYN 25, N. Y.

For Sale at 50% below market prices
75 lbs each Molybdenum strips .006 x 1.25 and .008 x 1/2 also quantity of Tungsten, Molybdenum, Tantalum, Kovar, in wire, ribbon, rods, mesh, strips, tubing, and contact points. Also high vacuum pumps, and other equipment used in lamp and other tube industries.

F. ALEXANDER

115 W. 23rd Street, New York, N. Y.
Watkins 4-8790

FOR SALE

2000 1 MF 400 VOLT Bathtub Condensers
80 Diehl SSFJ7 Syncros

G. C. WILSON

BOX 8 CHATHAM N. J.

**WHAT DO YOU NEED?
WHAT HAVE YOU TO SELL?**

ELECTRONIC SURPLUS

GOULD GREEN, 252 GREENWICH ST., N.Y.C. 7

WANTED

Teletypewriters complete, components or parts. Any quantity and condition.

W-6864, Electronics

330 W. 42nd St., New York 18, N. Y.

WANTED

Boonton 160A, 170A Q Meter;
GR916A RF bridge,
GR 736A Wave Analyzer

Give details to

W-7720, Electronics
330 W. 42nd St., New York 18, N. Y.

**RADAR,
COMMUNICATIONS
and
SONAR
TECHNICIANS
WANTED**

For Overseas Assignments

Technical Qualifications:

1. At least 3 years' practical experience in installation and maintenance.
2. Navy veterans ETM 1/c or higher.
3. Army veterans TECH/SGT or higher.

Personal Qualifications:

1. Age, over 22—must pass physical examination.
2. Ability to assume responsibility.
3. Must stand thorough character investigation.
4. Willing to go overseas for 1 year.

Base pay, bonus, living allowance, vacation add up to \$7,000.00 per year. Permanent connection with company possible.

Apply by Writing to
A-1, P. O. Box 3414
Philadelphia 22, Pa.

Men qualified in RADAR, COMMUNICATIONS or SONAR give complete history. Interview will be arranged for successful applicants.

**RESEARCH ENGINEERS
ELECTRICAL ENGINEERS
AND PHYSICISTS**

THE FRANKLIN INSTITUTE

Laboratories for Research and Development

have openings for personnel with 2-10 years experience. Advanced degrees are desirable in certain of the positions. Fields of interest covered are: Mathematical Analysis of Physical Problems, Statistical Theory of Communications, Electromagnetic Theory, Circuit Analysis, Servomechanism Theory, Electrical Computing, Advanced and Fundamental Circuit Development, Radar and Pulse Circuits, Supervision of Operation of G.C.A. or Tracking Radar, Air Traffic Control Air Navigation, Automatic Controls, Industrial or Marine Power Drives, and Electrical Machinery.

Send resume of education and experience, salary requirements and photograph to:

Personnel Department

THE FRANKLIN INSTITUTE
Philadelphia 3, Pennsylvania

**RCA VICTOR
Camden, N. J.
Requires Experienced
Electronics Engineers**

RCA's steady growth in the field of electronics results in attractive opportunities for electrical and mechanical engineers and physicists. Experienced engineers are finding the "right position" in the wide scope of RCA's activities. Equipment is being developed for the following applications: communications and navigational equipment for the aviation industry, mobile transmitters, microwave relay links, radar systems and components, and ultra high frequency test equipment.

These requirements represent permanent expansion in RCA Victor's Engineering Division at Camden, which will provide excellent opportunities for men of high caliber with appropriate training and experience.

If you meet these specifications, and if you are looking for a career which will open wide the door to the complete expression of your talents in the fields of electronics, write, giving full details to:

National Recruiting Division
Box 910, RCA Victor Division
Radio Corporation of America
Camden, New Jersey

RESEARCH - DEVELOPMENT - ENGINEERING

A progressive electronic research and development organization, contemplating expansion of personnel and facilities in an Eastern research center, is interested in contacting qualified engineering and scientific personnel experienced in electronics, physics, mechanics and administration. Send complete resumes to

THE APPLIED SCIENCE CORPORATION OF PRINCETON, Post Office Box 44, Princeton, N. J.

**ENGINEERING
OPPORTUNITIES
In Westinghouse**

Wanted:

DESIGN ENGINEERS
FIELD ENGINEERS
TECHNICAL WRITERS

Must have at least one year's experience.

For work on airborne radar, shipborne radar, radio communications eqpt., micro-wave relay, or micro-wave communications.

Good pay, excellent working conditions; advancement on individual merit; location Baltimore.

Send resume of experience and education to: Manager of Industrial Relations,

WESTINGHOUSE ELECTRIC CORP.
2519 Wilkens Ave. Baltimore 3, Maryland

**NATIONAL UNION
RESEARCH DIVISION**

Electrical Engineers and Physicists are needed for research on Cathode Ray, Subminiature, Secondary Emission and other types of Vacuum Tubes.

Permanent interesting positions are available in the following fields:

Tube design & development
Tube processing
High vacuum systems
Solid state physics
Electron optics
Phosphorescence

Men qualified in any of the above are invited to send their resumes to:

Divisional Personnel Manager
National Union Research Division
350 Scotland Rd., Orange, N. J.

**PHYSICISTS
SR. ELECTRONIC ENGINEERS**

Familiar with ultra high frequency and micro wave technique. Experience with electronic digital and/or analog, computer research and development program. Salaries commensurate with experience and ability. Excellent opportunities for qualified personnel.

Contact:

C. G. Jones, Personnel Department
GOODYEAR AIRCRAFT CORPORATION
Akron 15, Ohio

OPENINGS for ENGINEERS

America's fastest growing and leading manufacturer of automatic control equipment has a number of attractive openings for electrical and mechanical engineers with research, design or development experience in the following areas: Electronics, Servo Mechanisms, Small Electro-Mechanical Devices, Relays, Electro Magnetics and related activities. Excellent opportunities for advancement. Attractive salaries. Location: Minneapolis. Write giving full particulars to B. J. Walker, Employment Manager.

MINNEAPOLIS-HONEYWELL REGULATOR CO.
2743 Fourth Avenue South
Minneapolis 8, Minnesota

SENIOR ELECTRONIC CIRCUIT PHYSICISTS

for
*Advanced Research
and Development*

MINIMUM REQUIREMENTS:

1. M.S. or Ph.D. in Physics or E.E.
2. Not less than five years experience in advanced electronic circuit development with a record of accomplishment giving evidence of an unusual degree of ingenuity and ability in the field.
3. Minimum age 28 years.

Hughes Aircraft Company
Attention: Mr. Jack Harwood
CULVER CITY, CALIFORNIA

ELECTRONIC ENGINEERS

BENDIX RADIO DIVISION
Bendix Aviation Corporation

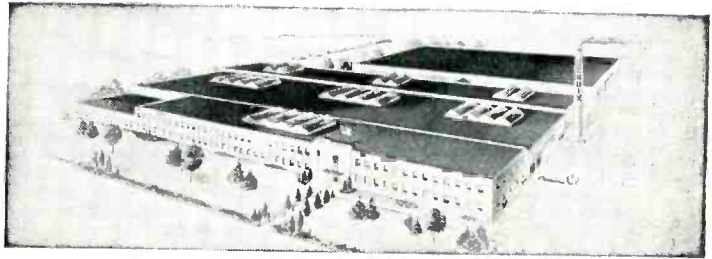

PRODUCTION DESIGN RESEARCH

Bendix Radio Division, a leader in the field of high quality radar and communications equipment, has positions for engineers experienced in the design and development, for production, of radio and radar equipment or electronic research.

Positions are available at all salary levels.

Good advancement opportunities, air-conditioned plant in suburban location, excellently equipped laboratories, technical library, large experimental engineering model shop.

Housing and rentals in Baltimore are plentiful.

Interviews will be held in Baltimore, Chicago and New York.
Please send resume of experience promptly to:

MR. W. L. WEBB, Director Engineering and Research
BENDIX RADIO DIVISION
Bendix Aviation Corporation • Baltimore 4, Maryland

Physicists Mathematicians Electronics Engineers Mechanical Engineers

Cornell Aeronautical Laboratory, an affiliate of Cornell University, has permanent positions open for men of project engineer caliber with advanced degrees and experience in physics, applied mathematics, electronics, and instrument design. Assignments are varied and professionally challenging in fields of pure and applied physics.

The position of our laboratory is between those of universities and commercial research institutes. We believe it combines many of the traditional advantages of both.

Inquiries will be treated as confidential; they should be addressed to

Mr. Nathaniel Stimson,
Dept. F, Cornell Aeronautical Laboratory,
P.O. Box 235, Buffalo 21, New York

Bachelors, Masters, Ph.D's in PHYSICS or E.E.
Experienced electronic engineers;
supervisory personnel for vital war work

OPPORTUNITY ON LONG ISLAND

for research minded engineers

Offers attractive working conditions, salary commensurate with experience, access to graduate schools, first-rate research and development facilities; other advantages.

Projects underway in fields of microwave receivers, transmitters, antennas; radar, air traffic control; servos, motor control systems; general electronics.

Write PERSONNEL MANAGER

Airborne Instruments Laboratory
INCORPORATED

160 OLD COUNTRY ROAD · MINEOLA, N.Y.

WANTED

MANUFACTURER'S REPRESENTATIVE

Must be sales ENGINEER. To handle growing line of electronic test instruments which now includes oscillators, DC amplifiers, transducers, electronic potentiometers, electronic DC and AC voltmeters, megohmmeters, bridges, and others. Some good territories are still open. Send qualifications to

Southwestern Industrial Electronic Co.
P. O. Box 13058 Houston 19, Texas

SALES MANAGER

With good background in Vacuum Tubes and Govt. contracts. Must have good following in the industry and a record of ability. Must be free to travel. Established well-known firm. Send detailed Resume of experience. Interview will be held in New York area.

SW 7630 Electronics
330 W. 42 St. New York 18, N. Y.

ENGINEERS

RESEARCH and DEVELOPMENT

Career Positions
for
Top Engineers and Analysts

SENIOR ELECTRONICS AND ELECTRONICS ENGINEERS—B.S. or M.S. degree; 2 to 7 years experience in radar, television, pulse, video or display circuit design.

DIGITAL COMPUTER DESIGN ENGINEERS
AUTOMATIC TELEPHONE SWITCHBOARD DESIGN ENGINEER

SENIOR ELECTRO-MECHANICAL ENGINEERS—Degree and at least 4 years experience in servo-mechanism analogue computers, special weapons or system design.

For Interview in Chicago
Contact

The Glenn L. Martin Company
Representative
Attending National Electronics Conference
at Edgewater Beach Hotel
September 25 - 27, 1950

SENIOR ELECTRONIC ENGINEERS

Prominent New England Company needs a number of top-flight engineers, skilled on pulse circuits, microwave circuits and R. F. techniques. Minimum of at least 6 to 8 years experience. Attractive salary—Group insurance—Pension Plan—Paid vacation. Please write giving complete resume of education, experience and salary expected.

P-7551, Electronics
330 W. 42nd St., New York 18, N. Y.

ELECTRICAL and MECHANICAL ENGINEERS

Openings for experienced design and production engineers. Must have had design experience in mechanical, electrical, or electronic aspects of small intricate mechanisms. Design of servo-mechanisms, communications equipment, small power tools, sewing machines, vacuum cleaners, business machines, etc., is the type of experience desired. A degree in mechanical or electrical engineering is preferred but is not required. Give full details of education, experience, and personal history. Permanent positions with well-established firm located in central New York State.

P-7175, Electronics
330 W. 42nd St., New York 18, N. Y.

PROJECT ENGINEERS

Five years or more of experience in charge of design and development of radio and communication equipment. Must be a graduate of a credited Engineering School. Well equipped laboratory in modern radio and television plant, with excellent opportunities for advancement.

Send resume of qualifications to Mr. S. F. Cascio, Personnel Director of the Hallcrafters Company
4401 West Fifth Ave., Chicago 24, Illinois

ENGINEERS— PHYSICISTS

SENIORS

- What do you want in a position?
- What are your aims and ambitions?

The W. L. Maxson Corporation offers special opportunities if you are heavily experienced in research and development on radar, computers and associated equipment.

Please address your job requirements and resume to A. Hoffsommer for individual attention.

THE W. L. MAXSON CORPORATION
460 W. 34th St., N. Y. 1, N. Y.

DEVELOPMENT WORK at WESTINGHOUSE

There is an opening for an aggressive, alert, well-informed, and tactful physicist or electrical engineer with experience in the fields of magnetic materials, test devices for studying magnetic properties, and magnetic amplifiers, for development work which may cover any of the above mentioned fields. Salary commensurate with qualifications. For application write

Manager, Technical Employment,
Westinghouse Electric Corporation,
306 Fourth Avenue, Pittsburgh 30,
Pa.

WANTED

Key Production Executive

For smaller electronic plant in midwest. An unusual opportunity with a long established firm for executive participation as production member of executive team. Essential qualifications: Age 30 to 50. Experience in production management with an electrical or electronics manufacturer involving methods, supervision, production control, labor management and efficiency. Educational background of M.E. or E.E. helpful but not essential if candidate has adequate background and experience. Present staff knows of this ad. Written applications treated in confidence.

P-7560, Electronics
520 No. Michigan Ave., Chicago 11, Ill.

ELECTRONIC ENGINEERS WRITE FOR JOB IN SAN DIEGO NOW

We need engineers for electronics research development and production. Real opportunity for graduate engineers with 5 or more years experience in basic circuit design, pulse, micro-wave, system analysis, electronic project coordination and administration. Openings for project leaders, senior designers, assistant project leaders and staff specialists.

Congenial associates, and superior living conditions in wonderful San Diego. Write today to H. T. Brooks, Engineering Personnel Office, Consolidated Vultee Aircraft Corporation, San Diego, California.

AIRCRAFT ANTENNA DEVELOPMENT SUPERVISOR

To assume the responsibilities for the development, design and evaluation of airborne antenna for military aircraft. Full knowledge of measurement techniques and 8 to 10 years of related experience required.

Also several openings for junior engineers in this field.

Write qualifications to

Employment Office
CHANCE VOUGHT AIRCRAFT
Box 5907, Dallas, Texas

Opportunity with Manufacturer of Electronic, Electro-Mechanical and Radiation Instruments.

1. Senior Electronics Engineer
Requirements:
5 years experience in design and development of pulse circuits, computers, nuclear instrumentation or video circuits required. Manufacturing or production experience desirable.
2. Production Engineer
Requirements:
5-10 years experience as electronic and mechanical instrument production engineer in small lot production. Thorough electronic theory grounding.

Send complete resumes and salary requirements.
BERKELEY SCIENTIFIC COMPANY
P. O. Box 1826 Richmond, California

SEVERAL ENGINEERS

Needed by contractor for work at Naval Air Missile Test Center, 50 miles northwest of Los Angeles. College Degree and experience essential. Radar, digital computer or general pulse technique experience required.

**ELECTRONIC ENGINEERING CO.
OF CALIFORNIA**
180 South Alvarado Street
Los Angeles 4, California

NEW ADVERTISEMENTS

will be accepted for the SEARCHLIGHT SECTION of the November issue of ELECTRONICS until September 29th.

Undisplayed rates: \$1.20 per line, per insertion. (1/2 of this rate for Positions Wanted Ads).

Displayed rates: On a transient basis, \$12.80 per inch, per insertion. Lower contract rates are available. Send advertisements directly to

Classified Advertising Division

ELECTRONICS

330 W. 42nd St., N. Y., 18, N. Y.

AMPLIFIERS
AN CON-
NECTORS
CABLE
CAPACITORS
CHOKES
CIRCUIT
BREAKERS
COAX
CONNECTORS
COILS
CORDS
CRYSTALS
DELAY LINES
FILTERS
FUSES

CONDENSERS



MICA
SOLAR XMB
TAPPED HOLES

Mfd.	Price
2500 V Test	\$0.29
00001	\$0.29
000025	\$0.29
00003	\$0.29
00005	\$0.29
000075	\$0.29
0001	\$0.29
00015	\$0.29
00025	\$0.29
0003	\$0.29
0004	\$0.29
0005	\$0.29
00075	\$0.35
00085	\$0.35
001	\$0.35
0015	\$0.35
0016	\$0.35
0017	\$0.35
002	\$0.50
0023	\$0.50
003	\$0.50
004	\$1.79
005	\$1.79
006	\$1.79
0063	\$1.79
0069	\$1.79
007	\$1.79
0075	\$1.79
0076	\$1.79
008	\$1.79
01	\$1.10
015	\$1.10
02	\$1.10
025	\$1.10
027	\$1.10
03	\$1.10
5000 V Test	\$1.75
0015	\$2.00
002	\$2.00

SOLAR XO
Solder Lugs
2500 V Test

01	\$0.85
015	\$0.85
02	\$0.85
04	\$0.85
001	\$0.60
0015	\$0.60
002	\$0.60
0022	\$0.60
0023	\$0.60
0024	\$0.60
0025	\$0.60
0027	\$0.60
003	\$0.60
004	\$0.60
005	\$0.60
0056	\$0.60
006	\$0.60
0063	\$0.60
0075	\$0.60
0076	\$0.60
008	\$0.60
0085	\$0.60
0005	\$0.60
00085	\$0.60
00015	\$0.60

Write For Many Others

CONDENSERS

Mfd.	Price
2500 V Test	\$0.29
00001	\$0.29
000025	\$0.29
00003	\$0.29
00005	\$0.29
000075	\$0.29
0001	\$0.29
00015	\$0.29
00025	\$0.29
0003	\$0.29
0004	\$0.29
0005	\$0.29
00075	\$0.35
00085	\$0.35
001	\$0.35
0015	\$0.35
0016	\$0.35
0017	\$0.35
002	\$0.50
0023	\$0.50
003	\$0.50
004	\$1.79
005	\$1.79
006	\$1.79
0063	\$1.79
0069	\$1.79
007	\$1.79
0075	\$1.79
0076	\$1.79
008	\$1.79
01	\$1.10
015	\$1.10
02	\$1.10
025	\$1.10
027	\$1.10
03	\$1.10
5000 V Test	\$1.75
0015	\$2.00
002	\$2.00

SOLAR XO
Solder Lugs
2500 V Test

01	\$0.85
015	\$0.85
02	\$0.85
04	\$0.85
001	\$0.60
0015	\$0.60
002	\$0.60
0022	\$0.60
0023	\$0.60
0024	\$0.60
0025	\$0.60
0027	\$0.60
003	\$0.60
004	\$0.60
005	\$0.60
0056	\$0.60
006	\$0.60
0063	\$0.60
0075	\$0.60
0076	\$0.60
008	\$0.60
0085	\$0.60
0005	\$0.60
00085	\$0.60
00015	\$0.60

Write For Many Others



Trimmer Cond. Variable

15 MMF	21¢ ea.
20 MMF	
40 MMF	
50 MMF	
60 MMF	

PROJECTION LAMPS
RECORDERS
RESISTORS
SELSYNS
SCOPE
ACCES.
SHOCK
MOUNTS
SOCKETS
SWITCHES

Ceramicons

Mimt	Price
1	25
3	27
4	35
3.4	35
6	47
7	50
2500	15
3000	15
300	25
500	25
1000	30
1000	35
1000	35
2000	50
3x290	50
500	80
125	150
250	150
1000	1.69
2x1000	6
75	250

\$7.50 per 100 Feed
Button Thru 50
180 200
175 500
185 108
\$8.50 per 100



SCREW MTG
Wirelead D TYPE

Mfd	Price
4	\$0.35
8	25
8-8	450
16	450
20	450
30	450
29	250
12	250
8	600
8	450
16	450
30	450
20	150
240	250
30-30	450



MINICAPS
PIGTAIL

Mfd.	Price
30	\$0.49
30	45
30	45
40	45
40	525
16	350
16	525
16	450
16	100
20	25
20	80
20	450
24	350
8	150
10	150
10	50
4	50
4	150

Birtcher
Tube Clamps

926-C	60
926-16	60
926-B1	60
926-B2	60
926-B8	60
926-C15	60
926-C-13	60
926-C-19	60
926A-16	60
926A-14	60
926C11	60
926A11	60
926-B31	60
926C-23	60
929-1	80
926B-10	80
926B-18	80
926-K2	80

Each 15¢
10 \$1.40
100 \$12.00

TUBES!

Write or phone your needs

PE 157 VIBROPACK
FOR BC 745

Runs on 2V DC. Obtained from small Willard Rechargeable battery contained in case which is charged from 6 Vac or DC. Also contains 5" PM Speaker & Jacks for Mike. Used, excellent \$9.95

RECTIFIER CAPACITORS

Mfd	Price
6000	12
1000	15
3000	15
2500	15
300	25
500	25
1000	30
1000	35
1000	35
2000	50
3x290	50
500	80
125	150
250	150
1000	1.69
2x1000	6
75	250

Wholesale Qty's Available

110 volt AC CONDENSERS

Mfd	Price
20-24	1.00
26-30	1.00
31-37	1.00
38-42	1.00
43-48	1.00
49-55	1.25
50-75	1.25
72-87	1.25
86-96	1.45
88-106	1.50
107-129	1.75
124-138	1.75
130-150	1.75
130-180	1.90
161-180	1.75
158-191	2.00

Many others in stock

HIGH CURRENT MICAS

60	300
30	450
32	450
30-30	150
70-30	150
30-20	350-25
10-20	450
40-20-20	150
40-30-20	150-25
50-50-20	150-25
60-40-10	150-25
60	300
30	450
32	450
30-30	150
70-30	150
30-20	350-25
10-20	450
40-20-20	150
40-30-20	150-25
50-50-20	150-25
60-40-10	150-25

Ceramic Case

120 MMF	\$19.00
10KVW	
30 MMF	19.00
10KVW	
.08 MFD	10.00
1500	10.00
.045 MFD	12.00
2000	12.00
.0001	24.00
.0051	21.00
15 KVW	21.00
.001 25 K	35.00

Available in Stock

Large Qty's.

Amphenol Connectors

Write for List

BC 620 Mobile Rec. 20-27 MC w/Tubes. Excellent Cond. \$15.95

PE117 Power Supply Less Vibrator Cond. & Tubes. Price \$5.95

HORSIE TALKIE BC745 Xmttr Rcvr. 3-0 MC w/I T.U. Less Power Supply \$12.00

BC 429 Rcvr or Xmttrs Designed for Mobile and Aircraft 2000 to 9050 Kc or Xmitting 187-13050 for Rcvr. Using T.U. 12-15 watt Rec Less T.U. \$3.95 Xmttr Less T.U. \$3.95

ARR2 H.M.-ING REC. Tunes 234-258 Mc. Contains 4-6AK5, 6-3001, 1-12A6. Ideal for 2-0-10 Meter Conv. Less Dyn. As is fair \$7.95



ELECTROLYTICS

Prono Mount D. Y. Type

Type	Volts	Amps.	Volts	Amps.	Set
PE86	28	1.25	250	.060	RC 36
DM416	14	6.2	330	.170	RU 19
DY-2/ARR-2	28	1.1	250	.060	ARC-5
DM36	28	1.4	220	.050	BC 367
DM25	12	2.3	250	.070	BC 348
	28	1.25	275	.050	BC 456
DM31A	28	7	540	.110	SCR 506
DM42	14	46	515	1030	.050

10 for \$1.75

18c ea.

Mfd. Volt

40	150
80	150
10	200
8	450
16	450
10-10	150
20-20	150
40-40	150
20-30	250
3x20	450
30	350
80	350
10	450
15	450
30-30	25
20-10	150
50-30	150
20-1	350
10-1	300

29c ea.

10 for \$2.75

60	400
50	400
40	450
30-20	150
50-50	150
20-20	350-25
20-20	400-25
40-20	150
40-30-20	150-25
50-50-20	150-25
60-40-10	150-25
60	300
30	450
32	450
30-30	150
70-30	150
30-20	350-25
10-20	450
40-20-20	150
40-30-20	150-25
50-50-20	150-25
60-40-10	150-25

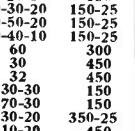

CHOKE SWINGING

9/60 Hy 400/.05 MA. 1000 volt test. Mfg. Super \$8.95

There Are No Shortages of Equipment at C.E.C.

Our warehouses are full of surplus radio, radar, electronic equipment, for your needs, as a manufacturer, jobber, amateur, experimenter, engineer, everything at surplus prices. We own what we sell, phone or write us your needs and let us quote.

Mr. Chas. Rosen
Digby 9-4124

BC 929 SCOPE 3" Oscilloscope using 9 tubes. 3BP1, 6SN7, 6H6, 6BQ6, 6X5, 2X2. (Now 400 cy) easily converted to 60 cy. Complete w/tubes \$24.95

Voltage Stabilizer VR3 95-130V 2.4A 60CY 1/2 Out. 115V 120 Watt 100% Mfg. Raytheon w/ert Bx Box. Sockets & cable used but good \$19.95

Voltage Regulator VH623 95-130V 1.76A 60CY 1/2 CU 115V 150 Watt 100%. Slightly used, excellent \$19.95

BC-733D SUPERHET RECEIVER w/10 Tubes, 6 Selector-Relays Operate on Xmttr Controlled Freq. 108.3-110.3 MC. Can easily be converted to 2 Mtr. ham bands

RS/ARN 7 Compass Rec. ADF Rec. 100 to 1750 KC. in 4 Bands 5-Gang Tuning Capacitor w/15 Tubes. 4-6K7, 1-6L7, 1-6I5, 2-6B8, 2-6F6, 1-6N7, 1-6SC7, 2-6Q51, 1-524. Exc. \$20.00

866 Filament Xfmr 2x2.5v 6 Amp 8000 V Test Size. Approx 3/2" SQ. Easy to Mount. Price \$2.95

Input Output Radio

Type	Volts	Amps.	Volts	Amps.	Set
BD AR 93	28	6.3	800	.020	
23350	27	1.75	285	.075	APN-1
35C045B	28	1.2	250	.060	
ZA .085	12/24	4/2	500	.050	
ZA .056	12/24	8/4	12/275	3/110	
B-19 p ck	12	9.			

RADAR
RADAR
RADAR
RADAR

R
A
D
A
R

SONAR
SONAR
SONAR
SONAR

SONAR

QCQ2. ECHO RANGING AND LISTENING EQUIPMENT

Use: Medium ASW ships.
Keying interval, 1,000, 2,000, 4,000, 8,000 yards and manual.
Projector. Magnetostrictive, permanent magnet polarization, resonant frequency about 25 kc.
Transmitting system. The electron tube driver oscillator and two amplifier stages are contained in the receiver chassis; the variable tuning condenser being ganged with the receiver tuning condensers in order to give uni-control of receiver and driver tuning. In another chassis are located the output tubes and the high voltage rectifier. Sweep frequency modulation is provided, giving a shift from 400 cycles below to 600 cycles above the operating frequency during the transmission.
Receiving system. The receiver is of the tuned-radio-frequency type. It includes time varied gain, to reduce the volume of reverberations immediately following the transmission, and has a "Flat-Peak" audio filter, and an adjustable BFO to give an audible note above or below 800 cycles.
Keying and indicating system. Keying is mechanical; cams in the indicator unit determine the pulse length and keying interval. Ranges are indicated by the flash of a neon lamp.
Complete sets available less hoist. Also stacks alone.

QBF AND QJA. ECHO RANGING AND LISTENING EQUIPMENT

Use: Large ASW ships.
QBF may be converted by field modification, to QJA available.
Keying interval, 1,000, 2,000, 3,000, 4,000, 5,000, 10,000 yards and manual.
The electrical train system consists of a handwheel on the stack which selects, by commutation, three voltages from the secondary of a transformer-like device called a Commutator Transmitter.
Projector. The projector is of the Rochelle salt crystal type with a single element used for both listening and ranging. The frequency is 22 to 28 kc.
Transmitting system. The receiver-driver oscillator unit contains two electron tube oscillators, one fixed at about 150 kc and one tunable over the range from 160 to 180 kc. The outputs of the two are mixed, producing a difference frequency, which is then fed to the driver-amplifier unit and thus to the projector.
Receiving system. The receiver is a superheterodyne type covering the range from 10 to 30 kc.
Keying and indicating system. Ranges are indicated by the flash of a neon lamp which revolves at a constant speed, driven by a synchronous motor.

QCU, QCU-1 ECHO RANGING AND LISTENING EQUIPMENT

Use: Small ASW ships.
Intended to be used as a replacement for the obsolete WEA-1 equipment the old hoist.
Keying interval, 1,000, 2,000, 4,000, 8,000 yards and manual.
Training is electrical, controlled by hand crank at the remote station.
Projector. Magnetostrictive, permanent magnet polarization, resonant frequency about 25 kc, split for BDI.
Transmitting system. The electron tube driver oscillator and two amplifier stages are contained in the receiver chassis; the variable tuning condenser being ganged with the receiver tuning condensers in order to give uni-control of receiver and driver tuning. In another chassis are located two type 811 output tubes and two type 830 high voltage rectifiers. Sweep frequency modulation is provided, giving a shift from 400 cycles below to 600 cycles above the operating frequency during the transmission.
Receiving system. The receiver is of the tuned radio frequency type. It includes time varied gain, to reduce the volume of reverberations immediately following the transmission, and has a "Flat-Peak" audio filter, and an adjustable BFO to give an audible note, above or below 800 cycles.

QCS, QCS-1, QCT-1 ECHO RANGING AND LISTENING EQUIPMENT

Use: ASW ships.
Keying interval (original).—1,000, 2,000, 5,000, 10,000 yards and manual (field modification added 3,000 and 4,000 yards)
Transmitting system. The driver-rectifier unit contains an electron-tube oscillator tunable over the range of 17 to 25.5 kc, and electron-tube amplifier and a rectifier power supply.
Receiving system. The superheterodyne receiver covers the range from 13 to 37 kc and may be connected by a selector switch to either the "Q" or the "K" face of the projector. It has separate audio amplifiers for the range indicator lamp and for the loud-speaker. The audible note may be adjusted over the range from 0 to 1600 cycles. Three degrees of 1-f selectivity and two of audio are provided by selector switches connected to filters.
Keying and indicating system. Keying is mechanical; cams driven by the range indicator disc shaft determine the pulse length and keying interval.

THE MUST OF THE MONTH

Complete 3 CM Radar System equipment 40 KW peak transmitter, pulse modulator, receiver, using 723AB, power supply operating from 115V 300 Cycle, antenna system. Complete radar set neatly packaged in less than 10 cubic feet, all tubes, in used but excellent condition \$350.00. This price for laboratories, schools, and experimental purposes only.

High Voltage Power Supply

15 KV at 30 Ma OC, Bridge Rectifier, Western Electric... \$125.00

FM STATION

General Electric Kilowatt Amplifier
Model 4BT2A1 Type BT2A Serial RC25
General Electric 250 Watt Exciter
Model 4BT1A1 Type 3T1A Serial CC833
General Electric Station Monitor
Model 4BM1A1 Type BM1A Serial WC268
General Electric Power Supply
Model BP211 Type BF2A Serial WC547
General Electric Transmitter Console
Model 4BC3A1 Type BC3A Serial WC5
Type BX-2A Two Bay Circular Antenna with Mast, Transmission Line, Elevators and Matchers.
100 Feet of 1 1/2 coax. transmission line including 90° elbows.
Dehydrator for transmission line.
Desk and Chair for Transmitter Console.
Write or phone for data & price.

All merch. guar. Mail orders promptly filled. All prices F.O.B. N.Y.C. Send MO or Chk. Only shipping chgs sent C.O.O. Rated concerns send P.O.

COMMUNICATIONS EQUIPMENT CO.

131 Liberty St., New York, N. Y. Dept. E-10 P. J. Plishner Phone: Digby 9-4124

APS-2. 10 cm. airborne radar set designed for navigation and high altitude bombing. The antenna rotates through 360 degrees. Presentation is PPI and A Scope. The following units of the set are supplied: Antenna, transmitter-receiver, modulator, indicator, 24VDC input power unit. New with all tubes, incl. 714AY magnetron, 417A klystron.

APS-3. 3cm. airborne radar set designed for intercept of enemy aircraft and nominal navigation. Antenna is sector scan. Remote as well as master indicator is supplied. 725A magnetron operates the set at 45kw. Complete sets available with all tubes incl. magnetron and 723AB klystrons. Both new and used condition.

APS-4. 3 cm. airborne radar set designed for sector scan surface search, mapping and navigation, weather forecasting, intercepting of enemy aircraft. Entirely enclosed in a streamlined housing for optional mounting on aircraft bomb rack, or on nose of large bombers. Complete sets with indicator equipment, and power unit ready for installation

APS-6. 3 cm Night Fighter radar with pencil beam antenna. Transmitter-receiver packages and antennas available in equal to new condition.

APS-6A. 3 cm airborne radar RF package, 45kw, using 725A magnetron, 1F strip using 6AK5's, 723AB beacon and local oscillator.

ASP-10. 3 cm airborne radar using 2J42 magnetron. Modulator decks and low voltage power supply, only, available, less tubes. Beacon-local oscillator klystron mounts are available.

APQ-13. 3 cm airborne radar complete RF package in excellent condition including all tubes.

APS-15. 3 cm airborne radar designed for high altitude bombing, navigation, intercept of enemy aircraft weather forecasting. Antenna rotates 360 degrees. Presentation is PPI and A scope. The following units are supplied: Antenna, transmitter-receiver, modulator, indicator, slant-range computer, 24VDC input power unit. New with all tubes including 45kw 725A magnetron, 723AB local oscillator-beacon.

CPN-6. 3 cm Navigation Beacon ground station. Complete installation. High power coded beacon of latest JAN design. 115VAC input.

CPN-8. 10cm Navigation Beacon ground station. Complete and partial installations available. High power beacon of long range capability. Complete power, frequency, operation analyzer (5° scope) included.

CXBR. 10cm MIT navigation beacon equipment. Complete, in excellent condition.

FD & Mark IV. 800mc gunlaying radar mfg and designed by Western Electric for battleships. Complete consoles available with all tubes including 700A magnetron and modulator thyratron.

Mark 10. 10cm gunlaying radar, complete, for automatic firing of guns as antenna tracks target. 250 KW.

SA. 200mc Air Search radar especially designed for shipboard or mobile installation. Ideal for ground intercept and control of aircraft. PPI 7" indicator. Long range.

SD. 200mc radar similar to SA but designed for installation on submarines. New.

SE. 10cm shipboard Surface Search radar, using thyratron modulator. Complete installation available including spare parts. "A" scope presentation. 250 KW.

SF-1. 10cm shipboard Surface Search radar with PPI and A scope. Used for navigation and target range information on naval vessels. 250 KW.

SG. 10cm shipboard Surface Search radar with PPI and A scope. Heavy, rugged equipment designed for large naval and merchant vessels. 250 KW.

SJ-1. 10cm radar designed for installation on Submarines. Equipped with PPI and A scope. Complete installations.

SL. 10cm radar designed for Surface search on shipboard. PPI indicator console.

SN. 10cm portable radar. Lightweight, easily transportable complete radar installation using lighthouse tubes with a 25 mile maximum range. 115 VAC operation.

SO-1. 10cm shipboard radar for navigation on all types of vessels. 4, 20, and 80 mile range. PPI indicator. Large antenna. 115 VDC input.

SO-8. same as SO-1 but with a lightweight antenna.

SO-13. same as SO-1 but with lightweight antenna, 28VDC input. Designed for PT Boat installation.

SCR 518. Radar altimeter using pulse-echo-time principle, 400mc, 28 VDC input, CR tube altitude indication.

SCR 520. Airborne radar RF package, 10cm, complete with pulser, hard tube, 714AY magnetron.

SCR 533. IFF/Air Search trailer, complete, 500mc operation. A scope.

SCR 663. Sperry searchlight training, aircraft tracking ground installation. Used condition.

SQ. 10cm portable radar designed for use on landing barges and beach-heads. PPI, B, A indication on 3" scope. 115 VAC operation.

TPS-2. 1000mc Portable Early Warning System. Bedspring antenna. Complete with portable generator.

RT73/UPN-2. 10cm Portable Beacon Equipment.

TAJ. 500 Watt Low Frequency Transmitter, 150-550 KC, C.W., M.C.W.

TBK. 500 Watt High Frequency Transmitter 2 to 18 MC, A1, A2, A3. Emission. Mfg. by RCA.

RADIO SYSTEMS

White Radio Telephone Model #WRM55. Ship To Ship—Shore To Ship—Small Airports—Mines—Plantations—Inter-Island—Ranches. 10 channel Six Tuned Receiver & Transmitter XMTF Pair output in excess of 100W unmodulated into antenna of 18 & 100 MUF. Freq. Range 2-12 MC. Can be modified to increase range. Xtal controlled, 110V 60 Cy or 220V 60 or 25 Cy. Meas. 24" H x 19" W x 14" D. 125 lbs. Write or phone for data.

MICROWAVE TEST EQUIPMENT

THERMISTORS

D-167332 (tube) ...	\$1.50
D-170396 (tube) ...	\$1.50
D-167613 (outton) ...	\$1.50
D-164699 for MTG in "X" Band Guide \$2.50	
D-167018 (tube) ...	\$1.50

VARIATORS

D-170225	\$1.25
D-167176	\$1.50
D-168687	\$1.50
D-171812	\$1.50
D-171528	\$1.50
D-171528	\$1.50
D-168442	\$3.00
D-165593	\$1.25
D-98836	\$2.00
7-161871A	\$2.85
7-171121	\$1.50
D-98836	\$1.50
D-162356 (308A)	\$1.50
D-163357	\$2.00
D-99946	\$2.95

WRITE FOR
C.E.C. MICRO-
WAVE CATALOG
NOW AVAILABLE

23,000 to 27,000 mc. BENCH TEST PLUMBING—1/2" to 1/4" Waveguide

Precision Slotted Line, DeMornay Budd type 337	\$400.00
Complete with adjustable probe and crystal output. Square flanges	
Precision Slotted Line, Adjustable probe, Humble Oil type, C/PK-2111U	\$200.00
Directional Coupler-Wavemeter MIT, 121B	\$60.00
Precision Var Attenuator, mfg. Bernard Rice	\$90.00
Tunable Xtal Mt. DB423 less tuning plung.	\$30.00
Flap Attenuator, DB405 10DB attenuation	\$25.00
Low Power Load	\$25.00
Screw Tuner	\$25.00
Shunt Tee	\$35.00
Waveguide Lengths, 2" to 6" long, gold-plated with circular flanges and coupling nuts...	\$2.25 per inch
APS-34 Rotating Joint	\$49.50
Right Angle Bend E or H Plane, specify combination couplings desired	\$12.00
45° Bend E or H Plane, Choke to cover	\$12.00
Directional coupler CU-103/APS32	\$49.50
Mitered Elbow, cover to cover	\$4.00
TR-ATR Section, choke to cover	\$4.00
Flexible Section 1" choke to choke	\$5.00
Adapter, round to square cover	\$5.00
Feedback to Parabola Horn with pressurized wind	\$27.50
Low Power Load, less cards	\$18.50
K Band Mixer Block	\$45.00
Waveguide 1/2 x 1/4"	\$1.00 per ft.
Circular Flanges	50¢
Flange Coupling Nuts	50¢
Slotted Line, DeMornay-Budd #397, new	\$450.00
90° Twist	\$10.00
"K" Band Directional Coupler CUI04/APS-34	\$49.50
DB	\$115.00
K BAND 2K33 w/cav	\$55.00
3J31 Magnetrans	\$55.00

8500 Mc to 9600 Mc Bench Test Plumbing—1" x 1/2" Waveguide

Slotted Line, Complete with adjustable probe, crystal output, precision vernier adjust. Humble oil type \$220.00

Klystron Mount, DeMornay Budd type DB380 for 2K25, etc. Includes tunable termination... \$70.00

Variable Attenuator, DeMornay Budd type DB383, Maximum attenuation 35DB... \$120.00

Variable Stub Tuner, DB536, 180 degree phase shifting capability \$70.00

Flap Attenuator, DB385, Maximum Attenuation 10DB \$42.00

Magic Tee, DB539 \$42.00

Wave Guide to Type "N" Adapter, DB377 \$15.00

Low Power Termination, DB381... \$18.50

Uni-Directional Coupler, DB390, 23DB type "N" output \$18.50

Pick Up Horn, Type "N" output \$4.50

Wavemeter, 8500 to 9400 mcs. with calibration, Micrometer adjust head, Reaction type... \$85.00

Waveguide Lengths, plated and fitted with couplings available in 6", 12", 24", 30", 60" sections

90 Degree Elbows, E or H plane, 2 1/2" radius \$12.50

Mitered Elbows, E or H plane... \$10.00

45 Degree Offset Elbows, E or H plane... \$10.00

90 Degree Twist, 8" long... \$8.00

Bulkhead Feed-Thru Assembly... \$15.00

Pressure Gauge Section, 15 lb. gauge and pres. nipple \$10.00

Pressure Gauge, 15 lbs... \$2.50

Crystal Mount, 1N23 type crystal holder... \$17.50

6000 Mc. to 8500 Mc. Bench Test Plumbing 1 1/2" x 3/4" Waveguide

Dual Oscillator-Beacon Mount, P/O A1S10 Radar for mounting two 723A klystrons with crystal mts, matching slugs, shields... \$42.50

Dual Oscillator Mounts, (back to back) with crystal mount, tunable termination, attenuating slugs \$18.50

Directional Coupler, UG-40/U Take off 20 DB \$17.50

Directional coupler, APS-6 type "N" take off 20 DB calibrated \$17.50

Flexible Section 18" long... \$10.00

Rotary Joint Choke to Choke \$10.00

2K25/723 AB Receiver local oscillator Klystron Mount, complete with crystal mount, iris coupling and choke coupling to TR... \$22.50

TR-ATR Duplexer section for above... \$8.50

1 1/4" x 3/8" WAVEGUIDE

Slotted Line, Complete with adjustable probe, crystal output, precision vernier adjust. Humble Oil type \$225.00

Tunable Termination, Precision adjust... \$65.00

Low Power Termination... \$25.00

Magic Tee \$35.00

Transition, 1 1/4" x 3/8" to 1" x 3/8" \$19.50

Oscillator Mount, for four 723AB klystron \$38.50

90 Degree Elbows, E or H plane... \$12.50

Waveguide Lengths, Cut to size and supplied with 1 choke, 1 cover, per length... \$2.00 per ft.

Wavemeter, Absorption type, Precision micrometer adjust, Very high "Q" \$150.00

MAGNETRON MAGNETS

Gauss	Pole Diam.	Spacing	Price
4850	3/4 in.	3/8 in.	\$12.50
5200	11/32 in.	3/8 in.	\$17.50
1300	1 1/8 in.	1 1/8 in.	\$12.50
1860	1 1/8 in.	1 1/2 in.	\$14.50

Electromagnets for magnetrons... \$24.50 ea.

GE Magnets type M7765115, GI Distance Between pole faces variable, 2 1/16" (1900 Gauss) to 1 1/2" (2200 Gauss) Pole Dia. 1 1/2" New Part of SCR 584 \$34.50

MAGNETRONS

OK 61	2J32	2J61	720CY	
OK 60	2J37	2J62	725-A	
	2J21	2J38	3J31	730-A
	2J22	2J39	5J30	728
OK 815	2J26	2J40	714AY	700
OK 62	2J27	2J49	718DY	706
OK 58	2J31	2J34	720BY	

Klystrons 723A, 707B, 417A, 2K41



COUPLINGS—UG CONNECTORS

UG/15U	\$.75	UG 117 Choke	\$2.50
UG206U	.90	UG 51 Cover	1.35
UG87U	1.25	UG 52 Choke	1.00
UG27U	1.69	UG 210 Cover	1.85
UG21U	.89	UG 212 Choke	2.40
UG167U	2.25	3/8 Coax Female Ring	.50
UG29U	.90	3/8 Coax Male Fitting	.95
UG254U	1.69	X Band Circ. Choke	
UG86U	1.40	X Flange	.50
UG342U	3.25	X Band Flat Contact	
UG85U	1.45	Flange 1/4 Thk.	.25
UG58U	.60	Contact Ring 1/4" Thk	
UG9U	.89	1 1/2 dia. hole	.25
UG102U	.45	UG 53/U, Cover	4.00
UG103U	.45	UG 55/U, Cover	4.75
UG255U	1.65	UG 55/U, Cover	4.00
UG 40/U Spec. for Mixer Assy.	.75	UG 56/U, Choke	4.75
UG 40A	1.10	UG 65/U, Contact	6.50
UG 343 Cover	2.35	UG 149/U, Cover	3.00
UG 344 Choke	3.00	UG 148/U, Choke	4.00
UG 425 Contact	2.00	UG 150/U, Cover	3.00
UG 116 Cover & Coupl Ring	1.95	UG 39/U, Contact	.60
		UG 40/U, Choke	.80

Write us your needs.

4000 to 6000 mcs. Bench Test Plumbing 2" x 1" Waveguide

Slotted Line, DeMornay type 332 complete with probe, etc... \$600.00

Flap Attenuator... \$48.00

Variable Stub Tuner and Low Power Termination \$48.00

Wavemeter Tee... \$48.00

Adapters: Choke to choke... \$18.00
Cover to cover... \$14.00
Choke to cover... \$16.00

Waveguide to Type "N" Adapter... \$45.00

Directional Coupler, Two hole type, type "N" output \$48.00

Klystron Mount, Equipped with tunable termination and micrometer adjust, klystron antenna tuning... \$110.00

Crystal Mount, Equipped with tunable termination and micrometer adjust crystal tuning... \$125.00

Tunable Termination, Precision adjust... \$90.00

3000 MC. BENCH TEST PLUMBING

10 CM Wavemeter WE type 135-400 Transmission type, type N Fittings, Feeder Root, Micrometer dial, Gold Plated W/Calib. Chart P/O Pres. Meter X66404A, New \$99.50

AS14A/AP-10 CM Pick up Dipole with "N" Cables \$4.50

LHTR. LIGHTHOUSE ASSEMBLY, Part of RT39 APG 5 & APG 15, Receiver and Trans Cavities w/ assoc. Tr. Cavity and Type N CPLG. To Rev. Usee 2C40, 2C43, 1B27, Tunable APX 2400-2700 MCS, Silver Plated... \$49.50

Beacon Lighthouse cavity 10 cm with miniature 28 volt DC FM motor. Mfg. Bernard Rice. \$47.50 ea.

S. BAND

90° Twist, circular cover to circular cover... \$25.00

Magnetron to Waveguide Coupler with 721A Duplexer Cavity, gold-plated with tube and tuning plungers... \$45.00

721A TR Box complete with tube and tuning plungers... \$12.50

McNally Klystron Cavities for 707B or 2K28, Three types available... \$4.00

F-29/SPR-2 Filters, Type "N", input and output length \$12.50

726 Klystron Mount, Tunable output, to type "N" \$12.50

GENERAL TEST EQUIPMENT

Multi Frequency Generator, American Time Product type SC-16, Frequency 10 to 190, Precision Standard "Watch-Master" UHF Signal Generator, R.C.A. type 710A, 370 to 560 mcs.

Wheatstone Bridge, Industrial Inst. type RN-1, FM Signal Generator, Beconton Radio type 155A, Freq. range 1 to 10 mcs. 38 to 50 mcs.

Condenser Weld Power, Cap. 36 mfd. max., max. chr. 1500 Volts.

Frequency Meter, Lavote Model 105-300 to 600 mcs. Mogohm Bridge, Industrial Instruments type MB, Visual Alignment Signal Generator, General Electric—0 to 60 mcs.

NEW TEST EQUIP. IN STOCK

1-185A Oscillator	Write
1-158 Range Calibrator	or
1-233 Range Calibrator	Phone
BC 438 Freq. Meter	
RF Preamp.	
G.R. Capacity Brdg #216	for
G.R. Uni Galvo Shunt #229	Data
G.R. 1000 Ad. Osc. #213	and
TS 226A/AP Pwr. Mtr. 0-1000W.	Price
Sig Gen #804 B-330 MC	

PULSE EQUIPMENT

G.E.K.—2745	\$39.50
G.E.K.—2744-A	11.5 KV High Voltage, 3.2 KV Low Voltage @ 20 KV oper. (270 KW max.) 1 microsec. or 1/2 microsec. @ 600 PPS. \$39.50
G. E. K2450A	Will receive 13 KV 4 microsec. on pulse on pri. secondary delivers 14KV. Peak power out 100KW G. E.
TPS10 Modulator X Band	\$350.00
SO-4 Thyatron Modulator	\$600.00
SCR-268 Keyer units	\$95.00
715B Tubes	1.00
705A Tubes	\$2.85
705 Sockets	.70¢

Complete line of high voltage pulse transformers, networks and dual lines.

ARMY-NAVY TEST SETS

TS-45/APM—3 cm Signal Generator.	
TS-226A/AP Pwr Meter.	
TS62/AP 3 centimeter precision echo box.	
TS36/AP 3 centimeter Thermistor Bridge—Power Meter.	
TS89/AP Voltage divider.	
TS268/AP Crystal checker for 1N23 type crystals etc.	
CW-60ABM 10 Centimeter Wavemeter. Coaxial type micrometer adjust cavity, Resonance indicating meter, carrying case (similar to TS117/G).	
TS235/UP High Power Load, "L" band (100 mcs.)	
LU-1 FREQ. Meter and Test Oscillator. Type CRV-60ACL.	
TVN-9HU POWER SUPPLY, MIT Rad. Lab.	

COMMUNICATIONS EQUIPMENT CO.

131 Liberty St., New York, N. Y. Dept. E-10 P. J. PLISHNER Phone: Digby 9-4124

**FULLY
GUARANTEED**

BRAND NEW SURPLUS OFFERED BY A LEADING

A.C. MOTORS

5071930, Delco, 115 V., 60 Cycle, 7000 r.p.m. **Price \$4.50 each net.**
36938-2, Haydon Timing Motor, 110 V., 60 cycle, 2.2 w., 4/5 r.p.m. **Price \$3.00 ea. net.**

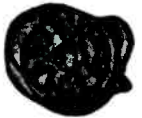

Type 1600 Haydon Timing Motor—110 V., 60 cycle, 3.2 w., 4 r.p.m., with brake **Price \$4.00 each net.**
Type 1600 Haydon Timing Motor—110 V., 60 cycle, 2.2 w., 1/240 r.p.m. **Price \$3.00 each net.**

Type 1600 Haydon Timing Motor 110 V., 60 cycle, 2.3 w., 1 r.p.m. **Price \$2.70 each net.**

Type 1600 Haydon Timing Motor, 110 V., 60 cycle, 2.2 w., 1 1/5 r.p.m. **Price \$2.70 each net.**

Type 1600 Haydon Timing Motor 110 V., 60 cycle, 3.5 w., 1 r.p.m. With shift unit for automatic engaging and disengaging of gears. **Price \$3.30 each net.**

Type 1600 Haydon Timing Motor, 110 V., 60 cycle, 2.2 w., 1/60 r.p.m. **Price \$3.00 each net.**

Eastern Air Devices Type J33 Synchronous Motor 115 V., 400 cycle, 3 phase, 8,000 r.p.m. **Price \$8.50 each net**

Telechron Synchronous Motor, Type B3, 115 V., 60 cycle, 2 r.p.m., 4 w. **Price \$5.00 each net.**

Barber-Colman Control Motor, Type AYLC 5091, reversible 24 volts D.C. .7 amps 1 R.P.M., Torque 500 in. lbs. Contains 2 adjustable limit switches with contacts for position indication. Ideal for use as a remote positioner or a beam or television antenna rotator, will operate on A.C. 60 cycle. **Price \$6.50 each net**

SERVO MOTORS

CK 1, Pioneer, 2 phase, 400 cycle. **Price \$10.00 each net.**

CK 2 Pioneer, 2 phase, 400 cycle. **Price \$4.25 each net**

10047-2-A Pioneer 2 phase, 400 cycle, with 40:1 reduction gear. **Price \$7.25 each net.**

FPE-25-16 Diehl Low-Inertia 20 V., 60 cycle, 2 phase, 1600 r.p.m., 85 amps. **Price \$10.00 each net.**

CK2, Pioneer, 2 phase, 400 cycle, with 40:1 reduction gear. **Price \$6.50 each net.**

CK5 Pioneer, 2 phase, 400 cycle. **Price \$20.00 ea. net.**

MINNEAPOLIS-HONEYWELL TYPE B Part No. G303AY, 115 V., 400 cycle, 2 phase, built-in gear reduction, 50 lbs. in torque. **Price \$10.00 each net.**

Kollsman Type 776-01 400 cycle 2 phase drag-up type, fix phase voltage 29, variable phase 35V. maximum, frequency 400 cycle. **Price \$10.50 each net.**

REMOTE INDICATING MAGNESYN COMPASS SET
Pioneer Type AN5730-2 Indicator and **AN5730-3** Transmitter 26 V., 400 cycle. **Price \$40.00 per set new sealed boxes.**



Kollsman Remote Indicating Compass Set Transmitter part No. 679-01, indicator part No. 680k-03, 26 V., 400 cycle. **Price \$12.50 each net.**

GYROS

Schwein Free & Rate Gyro type 45600. Consists of two 28 V. D.C. constant speed gyros. Size 8" x 4.25" x 4.25". **Price \$15.00 ea. net.**



Sperry A5 Directional Gyro, Part No. 656029, 115 volts, 400 cycle, 3 phase. **Price \$17.50 each net.**



Sperry A5 Vertical Gyro, Part No. 644841, 115 V., 400 cycle, 3 phase. **Price \$20.00 each net.**

Sperry A5 Amplifier Rack Part No. 644890. Contains Weston Frequency Meter. 350 to 450 cycle and 400 cycle, 0 to 130 voltmeter. **Price \$10.00 each net.**

Sperry A5 Control Unit Part No. 644836. **Price \$7.50 each net.**

Sperry A5 Azimuth Follow-Up Amplifier Part No. 656030. With tube. **Price \$5.50 each net.**

Sperry A5 Autopilot Indicator: contains Pioneer AY20 Autosyn 26 V., 400 cycle. **Price \$9.50 ea. net.**

Pioneer Type 12800-1-D Gyro Servo Unit. 115 V., 400 cycle, 3 phase. **Price \$10.00 each net.**

Norden Type M7 Vertical Gyro. 26 V., D.C. **Price \$19.00 each net.**

Allen Calculator, Type C1 Bank and Turn Indicator, Part No. 21500, 28 V. D.C. Contains 28 V. D.C. constant speed gyro. **Price \$10.00 each net.**

Type C1 auto-pilot formation stick, part No. G1080A3. **Price \$15.00 each net.**

GOVERNMENT approved instrument repair station No. 3564.

D.C. MOTORS



5069625, Delco Constant Speed, 27 V., 120 r.p.m. Built-in reduction gears and governor. **Price \$4.50 each net.**
A-1755, Delco Constant Speed Shunt Motor, 27 V., 2.4 amps., 3600 r.p.m., 1/30 h.p. Built-in governor. **Price \$6.25 each net.**

C-28P-1A, John Oster Series Motor, 27 V., 0.7 amps., 7000 r.p.m., 1/100 h.p. **Price \$4.50 each net.**

Jaeger Watch Co. Type 44-K-2 Contactor Motor, Operates on 3 to 4.5 volts D.C. Makes one contact per second. **Price \$2.00 each net.**

General Electric Type 5BA10AJ52C, 27 V. D.C., 0.65 amps., 14 oz. n. torque, 145 r.p.m. Shunt Wound, 4 lead reversible. **Price \$5.00 each net.**

General Electric Type 5BA10AJ37C, 27 V.D.C., 0.5 amps., 8 oz., in. torque, 250 r.p.m. Shunt Wound, 4 leads reversible. **Price \$6.50 each net.**

General Electric Type 5BA10J18D, 27 V. 0.7 amps. 110 R.P.M. 1 oz. ft. torque. **Price \$4.75 ea. net.**

D.C. ALNICO FIELD MOTORS

S. S. FD6-16, Diehl, 27 V., 10,000 r.p.m. **Price \$4.50 each net.**

S. S. FD6-18, Diehl, 27 V., 10,000 r.p.m. **Price \$4.50 each net.**

S. S. FD6-21, Diehl, 27 V., 10,000 r.p.m. **Price \$4.50 each net.**

5069600 Delco 27.5 V. 250 R.P.M. **Price \$10.00 each net.**

706343 Delco 27.5 V. 10,000 R.P.M. Shaft 0.5 in. long. **Price \$7.50 ea. net.**

5068571 Delco 27.5 V. 10,000 R.P.M. with blower assembly. **Price \$10.00 ea. net.**

5071895 Delco 27.5 V. 250 R.P.M. **Price \$10.00 ea. net.**

5072400 Delco 27.5 V. 10,000 R.P.M. Shaft 0.5 in. long with worm gear. **Price \$6.75 ea. net.**

GENERAL ELECTRIC D. C. SELSYNS



8TJ9-PDN Transmitter, 24 V. **Price \$3.75 each net.**

8TJ9-PAB Transmitter 24V. **Price \$3.75 each net.**

8DJ11-PCY Indicator, 24 V. Dial marked -10° to +65°. **Price \$4.50 each net.**

8DJ11-PCY Indicator, 24 V. Dial Marked 0 to 360°. **Price \$7.50 each net.**

AMPLIFIER

Pioneer Gyro Flux Gate Amplifier, Type 12076-1-A. **Price \$17.50 ea. net, with tubes.**

G. E. Servo Amplifier Type 2CV1C1, 115 V. 400 cycle. **Price \$9.00 ea. net.**

Minneapolis Honeywell Amplifier Type G403, 115 V. 400 cycle. **Price \$8.00**

INSTRUMENT ASSOCIATES

37 EAST BAYVIEW AVE., GREAT NECK, N. Y. Telephone Great Neck 4-1147

Write for Catalog NE100

U. S. Export License-2140

SUPPLIER OF ELECTRONIC & AIRCRAFT EQUIPMENT**IMMEDIATE
DELIVERY****INVERTERS**

Wincharger Corp. Inverter PU/16 type MG 750, Input 24 V.D.C., 60 amps. Output 115 V., 400 cycle, 1 phase, 6.5 amps. **Price \$60.00 each net.**

153F, Holtzer Cabot, Input, 24 V.D.C. Output 115 V., 400 cycle, 3 phase, 750 V.A. and 26 V., 400 cycle, 1 phase, 250 V.A. Voltage and frequency regulated also built in radio filter.



Price \$115.00 each net.

149H, Holtzer Cabot. Input 28 V. at 44 amps. Output 26 V. at 250 V.A., 400 cycle and 115 V. at 500 V.A., 400 cycle. **Price \$40.00 each net.**

149F, Holtzer Cabot. Input 28 V. at 36 amps. Output 26 V. at 250 V.A., 400 cycle and 115 V. at 500 V.A., 400 cycle. **Price \$40.00 each net.**

12117, Pioneer. Input 12 V.D.C. Output 26 V., 400 cycle, 6 V.A. **Price \$22.50 each net.**

12117-2 Pioneer. Input 24 V.D.C. Output 26 V. 400 cycle, 6 V.A. **Price \$20.00 each net.**

12116-2-A Pioneer. Input 24 volts D.C., 5 amps. Output 115 volts 400 cycle single phase 45 watts. **Price \$100.00 each net.**

5D21NJ3A General Electric. Input 24 V.D.C. Output 115 V., 400 cycle at 485 V.A. **Price \$15.00 each net.**

PE 218, Ballentine. Input 28 V.D.C. at 90 amps. Output 115 V., 400 cycle at 1.5 K.V.A. **Price \$50.00 each net.**

METERS

Weston Frequency Meter, Model 637, 350 to 450 cycles, 115 volts. **Price \$10.00 each net.**

Weston Voltmeter, Model 833, 0 to 130 volts, 400 cycle. **Price \$4.00 each net.**

Weston Voltmeter, Model 606, Type 204 P, 0 to 30 volts D.C. **Price \$4.25 each net.**

Weston Ammeter, Model 506, Type S-61209, 20-0 100 amps. D. C. **Price \$7.50 each net with ext. shunt.**

Weston Ammeter, Type F1, Dwg. No. 116465, 0 to 150 amps. D. C. **Price \$6.00 each net. With ext. shunt \$9.00 each net.**

Westinghouse Ammeter, Type 1090-D-120, 120-0-120 amp. D. C. **Price \$4.50 each net.**

Weston Model 54S, Type 82PE Indicator. Calibrated 0 to 3000 RPM. 2 3/4" size. Has built-in rectifier, 270° meter movement. **Price \$15.00 each net.**

RECTIFIER POWER SUPPLY

General Electric, Input 230 V. 60 cycle 3 phase. Output 130 amps. at 28 V. D.C. Continuous duty, fan cooled, has adjustable input taps. G.E. model No. 6RC146F. Size: Height 46", width 28", depth 17 1/2". **Price \$200.00 each net. New**

PIONEER AUTOSYNS

AY1, 26 V., 400 cycle.

Price \$5.50 each net.

AY14D, 26 V., 400 cycle, new with calibration curve.

Price \$15.00 each net.

AY20, 26 V., 400 cycle.

Price \$7.50 each net.



AY5, 26V., 400 cycle. Has hollow shaft.

Price \$7.50 ea. net.

PRECISION AUTOSYNS

AY101D, new with calibration curve.



PRICE—WRITE OR CALL FOR SPECIAL QUANTITY PRICES

AY131D, new with calibration curve.

Price \$35.00 each net.

AY201-2-A. Price \$35.00 each net.

PIONEER AUTOSYN POSITION INDICATORS

Type 5907-17. Dial graduated 0 to 360°, 26 V., 400 cycle.

Price \$15.50 each net.

Type 6007-39, Dual, Dial graduated 0 to 360°, 26 V., 400 cycle.

Price \$30.00 each net.

PIONEER TORQUE UNIT

Type 12602-1-A.

Price \$40.00 each net.



Type 12606-1-A. Price \$40.00 each net.

Type 12627-1-A. Price \$80.00 each net.

MAGNETIC AMPLIFIER ASSEMBLY

Pioneer Magnetic Amplifier Assembly Saturable Reactor type output transformer. Designed to supply one phase of 400 cycle servo motor.

Price \$8.50 each net.

PIONEER TORQUE UNIT AMPLIFIER

Type 12073-1-A, 5 tube amplifier, Magnesian input, 115 V., 400 cycle.

Price \$17.50 each net with tubes.

ALL PRICES,
F. O. B.
GREAT NECK,
N. Y.

**BLOWER ASSEMBLY
MX-215/APG**

John Oster, 28 V.D.C., 7000 r.p.m. 1/100 h.p. Price \$4.50 each net.

Westinghouse Type FL Blower, 115 V., 400 cycle, 6700 r.p.m., Airflow 17 C.F.M. Price \$3.70 each net.

RATE GENERATORS

F16, Electric Indicator Co., two-phase, 22 V. per phase at 1800 r.p.m.

Price \$12.00 each net.

J36A, Eastern Air Devices, .02 V. per r.p.m. Price \$9.00 each net.

B-68, Electric Indicator Co., Rotation Indicator, 110 V., 60 cycle, 1 phase. Price \$14.00 each net.

PM-1-M Electric Indicator Co. Same as type B35. 2 V. per 100 R.P.M. Max. speed 5,000 R.P.M. Can be used as D.C. motor, 1/77 H.P. 115 V. D.C. Price \$9.75 ea. net.

SINE-COSINE GENERATORS

(Resolvers)

FPE 43-1, Diehl, 115 V., 400 cycle.

Price \$20.00 each net.

SYNCHROS

1F Special Repeater, 115 V., 400 cycle. Will operate on 60 cycle at reduced voltage.

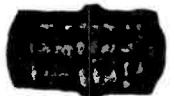

Price \$15.00 each net.

7G Generator, 115 V., 60 cycle.

Price \$30.00 each net.

2J1F3 Selsyn Generator 115 volts, 400 cycle. Price \$5.50 each net.

2J1M1 Control Transformer 105/63 V., 60 cycle. Price \$20.00 each net.

2J1G1 Control Transformer, 57.5/57.5 V., 400 cycle. Price \$1.90 each net.

2J1H1 Selsyn Differential Generator, 57.5/57.5 V., 400 cycle.

Price \$3.25 each net.

W. E. KS-5950-L2, Size 5 Generator, 115 V., 400 cycle.

Price \$10.00 each net.

5G Generator 115 volts, 60 cycle.

Price \$50.00 each net.

5SF Repeater, 115/90 V., 400 cycle.

Price \$19.00 each net.

2J1F1 Selsyn Generator, 115 V., 400 cycle. Price \$3.50 each net.

5SDG Differential Generator 90/90 V., 400 cycle. Price \$12.00 each net.

1CT Control Transformer, 90/55 volts, 60 cycle. Price \$40.00 each net.

POSITION TRANSMITTER

Pioneer Type 4550-2-A Position Transmitter, 26 volts 400 cycle, gear ratio 2:1. Price \$15.00 each net.

**INSTRUMENT
ASSOCIATES**

37 EAST BAYVIEW AVE., GREAT NECK, N. Y.
Telephone Great Neck 4-1147

Write for Catalog NE100

Western Union address:
WUX Great Neck, N. Y.

**MOTOR GENERATORS
DYNAMOTORS, INVERTERS, ETC.**

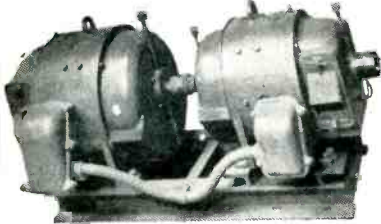

2.5 KVA MG SET. Diehl Elec. Co. 120V DC to 120V AC, 60 cy, 1 Ph. Complete with Magnetic Controller, 2 Field Rheos and Full Set of Spare Parts including Spare Armatures for Generator and Motor. Full specs. on request. New. **\$285.00**

2 KVA MG SET. O'Keefe and Merritt. 115V DC to 120V AC, 50 cy. Idles as 3 Ph. syncs motor on 208V, 50 cy. New. Export crated **\$165.00**

1.25 KVA MG SET. Allis-Chalmers. 115V DC to 120V AC, 50 cy. Fully enclosed. Splashproof. Ball Bearings. New. **\$97.50**
Same machine but for 230V DC operation. **\$110.00**

Spare Parts for either machine. **\$15.00**

MG SET FOR NAVY TBS TRANSMITTER. Type CG-21302. 440V AC, 60 cy, 3 Ph, 1500 VA to 875V DC and 300V DC. New. **\$69.50**

DYNAMOTOR. Navy Type CAJO-211444. 105/130V-DC to 13V DC at 40A or 26V DC at 20A. Radio filtered. Complete with Line Switch. New. **\$69.50**

DYNAMOTOR. Eacor. 32V DC to 110V AC, 60 cy, 1 Ph. 2.04 Amps. New. **\$24.50**

DYNAMOTOR. Eacor. 32V DC to 110V AC, 60 cy, 1 Ph, 0.43 Amps. New. **\$17.50**

AMPLIDYNE—G. E. Model 5AM31NJ9A. 530 Watts. 7500 R.P.M. Input: 27V DC, Output: 60V DC. Weight 34½ lbs. New. **\$10.50**

AMPLIDYNE—G. E. Model 5AM21J17. 4600 R.P.M. Motor Compound wound. 150 Watts. Input: 27V DC, Output: 60V DC Sig. Corps. U. S. Army MG-27-B. New. **\$26.50**

INVERTER—Leland Elec. Co. Model PE206A. Input: 28V DC, 38 Amps. Output: 80V, 800 cy, 485 VA. New. **\$12.50**

INVERTER—G. E. Model 5D-21N33A. Input: 24V DC, Output: 115V, 400 cy, 485 VA. New. **\$12.50**

PE 218 INVERTER—G. E. J8169172. Input: 28V DC, Output: 115V, 400 cycles at 1.5 KVA. **\$50.00**

D. C. MOTOR—G. E. Model 5HA 50LJ2A. 0.5 HP. Armature: 27V, at 8.3 Amps. Field: 60V, at 2.3 Amps. R.P.M. 400. New. **\$12.50**

DYNAMOTOR—Type PE91C. For use with SCR522 Transmitter-Receiver. Brand new in export cases **\$9.50**

**U. S. NAVY
SOUND POWERED BATTLE
PHONES**

Western Electric No. D173312. Type O. Combination headset and chest microphone as illustrated. Brand new including 20 ft. of rubber covered cable. **\$17.50**



Automatic Elec. Co. No. GL843A0. Similar to above but including Throat microphone in addition to chest microphone. Brand new with 20 ft. rubber covered cable. **\$13.50**

**SYNCHRO
GENERATORS**



Brand new—Gov't. sealed and inspected—Packed in overseas cans. Synchro Transmitters 115 V., 60 cy. operation. Precision accuracy made for gun fire control. Cost Gov't \$90.00 each. Wgt. 5 lbs. Dimensions: 4½" L x 3¼" D. Brand New **\$17.50** Per Pair

S. G. RADAR EQUIPMENT

Navy Yard Spares for
Model SG Radar

Consisting of the following:

- 2—CRP-20ABM Rectifier Power Units for modulation generators.
- 2—CRP-20ABM Rectifier Power Units for Radar Receivers.
- 2—CRP-35AAM Modulation Generators.
- 2—CRP-46A1D-1 Radar Receivers (including R-506 Gain Controls for Range and Train Indicators).
- 2—CRP-60AAN Signal Monitors.
- 2—Complete Transmitter R.F. System coupling assemblies including—10087 magnets and Duplexing tube cavity assemblies.
- 1—Complete Power Control Chassis.
- 2—Complete Driver and modulator assembly including driver chassis with delay line, Modulator and Driver Rectifier Tube Assembly and Driver Rectifier Power Unit.
- 2—Complete sets of equipment spare part consisting of R.F. Assemblies, motors and accessories, switches, interlocks, fuses, fuse holders, fuse links, relays, contacts, crystals, thermostats, R.F. inductors, capacitors, sockets, test equipment, cables, resistors, etc., as listed in Navy Spare Parts List WX3885.

All above in new and unused condition packed in original metal spare parts boxes.

RADAR COMPONENTS

- CRP-23AGC Load Dividers for use with S.G. Modernization Kits. New.
- CIM-50AFO Navy type Radar Repeater Adapters. New and complete with 14 tubes, coax fittings, installation plans and wiring diagram.
- Synchro Amplifiers. New.
- Type CARD 23AEK Bearing Control Units. New.
- Type T.D.Y., SO-1, SO-13, SO-3 Radar Antenna Assemblies. New.
- Radar Crystals Raytheon 98 35 KC.
- Type SO-11 Radar Modulator.
- Type SO-1 Transmitter Receivers.

**MODEL AN/APA-10
PANORAMIC ADAPTER**

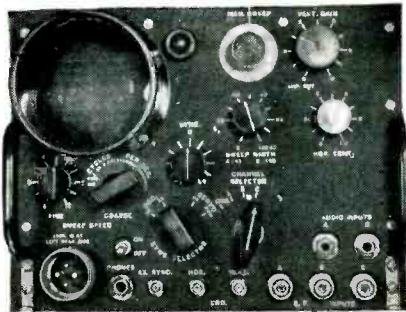

Provides 4 Types of Presentation:
(1) Panoramic (2) Aural
(3) Oscillographic (4) Oscilloscopic

Designed for use with receiving equipment AN/ARR-7, AN/ARR-5, AN/APR-4, SCR-587 or any receiver with I.F. of 455kc, 5.2mc, or 30mc. With 2 tubes including 3" scope tube. Converted for operation on 115 V, 60 cycle source.
PRICE \$245.00
AN/APA-10 80 Page Tech Manual. **\$2.75**

MICROWAVE TUNING UNITS

Tuning Units for APR-1 or APR-4, TN-16 (38-95 mc.) TN-17 (74-320 mc) TN-18 (300-1000 mc.) These front ends may be used with any 30 mc. IF amplifier or as converters into receivers tuned to 30 mc.

**LINEAR SAWTOOTH
POTENTIOMETER**



W.E. KS-15138
has continuous resistance winding to which 24 volts D.C. is fed to two fixed taps 180° apart. Two rotating brushes 180° apart take off linear sawtooth wave voltage at output.
Brand New \$5.50

**LAVOIE FREQ. METER
MICRO-WAVE**

375 to 725 MCS

Model TS-127/U is a compact, self-contained, precision (± 1 MC) frequency meter which provides quick, accurate readings. Requires a standard 1.5V "A" and 45V "B" battery. Has 0-15 minute time switch. Contains sturdily constructed III-"Q" resonator with average "Q" of 3000 working directly into detector tube. Uses 957, LS6 and 384 Tubes. Complete, new with inst. book, probe and spare kit of tubes. Less batteries. Write for descriptive circular. **\$69.50**

RAYTHEON VOLTAGE REGULATOR

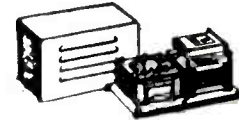

Adj. Input taps 95-130V., 60 cy. 1 Ph Output: 115V., 60 Watts, ¼ of 1% Reg. Wt. 20 lbs. 6¼" H x 8¼" L x 4¾" W. Overload protected. Sturdily constructed. Tropicalized.
Special. **\$14.75**

400 CYCLE TRANSFORMERS

- AUTO. 400 cy. G.E. Cat. No. 80G184 KVA .945S—520P. Volts 400/345/230/115. New **\$3.45**
- FILAMENT. 400/2600 cy. Input: 0.75/80/85/105/115/125V. Output: 5V3A/5V3A/5V3A/5V3A/5V6A/5V6A/6.3V6A/6.35A. New **\$1.95**
- THYRATRON POWER. 400/1600 cy. Raytheon UX-8876. 400/1600 cy. Pri: 115V. Sec: 50-0-50V at 0.5A. 6.3V at 1.2A. Test r.m.s. 1780. New **\$2.75**
- PLATE WECO KS9560. 400/800 cy. Pri: 115V. Sec: 1350-0-1350 at .057A (2700 V Total). Electrostat shielded. Wt. 2.3 lbs. New. **\$2.95**
- SCOPE PL. & FIL. WECO 9556. 400/2400 cy. Pri: 115. HV. Wdg. 1125V at .008A. P.I. Wdgs. 6.4V4A/2.5V1.75A/6.4V.6A. Electrostat shielded. Wt. 1.4 lbs. New. **\$2.75**
- FILAMENT. 400/2400 cps. WECO KS9553. Pri: 115V. Sec: 8.2V1.25A/6.35V1.5A. Electrostat shielded. Wt. 0.5 lbs. New. **\$1.65**
- PLATE & FIL. 400/2600 cy. Pri: 0/80/115V. Sec #1=1200VDC at 1.5MA. Sec#2=400VDC at 130MA. Fil. Secs: 6.4V4.3A/6.35V0.8A. (Ans. 1500V)/5V2A/5V2A. **\$3.95**
- RETARD. 400 cy. WECO KS9598. 4 Henry 100MA. **\$1.00**

400 CY. SERVO TRANSFORMERS

- G.E. #68G665X Pri: 57.5V. Sec: #1=28.75V. Sec: #2=28.75V. **\$1.50**
- G.E. #68G666X Pri: 57.5V. Sec: 115V C.T. **\$1.50**
- G.E. #68G667 Pri: 220V C.T. Sec: 220V C.T. **\$1.50**
- G.E. #68G668X Pri: 115V. Sec: 275V/275V/275V/230V/230V/6.3V C.T./6.3V C.T. **\$3.50**

60 CYCLE TRANSFORMERS

- 1.5 KVA STEPDOWN. G.E. Cat. No. 76G173. Pri: 115/230V Sec: 23/11.5V. Either high voltage connection may be used with either low voltage connection. **\$23.95**
- 50KVA STEPDOWN. Standard Trans Corp. trans type MD. Pri: 450V111A. Sec: 117V42A. Navy type. Ambient temp. 50 Deg. C. **\$125.00**
- FILAMENT. Raytheon Hypersil Core. Pri: 115V. Sec: 6.3V2.2A/6.3V2.4A/6.3V2.25A/6.3V0.6A. Ins. for 1700V. **\$3.95**

PULSE TRANSFORMER

PULSE. WECO KS-9563. Supplies voltage peaks of 3500V from 807 tube. Tested at 2000 Pulses/sec and 5000V peak. Wdg. 1-2=18 ohms. Wdg. 1-3=72 ohms. L of Wdg. 1-3=.073-.082H at 100 cps **\$5.50**

**High Voltage Capacitors
Oil Filled**

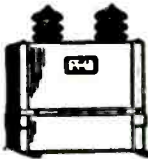

- .25 MFD., 20KV **\$17.75**
- .25 MFD., 15KV **\$15.75**
- .5 MFD., 25KV **\$26.50**
- 1 MFD., 15KV **\$18.50**
- 1 MFD., 7.5KV **\$7.95**

All brand new. Made by prominent manufacturers.

**SWEEP GENERATOR
CAPACITOR**

High speed ball bearings. Split stator silver plated coaxial type 5/10 mmfd. Brand new. **\$2.50**



PARABOLOIDS

Span Magnesium dishes 17½" dia., 4" deep. Mounting brackets for elevation and azimuth control on rear. 1½" x 1½" opening in center for dipole. Brand new per pair. **\$8.75**

All prices indicated are F O B Tuckahoe, New York. Shipments will be made via Railway Express unless other instructions issued.

ELECTRONICRAFT

INC.

5 WAVERLY PLACE TUCKAHOE 7, N. Y.
PHONE: TUCKAHOE 3-0044

All merchandise guaranteed. Immediate delivery, subject to prior sale.

All Prices Subject to Change Without Notice

SAVE on Miniature and Toggle Switches at WELLS

Miniature Switches

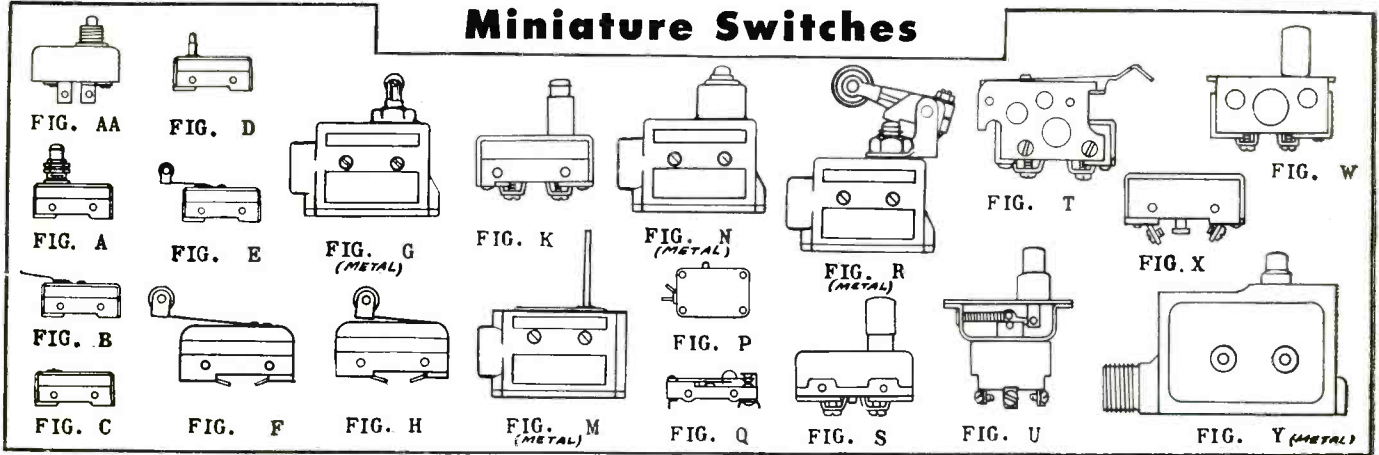

STOCK NUMBER	MANUFACTURER	MFR. TYPE NO.	CONTACTS	ILLUSTRATION	PRICE EACH	STOCK NUMBER	MANUFACTURER	MFR. TYPE NO.	CONTACTS	ILLUSTRATION	PRICE EACH
305-10	Microswitch	WP3M5	N.C.	FIG. AA	\$0.40	PH-111	Microswitch	GRS	N.O.	FIG. D	\$0.49
305-160	Microswitch	WP-5M3	N.C.	FIG. AA	.40	311-116	Microswitch	SW-186	N.C.	FIG. D	.63
307-210	Microswitch	Y2P3A	N.O.	FIG. AA	.50	303-49	Microswitch	Y22YST	SPDT	FIG. D	.68
303-67	Microswitch	Y27RA6	N.O.	FIG. A	.71	309-93	Microswitch	BRS36	SPDT	FIG. D	.68
PH-100	Acro	R0182T	N.O.	FIG. A	.71	370-17	Microswitch	QRS	SPDT	FIG. D	.75
301-46	Acro	MLB-321	SPDT	FIG. B	.85	PH-112	Microswitch	MBW	SPDT	FIG. E	.72
301-93	Microswitch	YZ-2YLTC1	SPDT	FIG. B	1.01	311-25	Microswitch	CUN24155	N.C.	FIG. E	.85
301-30	Microswitch	R02M	SPDT	FIG. B	.95	370-10	Microswitch	R02M12T	N.O.	FIG. E	.70
301-78	Microswitch	Green Dot	SPDT	FIG. B	.75	303-32	Microswitch	YZ-3RW2T	N.O.	FIG. F	.65
303-79	Microswitch	BZ-RL32	SPDT	FIG. B	.75	306-10	Microswitch	BZE-2RQ9TM1	SPDT	FIG. G	2.48
303-85	Microswitch	MLB329	SPDT	FIG. B	.67	PH-120	Microswitch	YZ7RQ9T6	N.O.	FIG. G	.75
305-154	Microswitch	XD4-5L	SPDT	FIG. B	.78	309-101	Microswitch	BZ-2FW221	SPDT	FIG. H	.95
311-130	Microswitch	—	SPDT	FIG. B	.70	PH-113	Microswitch	RZBQT	SPDT	FIG. K	.58
PH-101	Microswitch	BRL18	SPDT	FIG. B	.78	L306-1010	Microswitch	R07-8586	N.O.	FIG. K	.55
PH-102	Microswitch	YZRL812	N.O.	FIG. B	.65	370-18	Microswitch	HR071P2TSF1	N.O.	FIG. K	.60
PH-104	Microswitch	YZ3RLTC2	N.O.	FIG. B	.64	370-19	Microswitch	YZRQ41	N.O.	FIG. K	.65
PH-105	Microswitch	YZR31	N.O.	FIG. C	.53	370-8	Microswitch	RN-11-H03	SPDT	FIG. M	1.50
PH-106	Microswitch	R-R36	N.C.	FIG. C	.50	309-157	Microswitch	—	N.C.	FIG. N	1.15
PH-107	Microswitch	BR-26	N.C.	FIG. C	.53	370-15	Microswitch	AHB203	SPDT	FIG. N	1.25
PH-108	Microswitch	WZ-2RT	N.C.	FIG. C	.50	370-7	Microswitch	WZE-7RQTN	N.C.	FIG. N	1.35
305-161	Microswitch	YZ3R3	N.O.	FIG. C	.71	305-11	Microswitch	2M031A	N.O.	FIG. P	.37
311-115	Microswitch	WZR31	N.C.	FIG. C	.71	305-50	Microswitch	Open Type	SPDT	FIG. Q	.35
311-123	Microswitch	WZ-7R	N.C.	FIG. C	.60	303-84	Microswitch	HR07-4PST	N.O.	FIG. S	.50
311-126	Microswitch	HRRC7.1A	N.C.	FIG. C	.50	303-83	Microswitch	YZ-RQ4	N.O.	FIG. S	.50
311-125	Microswitch	HRR07.1A	N.O.	FIG. C	.53	PH-114	Microswitch	WZR-31	N.C.	FIG. T	.65
311-121	Microswitch	WZ7RTC	N.C.	FIG. C	.50	PH-115	Cutler Hammer	8905K564	DPDT	FIG. U	.65
311-128B	Microswitch	YZ	N.O.	FIG. C	.53	PH-116	Microswitch	WZRQ41	N.O.	FIG. W	.60
370-6	Microswitch	X757	N.C.	FIG. C	.45	PH-118	Microswitch	BZRQ41	SPDT	FIG. W	.60
PH-119	Microswitch	WZR-8X	N.C.	FIG. C	.45	311-128A	Microswitch	YZ-RTX1	N.O.	FIG. X	.90
PH-109	Microswitch	RRS13	N.C.	FIG. D	.45	PH-117	Microswitch	Z	N.C.	FIG. Y	1.35
PH-110	Microswitch	BRS36	SPDT	FIG. D	.53						

Toggle and Push Switches

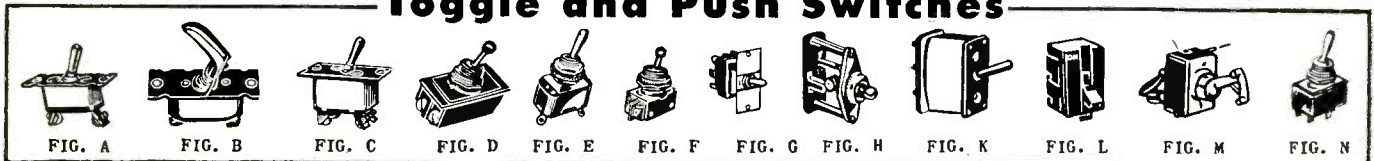

STOCK NUMBER	FIG.	CONTACT ARRANGEMENT	MANUFACTURER & NUMBER	PRICE EACH	STOCK NUMBER	FIG.	CONTACT ARRANGEMENT	MANUFACTURER & NUMBER	PRICE EACH
PH-500	A	SPDT	B1B	\$0.35	305-174	C	DPDT CENTER OFF MOM 1 SIDE	AN-3023-5	\$0.50
PH-501	A	SPDT	AN3022-3B	.35	305-177	C	DPDT CENTER OFF MOM EACH SIDE	C-3	.50
PH-503	A	SPDT CENTER OFF MOM EACH SIDE	B11	.32	305-176	C	DPDT CENTER OFF MOM EACH SIDE	AN-3023-7	.50
PH-505A	A	SPDT MOMENTARY	B21	.30	305-173	C	DPDT	8710K3	.55
PH-505	A	SPST	AN-3022-2B	.30	305-175	C	DPDT CENTER OFF MOM EACH SIDE	3712K3	.50
PH-506	A	SPDT CENTER OFF	AN-3022-1	.35	305-179	C	DPDT CENTER OFF MOM EACH SIDE	8732-K2	.50
PH-507	A	SPDT CENTER OFF MOM EACH SIDE	AN-3022-7B	.32	309-163	C	DPDT CENTER OFF MOMENTARY	CH C-11	.55
PH-508	A	SPST MOMENTARY	AN-3022-8	.28	309-162	C	DPST	CH C-1	.45
PH-513	A	SPDT CENTER OFF	CH AN-3022-1B	.38	309-164	C	DPST MOMENTARY	CH 8711K3	.40
PH-514	A	SPST	CH B-5 A	.35	370-31	C	DPDT	CH C-1B	.55
PH-516	A	SPST	B5	.35	305-87	D	1 SIDE DPST MOM 1 SIDE SPST	AH & H	.95
LT-104	A	SPDT 1 SIDE MOMENTARY	CH 8905K568	.35	LT-100	F	SPST	CH	.22
309-168	A	SPST	168553	.30	LT-101	F	SPST MOMENTARY	AH & H w/LEADS	.20
370-1	A	SPST MOMENTARY	CH AN-3022-8B	.25	301-51	G	4PDT MOMENTARY	CH 8905K12	.75
370-4	A	SPDT CENTER OFF	CH B-9A	.35	305-140	H	DT NO MAKE EACH SIDE	OPEN FRAME	.25
370-14	A	SPDT CENTER OFF 1 SIDE MOM.	CH B-7A	.30	309-161	K	SPST	CH 8781K3	1.95
370-25	A	SPST MOMENTARY	CH B-6B	.25	305-76	L	DPST	AH & H OPEN FRAME	.75
305-171	A	SPDT CENTER OFF MOM 1 SIDE	8209K5	.32	301-12	M	DPST	AH & H SPECIAL FOR HANDY	.40
309-169	B	SPST MOMENTARY	CH B-19	.35					
PH-509	C	DPST	AN-3023-2B	.45	LT-107	N	DPST	AH & H TALKIE	.25
PH-510	C	DPDT MOMENTARY	CH 8715K2	.50					
PH-511	C	DPDT MOMENTARY	CH 8715K3	.50					
PH-512	C	DPST CENTER OFF	CH 8720K1	.55					
PH-515	C	DPDT CENTER OFF	C-9A-8700K2	.55					
PH-517	C	DPDT	C-5A-8701K2	.55					
303-65	C	DPST	CH AN-3023-2	.45					

Distributors: Our standard distributor arrangement applies on these items.

Many More Types in Stock. Send Us Your Requirements.

JUST OUT: CATALOG H500 Manufacturers, Distributors and Amateurs write for the brand new Wells Electronic Catalog H500. Full of tremendous values in highest quality components.



Order directly from this ad or through your local parts jobber—

320 N. LA SALLE ST. DEPT. SL, CHICAGO 10, ILL.

1000 KC crystal BT cut. \$3.95
 3" scope shield. 1.29
 2 speed dial drive for 1/4" shaft ratios 5-1 to 1 29
 ATC 100 mmfd air trimmer screwdriver shaft. 29
 -10 +5 Weston modulation meter Weston 301. 8.95
 J37 key69
 500 watt 12.5 ohm power rheostat. 3.49



50 mmfd 5 KV GE vacuum condenser. \$1.49
 2v, 6v, 12v vibrators any type.98
 Rotary switch GE Mycalex, 2 deck SP3T.39
 1 mfd 5000v oil condenser Micromold. 2.98
 2 mfd 3000v oil condenser Aeromox. 3.25
 3 mfd 4000v oil condenser Micromold. 3.95
 24 mfd 1500v DC 3KV flash. Excellent for speed lamp 3.95

TUBES!! BRAND NEW! STANDARD BRANDS! NO SECONDS! COMPARE! TUBES!!

0A3/VR75	3C24/340	\$.39	227A/5C27	812	\$2.45	8014	\$19.95	0A2
0B3/VR90	3C45	12.75	249C	813	6.85	8025	3.69	5Z4
0C3/VR105	3CP1	1.39	250R	814	2.25	9001	.39	6A4
0B3/VR150	3CP1-S1	2.39	250TH	815	2.25	9002	.39	6AT
1B22	2.95	3DP1	3.10	816	1.05	9003	.49	6AR
1B23	8.75	3DP1A	3.95	820	.39	9004	.34	6AB7
1B24	4.95	3PT7-S2A	4.75	828	9.95	9005	1.49	6AC5GT
1B26	2.95	3D21A	.98	829	4.49	9006	.18	6AC7
1B27	24.50	3E29	9.95	820B	9.95	C1JA	9.95	6AD7G
1B29	2.75	3FP7	1.15	830B	3.19	C8B	6.75	6AG5
1B32	3.49	3HP7	4.75	830A	4.45	CGA	9.75	6AF6
1B36	24.96	3HP7	2.89	832A	7.95	CGJ	4.45	6AG5
1B38	32.50	4-65A	14.21	833A	33.95	CK502AX	1.49	6AG7
1N21 Xtal	4-125A	2.95	303A	834	2.45	CK505AX	2.95	6AH6
1N21A Xtal	4-250A	29.95	307A/RK75	835	1.35	CK503AX	2.95	6AJ5
1N21B Xtal	4AP10	3.95	310A	838	2.35	CK505AX	2.25	6AK5
1N22 Xtal	4B25/FL3B	4.95	316A	841	3.77	CK507AX	2.25	6AK8
1N23 Xtal	4B25/6CF	7.50	327A/B	845	3.75	CK512AX	2.25	6AL5
1N23A Xtal	4H26/2000	4.95	328A	849	13.95	CK571AX	8.45	6AQ5
1N23B Xtal	4H28	2.95	331A	855	6.25	CK1005	.63	6AR5
1N27 Xtal	4B32	9.95	350A	860	6.95	E1148	.29	6AT6
1N34 Xtal	4C27/CV96	49.50	368AS	864	10.49	F123A	7.95	6AV6
1P23	4C35	22.50	371A	865	1.45	F127A	22.50	6BA4
1P24	4D22	9.95	371B	866	8.50	F206	8.50	6BB6
1P36	2.69	4D22	9.95	866JR	1.05	F606	37.50	6BT
1P41	3.79	4E27/257B	1.05	869R	26.50	F690	49.50	6BR8
2AP1	4.95	4E27/257B	1.05	872A	1.99	FG17	3.95	6B8G
2AP5	4.95	5AP1	14.95	876	1.69	FG27A	8.75	6B9A
2AP5/RK33	5AP4	1.79	434A	876	1.69	FG57	12.95	6BB6
2C22/7193	5BP1	2.29	446A	876	1.69	FG57	12.95	6BB6
2C26A	5BP1	2.29	446A	876	1.69	FG57	12.95	6BB6
2C34/RK34	5CP1	1.39	450TH	885	1.39	FG81A	3.29	6B16
2C38	5CP1	1.39	450TH	900	3.39	FG105	29.50	6B16
2C40	5CP7	3.49	450TH	902	3.39	FG105	29.50	6B16
2C43	5CP7	3.49	450TH	908	7.95	GL146	8.95	6C6
2C44	5CP7	3.49	450TH	918	1.49	GL434A	2.89	6C8G
2C46	5FP7	1.19	562	918	1.49	GL502A	1.85	6E3
2C51	5FP7	1.19	562	923	7.72	GL502A	49.50	6F6
2D22	5IP4	24.45	702A	927	1.09	GL502A	49.50	6F6GT
2E22	5IP4	24.45	702A	930	1.95	GL502A	49.50	6F6GT
2E24	5IP4	24.45	702A	931A	3.59	HP125	14.95	6F6GT
2E26	5IP4	24.45	702A	954	1.19	HP300B	19.95	6F8G
2E30	5IP4	24.45	702A	955	1.19	HY115	.79	6G6G
2I21A	5P30	49.50	706B	957	1.22	HY115	.79	6H0GT
2I22	5P30	49.50	706B	958	1.22	HY115	.79	6J5
2I26	5NP1	2.49	706GY	958	1.22	HY115	.79	6J5GT
2I27	6C21	18.95	706GY	961/NE16	.22	ML101	49.50	6L6
2I30	6C21	18.95	706GY	1603	1.98	ML101	49.50	6L6GT
2I31	6C21	18.95	706GY	1614	1.29	ML101	49.50	6L6GT
2I33	6C21	18.95	706GY	1614	1.29	ML101	49.50	6L6GT
2I34	6C21	18.95	706GY	1614	1.29	ML101	49.50	6L6GT
2I36	6C21	18.95	706GY	1614	1.29	ML101	49.50	6L6GT
2I37	6C21	18.95	706GY	1614	1.29	ML101	49.50	6L6GT
2I38	6C21	18.95	706GY	1614	1.29	ML101	49.50	6L6GT
2I39	6C21	18.95	706GY	1614	1.29	ML101	49.50	6L6GT
2I40	6C21	18.95	706GY	1614	1.29	ML101	49.50	6L6GT
2I41	6C21	18.95	706GY	1614	1.29	ML101	49.50	6L6GT
2I42	6C21	18.95	706GY	1614	1.29	ML101	49.50	6L6GT
2I43	6C21	18.95	706GY	1614	1.29	ML101	49.50	6L6GT
2I44	6C21	18.95	706GY	1614	1.29	ML101	49.50	6L6GT
2I45	6C21	18.95	706GY	1614	1.29	ML101	49.50	6L6GT
2I46	6C21	18.95	706GY	1614	1.29	ML101	49.50	6L6GT
2I47	6C21	18.95	706GY	1614	1.29	ML101	49.50	6L6GT
2I48	6C21	18.95	706GY	1614	1.29	ML101	49.50	6L6GT
2I49	6C21	18.95	706GY	1614	1.29	ML101	49.50	6L6GT
2I50	6C21	18.95	706GY	1614	1.29	ML101	49.50	6L6GT
2I51	6C21	18.95	706GY	1614	1.29	ML101	49.50	6L6GT
2I52	6C21	18.95	706GY	1614	1.29	ML101	49.50	6L6GT
2I53	6C21	18.95	706GY	1614	1.29	ML101	49.50	6L6GT
2I54	6C21	18.95	706GY	1614	1.29	ML101	49.50	6L6GT
2I55	6C21	18.95	706GY	1614	1.29	ML101	49.50	6L6GT
2I56	6C21	18.95	706GY	1614	1.29	ML101	49.50	6L6GT
2I57	6C21	18.95	706GY	1614	1.29	ML101	49.50	6L6GT
2I58	6C21	18.95	706GY	1614	1.29	ML101	49.50	6L6GT
2I59	6C21	18.95	706GY	1614	1.29	ML101	49.50	6L6GT
2I60	6C21	18.95	706GY	1614	1.29	ML101	49.50	6L6GT
2I61	6C21	18.95	706GY	1614	1.29	ML101	49.50	6L6GT
2I62	6C21	18.95	706GY	1614	1.29	ML101	49.50	6L6GT
2I63	6C21	18.95	706GY	1614	1.29	ML101	49.50	6L6GT
2I64	6C21	18.95	706GY	1614	1.29	ML101	49.50	6L6GT
2I65	6C21	18.95	706GY	1614	1.29	ML101	49.50	6L6GT
2I66	6C21	18.95	706GY	1614	1.29	ML101	49.50	6L6GT
2I67	6C21	18.95	706GY	1614	1.29	ML101	49.50	6L6GT
2I68	6C21	18.95	706GY	1614	1.29	ML101	49.50	6L6GT
2I69	6C21	18.95	706GY	1614	1.29	ML101	49.50	6L6GT
2I70	6C21	18.95	706GY	1614	1.29	ML101	49.50	6L6GT
2I71	6C21	18.95	706GY	1614	1.29	ML101	49.50	6L6GT
2I72	6C21	18.95	706GY	1614	1.29	ML101	49.50	6L6GT
2I73	6C21	18.95	706GY	1614	1.29	ML101	49.50	6L6GT
2I74	6C21	18.95	706GY	1614	1.29	ML101	49.50	6L6GT
2I75	6C21	18.95	706GY	1614	1.29	ML101	49.50	6L6GT
2I76	6C21	18.95	706GY	1614	1.29	ML101	49.50	6L6GT
2I77	6C21	18.95	706GY	1614	1.29	ML101	49.50	6L6GT
2I78	6C21	18.95	706GY	1614	1.29	ML101	49.50	6L6GT
2I79	6C21	18.95	706GY	1614	1.29	ML101	49.50	6L6GT
2I80	6C21	18.95	706GY	1614	1.29	ML101	49.50	6L6GT
2I81	6C21	18.95	706GY	1614	1.29	ML101	49.50	6L6GT
2I82	6C21	18.95	706GY	1614	1.29	ML101	49.50	6L6GT
2I83	6C21	18.95	706GY	1614	1.29	ML101	49.50	6L6GT
2I84	6C21	18.95	706GY	1614	1.29	ML101	49.50	6L6GT
2I85	6C21	18.95	706GY	1614	1.29	ML101	49.50	6L6GT
2I86	6C21	18.95	706GY	1614	1.29	ML101	49.50	6L6GT
2I87	6C21	18.95	706GY	1614	1.29	ML101	49.50	6L6GT
2I88	6C21	18.95	706GY	1614	1.29	ML101	49.50	6L6GT
2I89	6C21	18.95	706GY	1614	1.29	ML101	49.50	6L6GT
2I90	6C21	18.95	706GY	1614	1.29	ML101	49.50	6L6GT
2I91	6C21	18.95	706GY	1614	1.29	ML101	49.50	6L6GT
2I92	6C21	18.95	706GY	1614	1.29	ML101	49.50	6L6GT
2I93	6C21	18.95	706GY	1614	1.29	ML101	49.50	6L6GT
2I94	6C21	18.95	706GY	1614	1.29	ML101	49.50	6L6GT
2I95	6C21	18.95	706GY	1614	1.29	ML101	49.50	6L6GT
2I96	6C21	18.95	706GY	1614	1.29	ML101	49.50	6L6GT
2I97	6C21	18.95	706GY	1614	1.29	ML101	49.50	6L6GT
2I98	6C21	18.95	706GY	1614	1.29	ML101	49.50	6L6GT
2I99	6C21	18.95	706GY	1614	1.29	ML101	49.50	6L6GT
2I00	6C21	18.95	706GY	1614	1.29	ML101	49.50	6L6GT

812	\$2.45	8014	\$19.95	0A2
813	6.85	8025	3.69	5Z4
814	2.25	9001	.39	6A4
815	2.25	9002	.39	6AT
816	1.05	9003	.49	6AR
820	.39	9004	.34	6AB7
8				

TEST EQUIPMENT

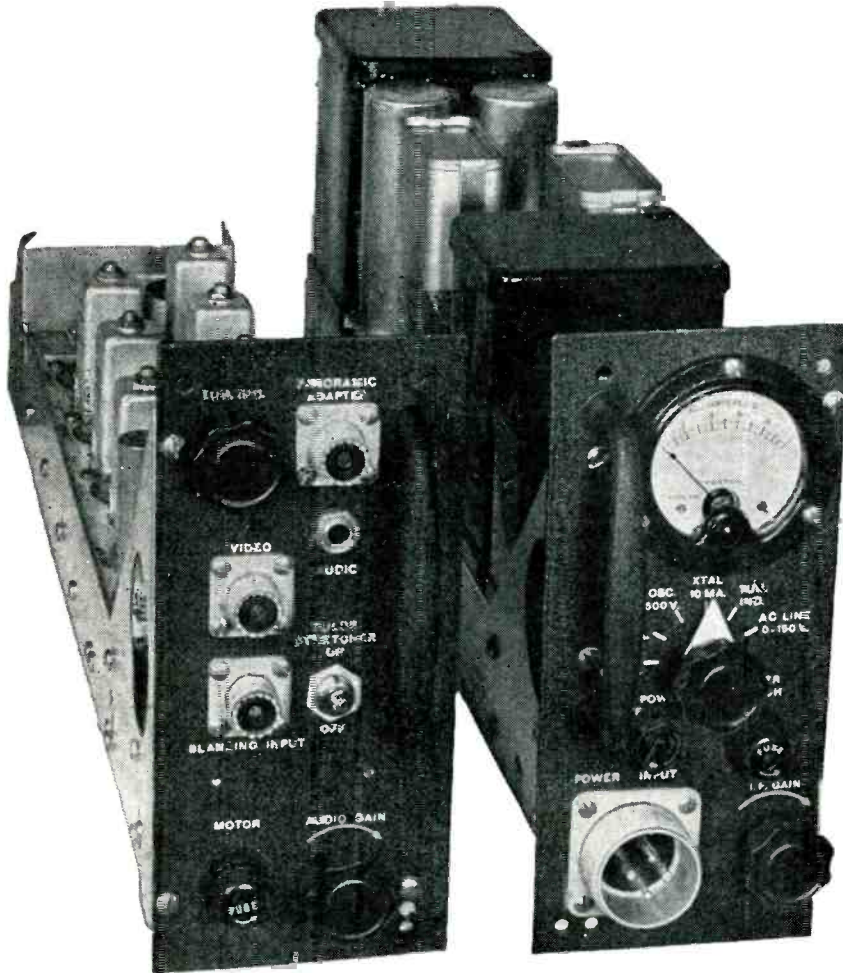

30 MC I.F. STRIP, VIDEO, and AUDIO AMPLIFIER AND 110 Volt 60-2600 cps POWER SUPPLY, Bandwidth 10 mc, new, part of APR-5 Receiver. \$65.00 less tubes

AMPLIFIER STRIP AM-SSA/SPR-2 contains I. F. amplifier, detector, video amplifier, pulse stretcher and audio amplifier and Rectifier Power Unit PP-155A/SPR-2 bandwidth 10 mc, center frequency 30 mc, sensitivity 50 microvolts for 10 milliwatts output. Power supply 80/115 V ac, 60-2600 cps 1.3 amps.

K Band Test Load low power. . . \$20.00

X Band Below Cut-Off Wave Guide Attenuator, with calibrated dial, type N input connector, output connects to 1/2" x 1" wave guide \$55.00

X Band Test Load, low power. . . \$15.00

TS-62 X Band Echo Box with r.f. cable and pick-up antenna.

TS-33 X Band Frequency Meter, 8500-9600 Mcs. Crystal detector and 50 micro-amp. meter. Indicates Resonance. Connection for scope available.

TS-125 CALIBRATED S BAND POWER METER with attenuator.

TS-155 S BAND SIGNAL GENERATOR and Power Meter.

APR-1 or APR-4 Radar Search Receiver, 30 mc I.F., 2 mc wide.

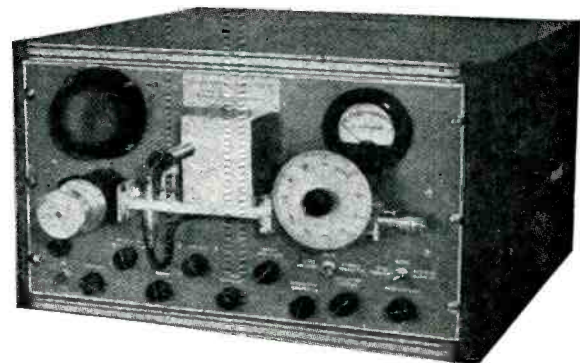

Tuning Units For APR-1 or APR-4 Receivers (can be used with any 30 mc amplifier):

TN-19, range 1000-2000 mc, tuned mixer cavity \$150.00

TN-54, range 2000-4000 mc, tuned mixer cavity \$150.00

TS-110 S Band Echo Box 2400-2700 mc, portable \$110.00

TS-184 Echo Box and Attenuator for APS-13

TS-170 Test Oscillator for ARN-5

TS-226 Peak Power Meter for APS-13

TS-89 Voltage Divider for measuring high video pulses, ratios, 1:10 and 1:100, transmission flat within 2db 150 c.p.s. to 5 mc., with cable for attaching to syndroscope.

Waveguide Below Cut-off Attenuator L-101-A U.H.F. Connectors at each end, calibration 30-100 db. \$10.00

X Band Test Load, 50 watts, average power, 1/2" x 1" waveguide, Sand load \$35.00

HI POWER X BAND TEST LOAD, dissipates 280 watts of average power for 1/8" x 1 1/4" waveguide, VSWR less than 1.15 between 7 and 10 KMC. . . \$150.00

HI POWER S BAND TEST LOAD, dissipates 1000 watts of average power, for 1 1/2" x 3" wave guide. Range 2500 to 3700 MC.

TS-45A/APM-3 Signal Generator, 9200-9600 mc, 110 V, 60-800 cps.

TS-35/AP X Band Signal Generator, pulsed, calibrated power meter, frequency meter, 8700-9500 mc.

X Band VSWR Test Set TS-12/AP, complete with linear amplifier, direct reading VSWR meter, slotted waveguide with gear driven traveling probe, matched termination and various adapters, with carrying case.

Standard Signal Generator Measurements 65B, 100 kc to 30 mc, 1-2,000,000 micro-volts, good working order. \$400.00

S Band Mixer, tunable by means of slider type N connector for the R.F. and local oscillator input, U.H.F., connector for the I.F. output, variable oscillator injection \$30.00

ELECTRO IMPULSE LABORATORY

P. O. Box 250

Eatontown 3-0007

Red Bank, N. J.

X Band Spectrum Analyzer 8500-9600 Mc., calibrated linear below cut-off attenuator, calibrated frequency meter, tuned mixer, 4 i.f. stages, 3 video stages overall gain 125 db., regulated power supply.

S Band Spectrum Analyzer 2700-3400 Mc., similar to above.

IMMEDIATE DELIVERY

LOW PRICES

FULLY GUARANTEED

BROWN TELEPLOTTER RECEIVER

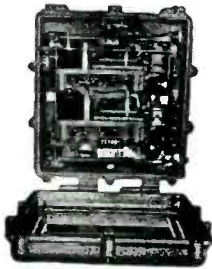

Model 791X1R
115 volt 60 cycles

Contains a pen driven by two balancing motors which writes on rear of a translucent chart. Pen arm position is in terms of two coordinates supplied balancing motors thru two amplifiers. Originally intended for recording plotted or written data from central plotting board. Writes at one half scale on 18 in. chart. Discriminator input circuit designed to operate unit as function of two varying R.F. frequencies varying about mean of approx. 430 KC. Further data on request. (Shipping weight 435 lbs.)

Price \$375.00

Aircraft Generator Eclipse NEA-3



Output 115 VAC; 10.4 amps 800 cycles at 2400 rpm. Also 30 VDC at 6 amps. Stock #SA-306. Price \$39.50 each.



400 Cycle Generators
Homelite 18A120D28-1 400 cycle out at 1 phase 115 v. 39 amps. Also a d-c output of 28 v. and 17.9 amps. Special at \$175.00 each.



C-1 Autopilot Amplifier

Three channel servo amplifier for use in C-1 Autopilot. 7 tubes. Stock #SA-172. Price \$24.50 each.



Pioneer Servo Motor

Type 10047-2A. 2 ϕ 100 cycle low inertia. 26 v fixed phase. 15 v. max. variable phase. Stock #SA-30. Price \$12.50 each.



PRECISION AUTOSYN

Pioneer Type AY-150 Control Autosyn. Precision type. 26 v. 400 cycle. Stock #SA-237. Special low price \$14.50 each.

SYNCHROS

Navy Types

1G, 1CT, 5G, 5F, 5CT, 5DG, 5HCT, 5SF, 5HSF, 5SDG, 6DG, 7G, etc.

Prices on Request



Prices F.O.B. Paterson
Phone ARmory 4-3366
WRITE FOR LISTING



Compass Indicator

I-82F Compass Indicator. 0-360°-5 in. dial. 26 v. 400 cy. 8-12 v. 60 cy. ideal position indicator. Stock #SA-234.

Price \$6.50 each

SWEEP GENERATOR CAPACITOR



Hi-speed bearings. Split stator. Silver-plated coaxial type. 5-10 mmf.

Stock #SA-167

Price \$2.75 each

ALSO IN STOCK

C-1 AUTOPILOT COMPONENTS
A-5 AUTOPILOT GYROS
GENERAL ELECTRIC D-C SELSYNS
AC and DC RATE GENERATORS

400 CYCLE AC BLOWERS

E. A. D. J-151—115 v. 400 cy. 22 c.f.m.
Westinghouse Type FL—115 v. 400 cy. 17 c.f.m.

DC MOTORS

Haydon-0666. 1/2 rpm. 29 v. d-c. 100 ma.
Delco 5069625—120 rpm. Gov. cont. 27 v.
General Electric 5BA50LJ66—1/2 hp. 27 v. field. Arm. v. 60. Amplidyne controlled.
Delco-A-7135—1/30 hp. 3400 rpm. Gov. cont.

W. E. KS-5603-L02—1/100 hp. 4 lead shunt.
National Mineral—90600. 1 hp. Int. duty. Fan cooled.

Diehl FDE-53-5—3500 rpm. Gov. cont. 1/30 hp.
G. E. 5BA25MJ109—24 v. 7500 rpm. Cont. duty.

Airsearch—Actuator—25800-24. 2" travel.
Barber Colman—Actuator—YLc-2066-2. 200 in. lb. 135 degrees in 45 seconds.

Airsearch—Actuator (Manual Flap) 25080.
Airsearch—Actuator—(Automatic Flap) 25090.

Holtzer Cabot—RBD-2220—1/2 hp. 27 v. 3400 rpm.
Arma Latitude Motor—S413-30 (Step motor)

Elinco B-64—1/165 hp. 3100 rpm. 27 v. f. 80 v. armature. (Thyratron control)
John Oster—A-21E-12R—Split field series reversible. 28 v. 0.4 amps. 2 watts output.

General Electric 5PS56HC18—Split field series rev. 60 v. 1.4 A. 3500 rpm.

AC SERVO MOTORS

Kollsman—776-01—400 cy. 2 ϕ drag cup type.
Diehl FP-25-3—2 ϕ 60 cy. 20 v. 2.5 watts out.

Pioneer CK-2—2 ϕ 400 cy. 1.05 in/oz. stall.
Pioneer CK-17—2 ϕ 400 cy.

Minneapolis—Honeywell G303AY2CA4. Built in gear reduction. 2 ϕ 400 cy.

AUTOSYNS (Pioneer)

B-9A—Dual Oil Pressure Indicator (6007-4F-7A)
B-9A—Oil Pressure Transmitter. (4150-333)

Pioneer Types—AY-1. AY-14, AY-54, 2320, etc.

C-1A—Fuel Pressure Transmitter.
Pioneer I-81A and I-82A Compass Indicators.

Subfractional Horsepower AC Motors

Eastern Air Devices—J-72B—115 v. 400 cy. 1/50 hp. Cont. duty. 4700 rpm.

E. A. D. J-31—115 v. 400 cy. 1/100 hp.
E. A. D. J-49B—115 v. 400 cy. 1/250 hp.
E. A. D. J-33—115 v. 3 ϕ 400 cy. Int. duty.

Diehl FBF-24-1—115 v. 400 cy. 1/100 hp.
Synchro-600—110 v. 60cy. 1 rpm.
Haydon 36228—115 v. 60 cy. 1 rpm.

MAGNESYNS

Pioneer Type CE-3. 6 power.
Pioneer 1006-1E-B1 Indicator. AN-5730-2.

INVERTERS

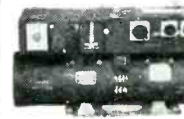

Wincharger PU-7/AP
Input 28 VDC at 160 amps. Output 115 v. 400 cy. 1 ϕ at 2500 VA. Voltage and frequency regulated. Cont. duty. Stock #SA-164. Price \$79.50 each.



G.E. 5AS131N33 (PE-118)
Input 26 VDC at 100 amps. Output 115 v. 400 cy. 1 ϕ at 1500 VA. PF 0.8 W.E. Spec. KS-5601L1. Stock #SA-286. Price \$29.50 ea.

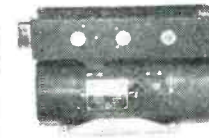

PE-218E Inverters
Russel Electric and Leland. Input 28 VDC at 92 amp. Output 115 v. 400 cycles at 1500 VA. PF 0.9. Stock #SA-112A. Price \$49.50 each.



Pioneer 12130-4-15
(3 ϕ) Input 28 VDC at m.p.s. Output 115 v. 400 cy. 3 ϕ at 100 VA. Voltage and frequency regulated. Made 1949. Stock #SA-304. Price \$69.50 each.

JACK AND HEINTZ STARTER

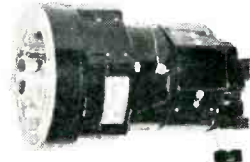

Dwg. 6-950-R
Aircraft engine starter. 28 VDC. Stock #SA-305. Price \$19.50 each

DC SERVO MOTOR



Elinco Type B-64.
1/165 hp at 3100 rpm. Field volts 27.5 Max. armature voltage 80. Ideal for thyratron servo control. Stock #SA-211. Price \$12.50 each.

MAGNETIC AMPLIFIER ASSEMBLY

Sperry 661824. Saturable reactor type output transformer. Designed to supply one phase of 400 cycle servo motor. Stock #SA-266. Price \$6.75 each

FORD INS'T SERVO MOTOR



115 volt 60 cycle two phase low inertia motor. 15 watts output. BuOrd. 207927. Stock #SA-291. Price \$49.50 each.

products co.
Servo-Tek
4 Godwin Ave. Paterson, N. J.

SPECIALISTS IN FRACTIONAL HORSE POWER MOTOR SPEED CONTROL

GENERAL ELECTRIC TUBE SPECIALS

Brand New Mfd. by G.E.					
12GP7	12.85	FG-95	20.60	GL-415/	
1P24	.79	FG-105	10.95	5550	22.00
FG-32	4.25	FG-172	19.50	8020	1.39
FG-33	11.95	FG-190	12.15	189048	3.79
FG-81A	4.95	2C39	13.50	189049	3.79

GENERATORS

- Eclipse-Pioneer type 716-3A (Navy Model NEA-3A) Output—AC 115V 10.4A 800 to 1400 cy 1 ϕ DC 30 Volts 60 Amps. Brand New—Original Packing \$38.50
- Eclipse-Pioneer type 1235-1A. Output—30 Volts 15 Amps. Brand New—Original Packing.....\$9.50

PIONEER SERVO SYSTEM UNITS

- Type 12073-1A Torque Amplifier, Input 115 V 400 cy. Complete with Tubes.....\$14.95
- Magnetic Amplifier Assy. Saturable Reactor Type to supply one phase of 400 cycle Servo Motor \$5.95

COAXIAL CABLE

RG-8-U—\$60.00 per 1000 ft.—Other types in stock

SPRAGUE PULSE NETWORKS

- 7.5 E3-1-200-67P, 7.5 KV, "E" Circuit 1 microsec. 200 PPS, 67 ohms Imped. 3 sections.....\$4.30
- 7.5 E3-3-200-67P, 7.5 KV, "E" Circuit 3 microsec. 200 PPS, 67 ohms Imped. 3 sections.....\$6.75
- 7.5 E4-16-67P, 7.5 KV, "E" Circuit 4 sections. 16 microsec. 60 PPS, 67 ohms Imped.....\$8.25
- 15—E4-15-600-50P, 15 KV "E" Circuit 1.5 microsec. 600 PPS, 50 ohms Imped. 4 sections.....\$12.00
- 15—E6-5-180-50P, 15 KV, "E" Circuit 5 microsec. 180 PPS, 50 ohms Imped. 6 sections.....\$25.00

ASB YAGI ANTENNA

5 ELEMENT ROTATABLE ARRAY—450 TO 560 MC \$7.00

SAME EXCEPT DOUBLE STACKED 6 ELEMENT 450 TO 560 MC \$12.70

Same Except Double Stacked 6 Element 370 to 430 MC \$29.40

Double stacked antennas can be supplied with hydraulic remote controls at \$29.50 per set additional.

SELENIUM RECTIFIER STACKS

FULL WAVE BRIDGE		MAXIMUM RATINGS	
DC VOLTS INPUT	AC VOLTS INPUT	DC VOLTS INPUT	AC VOLTS INPUT
18	14.5	34	34
1.2 Amps.....	\$2.64	0.6 Amps.....	\$3.00
2.4.....	3.07	1.2.....	3.44
4.4.....	4.09	3.2.....	5.15
13.0.....	7.67	6.0.....	9.32
17.5.....	8.69	9.0.....	10.05
26.....	15.33	12.....	18.64
39.....	23.00	18.....	20.12
52.....	30.67	24.....	35.96
65.....	38.33	36.....	41.24

All voltage and current ratings based on continuous operation in 35°C. (95°F) ambient, self-cooled. Current ratings can be increased up to 2 1/2 times normal ratings by intermittent operation or forced cooling.

PULSE TRANSFORMERS

UTAH 9262.....	\$2.75
UTAH 9278.....	\$2.75
G. E. 68G-627.....	\$4.75
AN/APN-9 (901756-501).....	\$1.50
AN/APN-9 (901756-502).....	\$1.50
AN/APN-4 Block, Osc.....	\$1.25

W. E. MERCURY CONTACT RELAYS

Glass sealed mercury wetted SPDT contact assemblies. Magnetically operated. Used in Western Electric D-168479 high speed plug in relays. Supply your own coil.....\$2.00 each

CONSTANT VOLTAGE TRANSFORMERS

Federal Constant Voltage Transformer Input 95-135V 50/60cy Output 115V 210W.....	\$34.00
Raytheon VR-5 Constant Voltage Transformer Input 95-130V 60cy-Output 115V 500W.....	\$38.50
Sola Constant Voltage Transformer Input 95-125V 60cy-Output 15.8V 285VA.....	\$24.70
Sola Constant Voltage Transformer Input 105-125V 60cy-Output 115V 80VA.....	\$15.95

TYPE "J" POTENTIOMETERS

75¢ each

Resis.	Shaft	Resis.	Shaft	Resis.	Shaft
100	SS 10K	SS 100K	5/16"	100	SS 10K
200	SS 15K	SS 100K	3/8"	500	SS 15K
500	SS 20K	SS 100K	1/2"	650	SS 25K
5000	SS 25K	SS 100K	3/4"	6500	SS 30K
10K	SS 30K	SS 100K	1 1/4"	10K	SS 50K
10K	SS 50K	SS 100K	1 1/2"		

Triple 100K - 3/4" Shaft - 1.47
All shaft lengths beyond bushing - SS (screw slot)

STANDARD BRANDS ONLY

TUBE SPECIALS

BRAND NEW FIRST QUALITY

COMPLETE STOCK OF RECEIVING, TRANSMITTING, CATHODE RAY, THYRATRON, IGNITRON, MAGNETRON, KLYSTRON, PHOTOCCELL, T-R & ATR TUBES. QUOTATIONS UPON REQUEST

WESTINGHOUSE HYPERSIL TRANSFORMER



PRI-115V. 60CY 3/4 KVA
SEC #1 - 240V - 1.56A
SEC #2 - 240V - 1.56A
WT. 30 LBS.
\$11.50 EACH

KOLLSMAN INSTRUMENT LOW INERTIA MOTOR

Type 937-0240—85/68 Volts—100 Cycles 2 Phase—5 Watts—2650 RPM
Will Operate Satisfactorily at 60 Cycles
Original Price \$34.50—Our Price—\$8.22 ea.
\$7.50 EACH—Lots of 10

SOUND POWERED TELEPHONES

- U. S. INSTRUMENT Type A-260
 - WESTERN ELECTRIC Type D-173013
 - AUTOMATIC ELECTRIC Type GL-832BA0
 - U. S. NAVY TYPE M HEAD AND CHEST SETS
- These are high quality heavy-duty units not to be confused with cheaper units now available. Designed to withstand exacting shock, vibration, salt water corrosion, temperature and pressure tests. ANY TYPE \$14.88 ea., \$28.00 per pair.
TS-10 Handsets.....\$8.92 each

MISCELLANEOUS EQUIPMENT

ID-6APN-4 Indicator.....	\$29.50
R-7/APS-2 Receiver.....	49.50
R-78/APS-15 Receiver.....	49.50
SCR-522 Transceiver.....	32.50
RT-7/APN-1 Transceiver.....	8.95
FL-8 120 cycle filter.....	1.37
RM-29 remote control unit.....	8.95
RM-14 remote control unit.....	8.95
RTA-1B 12/24 V dynamotor.....	30.00
BC-1206 Receiver.....	6.95
A1A Antenna—3cm conical scan.....	120.00
AT-38A/APT antenna (70-400 MC).....	13.70
AT-49/APR-4 antenna (300-3300 MC).....	13.70
CY-230/MPG-1 Radar Console.....	575.00
G. E. Type JP-1 portable current transformer.....	32.50
AT-8/AP Antenna.....	3.95
ASB-4 Radar equip. Complete.....	69.75
DZ-2 loop antenna with pedestal.....	14.50

MONTHLY BULLETINS

SEND IN YOUR NAME AND ADDRESS TO GET ON OUR MAILING LIST

All material brand new and fully guaranteed. Terms 20% cash with order, balance C. O. D. unless rated. All prices F.O.B. our warehouse, Phila., Penna., subject to change without notice.

COAXIAL CONNECTORS



83-1AC	.42 UG-12/U	.63 UG-86/U	1.22
83-1AF	.15 UG-7/U	.67 UG-87/U	.68
83-1F	1.12 UG-22/U	.86 UG-171/U	1.33
83-1H	.10 UG-23/U	.63 UG-175/U	.15
83-1J	.80 UG-24/U	.67 UG-176/U	.15
83-1R	.35 UG-27/U	.68 UG-180A/U3.82	
83-1SP	.35 UG-29/U	.83 UG-191/AP	.57
83-1SPN	.35 UG-30/U	.94 MX-195/U	4.11
83-1T	1.12 UG-34/U	12.80 UG-197/U	1.33
83-22AP	1.10 UG-36/U	12.80 UG-206/U	.58
83-22F	1.48 UG-37/U	12.80 UG-255/U	.82
83-22R	.48 UG-58/U	.57 UG-264/U	1.74
83-22SP	.85 UG-85/U	.62 MX-367/U	.15

FULL LINE OF JAN APPROVED COAXIAL CONNECTORS IN STOCK

COMPONENT SPECIALS

Fuses	4AG	10 Amp.	\$3.00/c
	4AG	20 Amp.	\$3.00/c
MOLDED PAPER CONDENSERS—			
.02 MFD	200 VDC	.04 1/2 Ea.	\$3.00 per 100
.05	200	.04 1/2	3.00
.1	200	.04 1/2	3.00
.25	200	.06	4.00
.1	400	.09	6.00
.005	600	.09 1/2	6.00
.01	600	.07	4.75
.05	600	.08	5.50

CRYSTAL DIODES—

1N21	.79	1N22	.89	1N34	.69
1N21A	1.19	1N23	1.19	1N45	.94
1N21B	2.25	1N27	1.09	1N63	1.39

Phase shift capacitor—Type D—150734—4 stator single rotor.....\$2.69

HIGH VOLTAGE MICA CAPACITORS—

Type G-1	.004 mfd	6 KV	\$6.35
Type G-3	.0015 mfd	20 KV	12.70
Type UC-3260	.0005 mfd	20 KV	6.9
Type UC-2317K	.0035 mfd	4 KV	3.10
Type UC-2938K	.002 mfd	5 KV	3.15
Type UC-3135A	.00005 mfd	35 KV	11.95

OIL-FILLED CAPACITORS

50 MFD	220 VAC	\$3.95
60 MFD	350 VAC	\$5.75
32 MFD	2500 VDC	\$10.80
7 MFD	660 VAC	\$2.95
3.5-.5 MFD	1000 VDC	.95
.1 MFD	7000 VDC	\$1.79
.045 MFD	16 KVDC	\$4.70

SPECIAL
2 MFD 12,500 VDC
INERTEEN TYPE FP
\$23.95

RCA HI-VOLTAGE TRANSFORMER

Pri—115/230V. 60CY
Sec—6000V—80 MA
\$11.80



Insulated for Voltage Doubler Use

TEST EQUIPMENT

- Alfred W. Barber Labs. Mod. VM-25 VTVM.....\$86.00
 - General Radio Model P-500A Standard Signal Generator (Same as G. R. 805A except covers 9KC to 32 MC).....\$450.00
 - TS-10A/APN Delay Line Test Set.....\$25.00
 - TS-19/APQ-5 Calibrator.....\$75.00
 - AT-48/UP "X" Band Horn.....\$39.95
 - REL W-1158 Frequency Meter 160-220 MC.....\$32.95
 - CW1-60AAG Range Calibrator for ASB, ASE, ASV and ASVC Radars.....\$39.95
 - CRV-14AS Phantom Antenna for Transmitters up to 400 MC.....\$11.75
 - TS-146/AP X-Band Test Set. Price on request.
 - TS-184/AP.....Price on request.
 - CPR-60AAJ and CPR-60AAK—IFF Test Sets.....(pair) \$16.95
 - Hewlett Packard Model 200-C Audio Oscillators (10 available).....\$87.50
 - C-D Quietone Filter Type IF-16 110/220 V AC/DC 20 Amps.....\$9.00
- All items New Except Where Noted (Exc. Used Condition)

FILAMENT TRANSFORMERS

(All 115V 60cy primary except where noted)

UTC herm. sealed 5V @ 1A.....	1.22
UTC herm. sealed 6.3V @ 0.6A.....	1.33
UTC herm. sealed 6.3V @ 3.2A.....	2.21
Raytheon herm. sealed 6.3VAC @ 0.6A.....	1.35
Raytheon herm. sealed 6.3VCT @ 3A, 6.3V @ 0.5A.....	2.31
G.E.—6.3V @ 13A, 6.3V @ 1.2A.....	3.82
Pri. 115/230V—Sec. 11V @ 15A-25KV Insul.....	48.00
Pri. 115/230V—Sec. 9VCT @ 35A.....	7.65
Amertran—5V @ 190A—35KV Insul.....	19.50
6.3VCT @ 5A, 6.3VCT @ 2A, 6.3VCT @ 2A, 2 1/2VCT @ 5A, 2 1/2VCT @ 5A.....	4.77

GENERAL ELECTRIC AMPLIDYNE Motor-Generator

Consists of G.E. 1HP 115V 1 ph 60 cy 11.5A 3450 RPM continuous duty motor coupled to G.E. model 5AM65FB31 250V DC 2A 0.5KW 3450 RPM Amplidyne generator.

Brand New \$107.50

ELECTRONIC RESEARCH LABORATORIES
1021-A CALLOWHILL ST. PHILA. 23, PA.
Telephones - MARKET 7-6590 and 6591

OCT. SPECIAL
WESTINGHOUSE
2" 0-500
MICROAMP
PANEL METER
BAKELITE CASE
(VOLT SCALE)
\$2.95 ea.

PEAK ELECTRONICS CO.

COMPONENTS

SELECTED AND GUARANTEED SURPLUS AT A FRACTION OF ORIGINAL COST.
 188 WASHINGTON ST., NEW YORK 7, N.Y.

OCT. SPECIAL
POWER TRANS.
740 Volts CT.
185 Mills
6.3V @ 5A, 5V @ 4A
HALF SHELL
\$3.49 ea.

POWER TRANSFORMER
 550 volts CT, 125 ma. 5 V. @ 2 A.
 6.3 V. @ 4A, Pri. 117 V 60 cy. Fully
 cased\$1.95 ea.

POWER SUPPLY KIT
 Uses transformer described & illustrated
 plus (1) 150 ma. choke (1) dual oil
 capacitor, (1) socket. All for only
\$2.99

POWER TRANSFORMER
 Pri. 110 V 60 cy. Sec. 880 V CT @ 100 ma. 6.3 V.
 @ 4 A, 5V @ 3 A. Hermetic. Seal.....\$2.49 ea.

POWER TRANSFORMERS
 Hermetically sealed. Pri 110 volts 60 cy.
 940 volts CT, 125 MA, 6.3V 8A, 6.3V, 2.5A,
 6.3, 1.2A, 6.3V, .5A, 5V, 3A..... 3.95 ea.
 1110 volts CT 60 MA, 920 volts CT 160 MA,
 6.3V, 18A, 6.3V, 1.25A, 5V2A, 5V2A..... 4.95 ea.
 300 volts CT 300 MA, 2.5V7A, 2.5V7A,
 0.3V, 1.5A..... 2.75
 1050 volts @ 20 ma, 20V, 4A, 2.5V, 5A..... 2.75

CHOKES BARGAINS

6 Henry 50 Ma 250 Ohms, open frame.....	3 for .99
6 Henry 80 Ma 220 Ohms, open frame.....	.68
8 Henry 150 Ma 140 Ohms, open frame.....	.99
8 Henry 175 Ma 120 Ohms, fully cased.....	1.49
6 Henry 400 Ma 97 Ohms, fully cased.....	3.69
4.3 Henry 445 Ma 39 Ohms, fully cased.....	4.25
10 Henry 350 Ma 125 Ohms, tapped, full case	2.95
20 Henry 36 Ma 350 Ohms, fully cased.....	.69
12 Henry 250 Ma 190 Ohms, fully cased.....	2.00
5 Henry 170 Ma 110 Ohms, fully cased.....	1.35

HIGH CURRENT MICAS
 Type G4 Ceramic Case 5 3/4"
 High, 5" Diameter Tolerance
 5% or Better.

CAP	Amps	KV	Price	CAP	Amps	KV	Price
MFD	1 Mc	DC	Each	MFD	1 Mc	DC	Each
.08	60	4	\$27.50	.009	40	15	\$25.50
.1	70	4	29.50	.01	43	15	29.50
.65	60	5	24.50	.0047	32	15	24.50
.037	45	6	26.50	.0031	26	20	29.50
.02	40	9	29.50	.004	30	22	33.50
.02	55	10	29.50	.0093	25	25	35.50
.0117	40	14	24.50	.001	12	30	26.50
.0075	39	15	24.50	.0005	9	30	26.50

TYPE G1

.00024	4	6	3.95
.0003	4	6	3.95
.0005	5	6	3.95
.001	7	6	4.95
.002	11	6	4.95

TYPE G2

.001	10	10	5.95
.002	13	10	5.95
.005	25	7	6.95

PANEL METER KIT

Consists of:

- 2" 0-50 Ma, Gov't Surplus Meter, Square Case.
- 4 Scales for the following Ranges:
- 0-50 Ma, 0-100 Ma, 0-200 Ma, 0-500 Ma.
- Precalculated Shunt Sizes.
- Complete Data and Instructions.

All for \$2.50

BAKELITE CASED MICAS

MMF	VDC	Price	MMF	VDC	Price
D .001	600	\$.18	C .002	3 KV	.95
E .01	600	.26	D .005	3 KV	.70
D .02	600	.26	C .005	3 KV	1.24
E .027	600	.26	D .008	3 KV	1.50
C .01	1 KV	.45	D .002	3 KV	.70
D .02	1200	.35	C .0001	5 KV	.70
C .024	1500	.65	C .0005	5 KV	.85
C .033	1500	.75	C .0015	5 KV	1.60
C .015	2 KV	.80	C .003	5 KV	1.90
C .02	2 KV	.90	C .005	5 KV	2.50
D .002	2500	.45	C .002	6 KV	2.90
E .005	2500	.55	B .002	8 KV	5.95
C .025	2500	1.25	B .0005	8 KV	2.90
C .001	3 KV	.90	B .0012	8 KV	4.50

SCR 522 TRANSMITTER RECEIVER
 Complete with tubes and separate Dynamotor Power Supply. Excellent condition\$36.50

MOTOR & GEAR BOX
 Type RL42B, Motor 24 Volts DC, 1/8 HP—1 min. with Gear Reduction Box.....\$2.25 each

NON INDUCTIVE RESISTORS

250 Ohm 100 Watt.....	.75
500 Ohm 100 Watt.....	.75
12500 Ohm 150 Watt.....	.95

METER MULTIPLIERS

2 Meg 1/5 of 1% Cape Enclosed 2 KV.....	\$3.95
2 Meg 1/2 of 1% Tubular 4 KV.....	1.95
4 Meg 1/2 of 1% Tubular 4 KV.....	3.75

HEAVY DUTY CERAMIC RF SWITCH
 Single Pole 11 pos.\$9.95 ea.
 UTC type PA 5000 ohm plate to 500 ohm line and
 6 ohm voice coil. 10 watt. 60 to 10,000 cps +1
 DB.CLOSE OUT AT \$1.99

PRECISION 1% W.W. RESISTORS
 Ohms: 2K, 5K, 8500, 50K, 95K..... .25 ea.

PANEL METERS
BRAND NEW
GOVERNMENT
SURPLUS

2" Simpson 0-200 microamp, Mile scale.....	\$4.50
2" Simpson 0-5 Ma, Basic, square.....	2.25
2" GE 0-5 Ma, amp. scale.....	1.95
2" Simpson 0-20 Ma, amp scale.....	1.75
2" Sun 0-25 Ma, 0-100 scale.....	1.75
2" GE 0-50 Ma.....	2.45
2" Sun 0-50 Ma, 0-100 scale, square.....	1.95
2" GE 0-250 Ma, AC.....	2.95
2" GE 0-1 amp RF, internal thermo.....	1.95
2" Simpson 0-2 Amp RF, internal thermo.....	1.95
2" GE 0-4 amp, internal thermo.....	1.95
2" Westinghouse 0-9 AMPRF, int. thermo.....	3.95
2" Sun 0-20 volts DC.....	1.75
2" Weston 0-20 volts DC.....	2.45
2" GE 0-30 volts DC 1000 ohms per volt.....	2.75
2" GE 0-25 volts AC, 0-100 scale, Linear.....	2.95
2" Triplett 0-300 volts AC.....	2.95
2" GE 0-30 AC DC.....	1.95
2" WESTON 0-2 UA Mod. 301, spcl scale.....	12.95
2" WESTON 0-0-40 UA Mod. 301, spcl scale.....	8.75
3" GE 50-0-50 microamps square.....	8.75
3" GE 6-75 Microamps Sq.....	9.95
3" McClintock 0-1 Ma 10-10 scales.....	4.50
3" Westinghouse 0-1 MA (KV scale).....	4.50
3" Westinghouse 0-2 MA.....	3.95
3" Simpson 0-2 MA.....	3.95
3" GE 0-5 Ma square.....	3.95
3" Westinghouse 0-10 Ma (Amp scale).....	2.75
3" GE 0-10 Ma, square.....	3.95
3" Westinghouse 0-15 Ma.....	3.95
3" Westinghouse 0-20 Ma.....	3.95
3" Simpson 0-20 MA.....	3.95
3" GE 0-20 Ma, square.....	3.95
3" GE 0-30 Ma, square.....	3.95
3" GE 0-50 Ma, square.....	3.95
3" Western Electric 0-80-Ma.....	2.95
3" GE 0-100 Ma square.....	3.95
3" GE 0-200 Ma square.....	3.95
3" GE 0-300 Ma, square.....	3.95
3" GE 0-1 Amp DC.....	3.95
3" Westinghouse 0-2 Amp. DC.....	3.95
3" GE 0-2 Amps. DC square.....	3.95
3" Weston 0-1 Volt DC.....	3.95
3" Dayton-Acme 0-30 volts DC.....	2.50
3" GE 0-300 volts DC (1000 ohms/v).....	4.50
3" Westinghouse 0-750 Volt DC (1000 ohms/v).....	4.50
3" GE 0-800 volts DC (1000 ohms/v) sq.....	4.50
3" GE 0-15 volts AC square.....	3.95
3" GE 0-300 volts AC square.....	4.95
3" GE 0-3 KV, DC, with Multiplier.....	7.95
3" GE 0-5 KV, DC, with Multiplier.....	8.95
3" McClintock 0-200 micro amp, Meg scale.....	9.95
4" GE 0-200 Micro amp Illuminated scale.....	9.95
4" GE VU Meter, -20 to +3.....	16.95
4" GE 0-300 volts AC.....	5.95
4" GE 0-8 KV DC with Multiplier.....	10.75
6" GE 0-1.5 Amps DC Model 8DB.....	6.50
6" GE 0-15 Amp. DC Model 8DB.....	6.50
6" GE 0-25 amps DC Model 10DB ohms/v.....	6.50
6" GE 0-20 volts AC, model 8AB.....	6.50
6" GE 0-12 KV DC, with Multip., Mod. 8DB.....	11.95

LINK TEST SET
 Type #1410. Contains two 3 1/2" meters—a 75-0-75
 microamp Galvanometer and a 0-1 MA multi-scale
 meter. Has tap switch for changing range. Ranges
 are as follows: 75-0-75 microamps, 1 MA 2.5 MA,
 50 MA, 25 volts, 500 volts. Ideal for balancing dis-
 crimators and general lab use. Housed in hard
 wood case with hinged cover. 10" x 8" x 4 1/2".
 Only\$14.95 ea.

MOSSMAN SWITCHES
 4 Pole Single Throw..... .95

GUARDIAN LATCHING RELAY
 Type RC 100. 110 volt 60 cycle coil. S.P.D.T. each
 impulse reverses the position of the contacts. Locks
 automatically. Contacts rated 1500 watts at 110V
 60 cycles. Size 3" long, 2 1/2" wide. 1 1/2" high.
 Only\$1.95 ea.

HIGH WATTAGE ANTENNA RELAY

110/220 volt 60 cycle Solenoid. D.P.D.T. rated at
 5000V. 15A. Heavy duty
 paralleled contacts. Sturdy
 construction. Isolantite In-
 sulation. Base 8" x 10 1/2".

Made by Monitor Controller.....\$18.50
 Same specs. as above but DPST.....12.50
 Same specs. as above but SPDT.....12.50

SENSITIVE RELAY
 Breaks at 3 MA. Beautifully Con-
 structed and delicately pivoted.
 Approx. 2000 ohms resistance.
 Housed in dustproof aluminum
 can. Plugs into 5 prong socket.
 Only99¢ ea.

500 MICROAMP RELAY
 Delicately balanced, S.P.D.T., 10,000 ohm coil
 Trips at .4 to .5 MA, 2 1/2" x 2 1/2" x 1 1/2" high. \$2.95
General Electric Overload Relay. Electrical
Reset 110 Volts 60 Cycle
 Breaks at 640 Milliamps but easily adjustable for
 other currents. Terrific values at only.....\$1.95

SOLA CONSTANT VOLTAGE TRANSFORMER
 2 KVA. 17.4 Amps. Input 95-125 Volts, 60 Cycles,
 1 Phase. Output 115 Volts. Type 4, 3 1/2" long,
 9 1/2" H, 7 7/8" W. Weight 225 Lbs.....\$137.50 each

RAYTHEON SWINGING CHOKES
 2 to 12 Henrys. 1 Amp to 100 Ma, 15
 Ohms DC fully cased. High voltage
 insulation, ceramic insulators. Very
 conservatively rated. Weight 60 Lbs.
 \$14.95 ea.

THORDARSON PLATE TRANSFORMER
 CHT Series, Model T15P 22. 110/220 volt 60 cy.
 Primary: 3500V, 3000V, 2500V, 2000V C.T. Sec-
 ondary: 625 watts. Weight 70 Lbs.....\$22.50 ea.

SCOPE AND FIL. TRANSFORMER

Pri. 115 volts, 60 cycles, Sec.
 4400 volts RMS 4.5 MA., 5 volts.
 CT 3 amps. Fil. Ins. 15 KV.
 RMS test. Hermetically sealed.
 Has insulated plate cap for rec-
 tifier. Made by Raytheon. 4 1/2 x
 5 x 5 1/2.....Only \$4.95

Mallory Vibropack Transformer 6 Volt Input. Output
 300 Volts at 100 MA.....\$3.95

WESTINGHOUSE SELENIUM RECTIFIER
 Hermetically sealed. Oil Immersed
 Full Wave Bridge. 30 Volts AC
 Input. 24 Volts at 2 Amps Output.
 Size 2 1/2"x2 1/2"x3 1/2" h.....\$3.75 ea.

50 megohm 35 watt Resistor with mount, \$1.49 each;
 10 for \$9.90. 10 Meg 10 Watts 49¢; 2 Meg 5 Watt 35¢

30 WATT WIRE WOUND RESISTORS
 Ohms: 100-2500-3k-4500-5300-18k.....8 for .99
 Precision 1% Meg. 1% Accuracy Resistor, Non-
 inductive, 1 watt, hermetically sealed in glass
 .25 ea. 10 for.....\$1.90

WIRE WOUND RESISTORS

5 watt ohms: 25-50-200-470-2500.....	.09 ea.
10 watt ohms: 25-40-84-400-470-1325-2K-4K.....	.15 ea.
20 watt ohms: 50-100-300-750-1K-1.5K.....	.20 ea.
2.5K-2.7K-5K-10K-16K-20K.....	.20 ea.

SLIDER ADJUSTABLE RESISTORS

20 Watt: 1, 5, 50 Ohms.....	.25
50 Watt: 100, 500 Ohms.....	.35
75 Watt: 100, 150, 200 Ohms.....	.39
100 Watt: 20, 50, 75, 120, 500 Ohms.....	.49

MIDGET VARIABLE CONDENSERS

15 MMF (HF 15).....	.39
Dual 15 MMF (HF 15 D).....	.69
250 MMF (MC 250 S).....	.69

CERAMICONS

MMF: 1.5, 2, 3, 4, 10, 20, 22, 120, 500..... .05 ea.
 MMF: 10, 47, 50, 60, 340, 750, 780, 1000..... .09 ea.

OIL CONDENSERS

56 mfd 220 vdc-3.95	10 mfd 2000 vdc-4.95
4 mfd 600 vdc-.59	2 mfd 4000 vdc-4.90
6 mfd 600 vdc-.79	4 mfd 4000 vdc-6.75
3/3 mfd 600 vdc-.79	1 mfd 5000 vdc-4.50
8/8 mfd 600 vdc-1.39	1 mfd 7500 vdc-.95
10 mfd 600 vdc-.99	1/1 mfd 7000 vdc-2.25
10 mfd 1000 vdc-2.50	2 mfd 6000 vdc-9.95
2 mfd 1500 vdc-1.25	1 mfd 7500 vdc-6.50
6 mfd 1500 vdc-2.95	.01/.01 mfd 12 kv-5.75
10 mfd 1500 vdc-3.75	2 mfd 7500 vdc-12.75
2 mfd 2000 vdc-2.25	.65 mfd 12,500 vdc-12.95
8 mfd 2000 vdc-3.75	1 mfd 15 kvdc-15.95

FILAMENT TRANSFORMERS
 110 V 60 CY Primaries—Full Casings.

6.3 Volts, 12 Amps.....	\$1.69
2.6 Volt 10 Amp. H.V. Insulation.....	3.49
2.5 Volt CT 21 Amps.....	4.75
5 Volt 4A, 6.3V, 3A.....	2.45
2.5V CT 20A, 2.5V CT 20A.....	6.95

MISCELLANEOUS BARGAINS

2 mfd 250 volts ac oil cond.....	6 for .99
Ceramicon .0005 mfd.....	20 for .99
.01 600 volt dc digital micas.....	10 for .99
.001 600 volt dc digital micas.....	15 for .99
.006 600 volt digital micas.....	12 for .99
Butterfly cond. 2 to 11 mfd ball brngs.....	3 for .99
CD type 4 micas .001 600vdc.....	10 for .99
10,000 ohm potentiometers.....	6 for .99
Var. cond. 150 mmf .07 spacing.....	2 for .99
Variable ceramicon 20 to 125 mmf type 823 S.....	for .99
Western Electric silver variable 5 to 2.5 mmf & for.....	.99
.35 at 16 KV plus 75 at 8 KV Oil Cond.....	3.95
.05 MFD 7500 DC Oil Cond.....	.75
7 MFD 330 VAC Oil Cond.....	.69
25 ohm 675 Watt Rheostat.....	2.95
1 Meg. W.W. 1/5 of 1%.....	1.50 ea.

Portable VHF Communication Unit

Two-way radio telephone equipment designed for operation between 152 and 162 megacycles. Adaptable for many uses, a complete unit including the rechargeable storage battery weighs but fifteen pounds, and is housed in a sturdy case 11 1/2" x 9" x 4 1/4", provided with shoulder straps.

This brand new set of big name manufacture comes complete with battery, battery tray, and handset but less crystal \$89.50. Battery charger is extra at \$19.95.

Mobile VHF Communication Unit

Adaptable for many mobile uses, this is a compact unit 3 1/2" x 8" x 1 1/2" operating on 152 to 162 megacycles. It is six volt powered direct from storage battery, and is complete with the tone filter and crystal; handset, control box, antenna and installation kit. Brand new, ready to go. **\$129.50**

Extra 18" stub type antennae are available **\$2.95**

Condensers

	Each
2 mfd. 4000 VDC. OIL FILLED	\$2.95
1 mfd. 6000 VDC. OIL FILLED	1.98
.25 mfd. 15000 VDC. OIL FILLED	4.95
.00025 mfd. 25000 VDC. OIL FILLED	2.95
.4 mfd. 1500 VDC. OIL FILLED	.29
2 mfd. 600 VDC. OIL FILLED	10 for 2.49
1 mfd. 600 VDC. OIL FILLED	3 for 1.00
1 mfd. 600 VDC. OIL FILLED	5 for 1.00
.1x.1x.1—1200 VDC. OIL FILLED	2 for 1.00
50 mmfd—5KV—5 Amp. Vacuum Cond.	1.19

TEST EQUIPMENT

I 135 Test Set	TS 251
BC 771 Frequency Meter	BC 221 Freq. Meter
BC1287 Scope	I 222 Signal Generator
TS 62/AP	LM Frequency Meters
TS 13/AP	
TS 102A/AP	

RC 150 EQUIPMENT

Receiver BC 1161 A
Transmitter BC 1160 A
Control Unit BC 1162A
Signal Generator I-198A

T-85/APTS UHF TRANSMITTER

Operating over a frequency range of 300 to 1400 MCPC with a nominal output of from 10 to 30 watts. Unit is equipped with 110 V 60 CPS filament transformer; blower; lecher wire test frequency set, and 8 tubes—1-931A; 2-6AC7; 2-6AG7; 1-6L6G; 2-829B; 1-3C22 (GL522) (oscillator).
New in original box with Operating Instruction Manual. **\$69.50**

BC-603 Receiver—Good, Used... **\$24.95**

BC-604 Transmitter FM 20-26 MC 11 and 15 meters. Can be operated on 10 meters-10 channel push button crystal. With all tubes and meter but less dynamotor. Excellent condition **\$14.95**
Crystals—Set of 80 **14.95**

IS-185 Weston Voltmeter Model 433 0 to 150 VAC, 25 to 2400 cycles. New **\$24.95**

Miscellaneous Specials

1D6/APN4 - Scope
R78/A PS 15 - Scope
R7/AP5 2 Receiver and Scope
ASB7 Scope
SCR 522 Receiver-Transmitter
MN26 C- or Y Receiver
RA 10 Receiver
BC 639 Receiver }
RA 42 Rectifier }
TA2J24 Transmitter
SCR 269 G Compass Installation
ARN7 Compass Installation
MN 26 Compass Installation
ILS Installation (BC733 & R89)
R 132/TPS10 Radar Receiver
MD22 - URA/T1 Modulator
AN/APRI Receiver and Tuning units
ASB 7 Complete Radar Installation
BD 71—6 position Field Switchboard
EE8 Field Phones
RM 29 Remote Phone Control
SCR 183 complete
ARC/1 Transceiver
ART 13 Transmitter
BC348 Receiver
RTA1B Transceiver
Model 15 Radar Trainer
BC-906-Frequency Meter

PRICES OF ABOVE UPON REQUEST

ARROW has the VALUES!

RADIO EQUIPMENT R. C.-100-B

This equipment made by General Electric, was designed for ground use as an identification of friendly aircraft.

Radio equipment RC-100-B consists of Cabinet CH-118 in which are mounted Transmitter BC-769, Keying unit BC-770, Radio Receiver BC-768, Rectifier RA-52, Wave Trap FL-25, wiring and Blower. Additional equipment consists of Antenna unit AN-82B; Transmission line MC-377, air compressor M-349, Oven M-348, control box BC-773, Amplifier BC-783B and associated cords and hardware.

Primary requirements are 110 to 120 volts, 50 to 60 cycle for the entire unit and accessories.

Cabinet CH-118 is of the Standard 19 inch rack type structural steel frame with runner angles for each of the units. A full length access door with safety interlocks forms the rear of the cabinet.

Transmitter BC-769 is designed to transmit RF pulsed signals at 470 megacycles with the use of two type 15E Tubes operating in push-pull with resonant grid, plate and filament lines.

Keying unit BC-770 furnishes the pulse of the Transmitter.

Receiver BC-768 was used to detect the 493.5 megacycle reply pulses from the interrogated station and to sufficiently amplify these signals for oscilloscope observation.

Rectifier RA-52 produces the high voltage. An 0-15 kilovolt DC Meter is connected across the output of the filter to measure the voltage fed to transmitter BC-769, while an 0-20 milliammeter is connected to the ground return to measure the average current drawn.

Antenna AN-82B consists of 24 vertically polarized, half wave radiating elements, a reflecting screen, open-wire transmission line sections and a concentric-line terminating section or elevator.

Wave trap FL-25 is used to separate received and transmitted signals.

Transmission line MC-377 is of 1/8 inch air-dielectric, 70 ohm concentric line type and is assembled by means of solderless air tight connectors.

Control Box BC-773 contains necessary controls for operation.

Amplifier BC-783-B is used to amplify the output of Receiver BC-768 for suitable oscilloscope presentation.

Air Compressor M-349

together with 12 feet of 1/4 inch soft copper tubing and necessary hardware is used to fill and maintain transmission lines with dry air under pressure. Operation is direct from 110 V AC 60 Cycles.

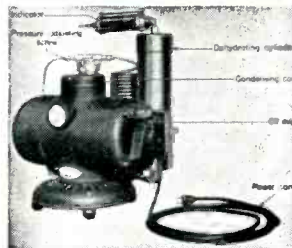

Oven M-348

is furnished for removal of moisture from the dehydrating cylinders of the compressor. It too operates from 110V AC 60 cycles.

Frequency Meter BC-771

Frequency Meter BC-771 is used for frequency checking and for tuning operations on Radio Transmitter BC-769 and Radio Receiver BC-768. It is a separate unit mechanically and has its own power supply, which requires a 110 to 120 Volt, 50 to 60 cycle source.

The circuits consist of an r-f oscillator, a crystal oscillator, a 30,000 cycle oscillator and associated mixer, multiplier, and amplifier tubes. The crystal oscillator is used to set the r-f oscillator to exactly 94 or 98.7 megacycles.

For tuning Radio Transmitter BC-769 to 470 megacycles, the signal from the radio transmitter is mixed with the fifth harmonic of the r-f oscillator, operating at 94 megacycles, to produce an audio-beat frequency. For tuning Radio Receiver BC-768 to 493.5 megacycles, the fifth harmonic r-f oscillator, operating at 98.7 megacycles and modulated by the output of the 30,000 cycle oscillator, is fed into the radio receiver.

The entire RC 100 as described above—
all brand new—complete—

Technical Manual TM11-1113B is furnished
with the complete set.

\$595.00

F.O.B. Warehouse

Prices on individual components will be furnished on request.

ARROW SALES, Inc.

Dept. 25

4712 W. S. Michigan Ave., Chicago 16, Ill.

PHONE: MArtoon 7-9374

All items FOB warehouse. 20% Deposit required on all orders. Minimum order accepted—\$5.00. Illinois residents, please add regular sales tax to your remittance.



CONDENSER SPECIAL

5—5mfd—400 vdc Oil Cond.

3 terms, bot. mnfts flanged type. Dims. 3 1/4 x 3 1/2 x 2. Tested at 1800v. Meets commercial specs. for 600v. operation up to 40 degrees C. Currently being used for power factor correction. Numerous applications for this high quality condenser. See symbol "F".

Price \$.55—CARTON of 24 \$4.5

OIL CONDENSERS—New

Symbol	Capacity	Voltage	Type	Price	Symbol	Capacity	Voltage	Type	Price
B	.001	50KV	#14F112	\$30.00	B	1	10KV	#14F267	14.95
B	.005-.005-.01	10KV	#26F344	3.50	B	1	15KV		17.75
B	.01	3000V		.50	B	1	20KV		28.75
Special	.02	20KV		10.50	B	1.75	450V	#14F35	.25
E	.03	18KV	#26F380	7.75	D	2	600V		.33
B	.05-.05	2000VAC		.95	B	2	600V	#26F407	.38
B	.1	1500V		.28	G	2	600V	TLA	.16
B	.1	2000V	1 Term	.32	G	2	1000V		.55
F	.1	2500V		.40	G	2	1000V	TLA	.55
B	.1	3500V		.55	B	2	2500V		2.50
G	.1	7000V	1 Term	.95	B	2	4000V	#23F47	3.95
E	.1	7500V	#25F475	.85	B	2-2	600V		.65
B	.1	7500V	26F469	1.35	B	3	600V	Can	.39
B	.1	10KV	#23F644	6.95	B	3	4000V		5.25
B	.1	15KV	#25F572	10.95	B	3-3	150V		.25
B	.1	25KV	#14F52	20.95	B	3-3	600V		.70
B	.2	10KV	#25F433	7.95	B	4	440VAC		.78
B	.25	3500V		1.30	R	4	500V	#26F796	.55
E	.25	6000V	#23F659	1.25	B	4	600V	#23F317	.69
B	.25	20KV		19.95	G	4	600V	TLA (2) Terms	.69
B	.4	10KV		8.95	G	4	600V	TLA	.69
D	.5	400V		.14	B	4	1000V		1.15
D	.5	500V		.16	B	4	3000V		5.25
F	.5	600V		.24	B	5	600V		.59
G	.5	1500V		.29	B	5	1500V		2.75
B	.5	2000V		1.25	B	6	600V		.74
B	.5	3000V		1.65	B	7	600V		.79
B	.5	25KV		29.95	R	7	800V		.89
B	.5-1	2000V		.89	R	8	600V		.95
B	.5-5	600V		.24	O	8-8	600V		1.20
B	.65	12.5KV		10.75	F	8-8	600V		.90
D	.75	1000V		.22	B	10	600V		1.10
F	1	400V		.18	B	10	1000V		2.50
D	1	500V	#23F266	.24	B	10	1500V		2.95
F	1	500V	#23F225	.24	B	13.5	220VAC		.90
F	1	600V	CP68S1EF105	.28	B	15	600V	#25F472	1.25
B	1	600V		.24	B	15	1000V	TJ30040	2.65
B	1	1000V		.30	B	42	600V	#25F673	4.95
B	1	2500V	#23F121	1.25					

CERAMICON CONDS.

10, 56, 100, 500, 1000 and 5000 mmfds @ \$5.00 per "C"

NEW SILVER MICA CONDS.

10 mmfd to 950 mmfd	.08
1000 mmfd to 6000 mmfd	.09
10,000 mmfd	.12
mmfd mmfd mmfd mmfd mmfd mmfd mmfd	
10 300 50 500 120 1000 200 5000	
20 345 51 870 140 1500 240 6000	
25 350 60 900 150 2000 250 10,000	
30 z 400 100 950 180 2500 280	

Special Silver Mica Kit—100 @ \$5.95

MOLDED PAPER CONDS.

.004, .01, .03—600V @ \$4.50 per "C"
.01, .03, .05—400V @ \$3.50 per "C"
.01—1000V @ \$10.00 per "C"

NEW MICA CONDS.

6 mmfd to 750 mmfd	.04
1000 mmfd to 6000 mmfd	.045
10,000 mmfd	.06
mmfd mmfd mmfd mmfd mmfd mmfd mmfd	
6 350 39 600 140 1500 240 5100	
10 390 50 750 150 2200 250 6000	
15 400 75 1000 185 3800 300 10,000	
25 500 100 1250 200 5000	

Special Mica Kit—100 @ \$2.95

Price F.O.B., 25% with order. Balance C.O.D. Minimum order \$2.00.

PRICES SUBJECT TO CHANGE WITHOUT NOTICE.

MONMOUTH RADIO LABORATORIES
BOX 159 OAKHURST, N. J.

\$59.50 ELECTRONIC RADIO ALARM
Make it Secure

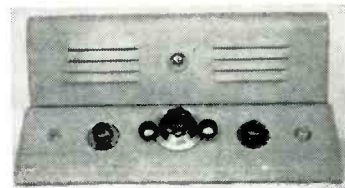

Guaranteed new, functionally perfect and designed by a leading manufacturer. Uses balanced bridge principle. Intrusion operates any external alarm system. (Bell, horn, light, etc.) Automatic reset. Protects any ungrounded object, room or bldg. (Safe, cabinet, window screen, screening under window or door. Protection against injury by high voltage, hazardous equip and locations. Added feature includes built in fire detector. Operates alarm at 160 deg. F. Complete with instructions.

TYPE "J" POTS \$5.00

SYMBOLS: LS—Locking Type Shaft
S—Screwdriver, R—Round

Ohms	Shaft	Ohms	Shaft
50	1/4 S	20,000	1 1/4 R
200	1/8 LS	25,000	3/8 R
1000	1/8 LS	25,000	1/8 LS
1000	1/4 S	25,000	1/8 S
2000	3/8 LS	50,000	1 5/16 R
2500	1/2 R	50,000	1/8 S
2000	1/8 LS	50,000	1/4 S
3000	1/8 LS	50,000	1/8 LS
3000	1/2 R	100,000	1/8 LS
5000	1/8 S	100,000	1/2 R
5000	1/8 LS	100,000	1.0 R
10,000	1/4 S	100,000	1/8 S
10,000	3/8 R	150,000	2 1/8 R
10,000	1/8 LS	200,000	9/16 R
10,000	5/16 S	250,000	1/8 S
15,000	1/8 S	300,000 (2 Terms)	1/8 S
15,000	1 1/8 R	1 Meg	1/8 S
20,000	3/8 S	1 Meg	1/8 LS
20,000	1/8 LS		

TYPE "JJ" \$1.00

2K	3/8 R	10K-50K (10K 2 terms.)
1K-5K	3/8 R	1/2 R
100K	1/2 R	

25 WATT RHEOSTATS

Ohmage	Shaft	Price	Ohmage	Shaft	Price
Dual 1.3	1/8 S	\$.98	225	1/8 LS	.65
15	1/2 R	.45	250	1/2 with knob	.59
20	1/2 R	.45			
25	1/2 R	.45	300	1/2 with knob	.59
50	1/8 S	.45			
Dual 50	1/2	.98	500	1/4 S	.55
75	1.0	.45	500	1/3 S	.55
100	1/2	.55	1500	1/2 S	.65
125	1/2 S	.55	2000	3/8	.65
175	1/2 with knob	.59	2500	1/2	.65
			5000	1 1/4	.65
225	1/4 S	.59	5000	1/8 S	.65

BAKELITE TOGGLE SWITCHES

SPST 3A. 250V, 7/16" Bushing, Ball Handle (On-Off)	.18
SPST 3A. 250V, 3/4" Bushing, 1/2" SD shaft	.18
SPDT Type C-H 8800 K4, 7/16" Bushing, Ball Handle (On-Off-On)	.34
DPST 3A. 250V, 7/16" Bushing, Bat Handle	.30
DPST Type C-11 8823K4, 7/16" Bushing, Bat Handle	.35
DPDT 3A. 250V, 7/16" Bushing, 3/4" Shank, 1/2" Ball Handle	.44
DPDT Type C-H 8824K4, 7/16" Bushing, Bat Handle	.48

COAX CONNECTORS

83-1SP	\$.28	83-1J	\$.64
83-1SPN	.28	83-1R	.28

FREQ. METER

Type BC—906 C
150—225 megacycles. Brand new. Boxed.
Price \$11.95

MILLIONS OF RESISTORS

1/2-1.2 Watts

FOR THOSE IMMEDIATE REQUIREMENTS

LIFE ELECTRONIC SALES

91 Gold St. DI 9-4154 N. Y. 7, N. Y.

CLOSE OUT SURPLUS LABORATORY EQUIPMENT

Boonton

- 2—140-A Beat Frequency generator. Each \$445.00
- 9—120-A V.H.F. Circuit Checkers (3 Ranges —27-210 MC) for TV & FM. Each 95.00
- Entire lot of 9 units. 450.00
- 1—Clough-Bregle 230A AC Bridge (A.C. volts, capacity, turns ratio). 35.00
- 1—Industrial Instruments MB-8 0-1000 MEG Bridge 40.00
- 1—Weston 796 Megohmmeter 0-20, 200 Meg-ohms 50.00
- 1—Weston 45 D.C. Volt Meter 0.1% ACC. 40.00
- MISCELLANEOUS
- 3—W. E. TSS/AP Range Calibrators. Each 35.00
- 7—Boston Gear 150 LBT Gear Reduction Turntables 150:1 New. Each 10.00
- 1—Shalfeross 621H Per Cent Limit Bridge AS 25.00
- 1—W. E. Synchroscope 95.00
- 1—W. E. TS/19APQ5 Range Cal. Modulator 25.00
- 1—Sylvania Pirani Tube #R1110. 10.00
- Entire lot above; write for price.

LINEAR EQUIPMENT LABS—5MC OSCILLOSCOPE—BRAND NEW 169.50

Write for complete details

THE NATIONAL INSTRUMENT CO.
21 Cathay Road East Rockaway, N. Y.
Telephone Lyn. 9-10116

Important Announcement

TO ALL USERS OF RESISTORS
IN OUR INDUSTRY...

SOME MONTHS AGO we mailed a letter to all our customers and potential customers about resistors—sorry cannot mention the name.

The letter tells the story about resistors — — — a true story — — —. We know we cannot fill all orders for resistors from stock. We also regret that the difficulty in getting these resistors increases prices so much that we often refuse to buy these components.

Although we are a small company we promise to do everything possible to the end that this shortage shall not affect your production schedules. We do not use excuses but we do tell all the true facts about our delivery potential.

We thank all of you for confidence expressed in hundreds of orders coming daily and we promise to do all possible to fill these orders in the near future.

Please do not hesitate to mail us your orders—we will try to fill them all—altho there may be delays.

Thanking you for your very valued patronage, we are

Very sincerely yours,



Legri S Company Inc.
130 W. 102nd St.
New York 25, N. Y.
Gregory Grinn, President

NEW YORK'S RADIO TUBE EXCHANGE

TUBES TUBES TUBES

We have one of the largest stocks of
radio, klystrons, magnetrons,
power and special tubes.

Contact us for your requirements.

TEST EQUIPMENT

- Microwave K Band 2400 MC.
- TSK1-SE Spectrum Analyzer
- K Brand Flap Attenuator
- X Band**
- TSX-1SE Spectrum Analyzer
- TS 12 Unit 1 USWR Measuring Amplifier, 2 channel
- TS 12 Unit 2 Plumbing for above TS13
- TS16AA VSWR Measuring Amplifier Navy type TS 12 Unit 1
- TAA-11BL VSWR Measuring Amplifier, Browning
- TS 33 X Band Power and Frequency Meter
- TS 35 X Band Pulsed Signal Generator
- TS 36 X Band Power Meter
- TS 45 X Band Signal Generator
- TS 146 X Band Signal Generator
- TS 263 Navy Version of TS 146
- TS 108
- X Band Magic T Plumbing
- X Band Tunable Crystal Mounts
- TVN-8SE MIT Klystron pulse and power Supply
- S Band**
- TS3A/AP S Band Power and Frequency Meter
- RF 4 Electrically Tuned S Band Echo Box
- BC 1277/60ABQ S Band Pulsed Signal Generator
- PE 102 High Power S Band Signal Generator
- L Band**
- Hazeltine 1030 Signal Generator 145 to 235 Megacycles
- TS 69, 300 to 1000 MC Frequency Meter
- Measurements Corp. type 84 Standard Signal Generator
- TS 47, 40 to 400 MC Signal Generator
- Broadcast Wave Bands**
- 162C Rider Chanalyst Short Wave Adapter for 162C
- Ferris 22A, Signal Generator
- TS 174 Signal
- Oscilloscopes**
- BC 1287A used in LZ sets
- TS 34 Oscilloscopes WE
- Supreme 564
- Audio Frequencies**
- RCA Audio Chanalyst
- Hewlett Packard
- Other Test Equipment and Meters**
- TS 15/A Magnet Flux Meter
- General Radio V T Voltmeter 728A
- Calibrator WE 1-147
- Hazeltine Pulse & Sweep Generator
- UHF Radio Noise & Field Strength Meter Measurements Corp type 58
- General Radio 1000 cycles type 213
- Limit Bridges
- Boonton Standard Inductances
- Weston Meters types 430, 429, 741
- Model 40 Pyrometer
- Rawson, meters 0-10 Microampere 0-2 Millivolt
- RADAR Sets & Parts
- APS 3-APS 4-SCR 284
- R-111/APRSA Receivers



PHONE WORTH 4-8262

135 LIBERTY ST., NEW YORK 6, N.Y.

400-800 CYCLE SURPLUS EQUIPMENT

POWER UNIT PV-6/TPS-1

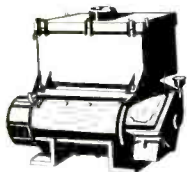

Gasoline driven 2 cycle engine. Dual voltage generator: 120 VAC; 1400 watt; 400 cycle; 28 VDC; 14.3 amp.

BRAND NEW... \$175.00

INVERTER UNIT PE 218

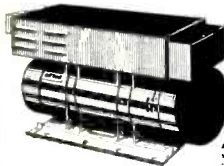

Output: 115 VAC; single phase; PP 90; 380/500 cycle; 1500 V.A. Input: 25-28 VDC; 92 amps; 8000 mm; Exc. volts 27.5; Leland Electric mfg.

BRAND NEW... \$29.95

TCS Marine Receiver & Transmitter

Complete with all tubes and power supply.
BRAND NEW... \$250.00

Amplifier Unit (Pioneer)

12071-1A; 400 cycle; 115 Volts; 400 cycle; 26 Volts
BRAND NEW... \$12.95

ALL EQUIPT. FDB. PASADENA • PLEASE SEND FULL AMT. WITH ORDER!

ONAN MOTOR GENERATOR SET MG 075-G-1

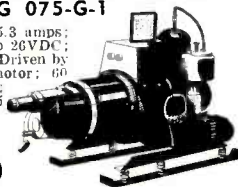

Generator 115VAC; 5.3 amps; 6 KW; PF 1.0; Also 26VDC; 100 Watt; 3.8 amps. Driven by 115-230 VAC 2hp motor; 60 cycle; single phase; 3450 RPM; 21.10.5 amps.

BRAND NEW \$195.00

GENERATORS—(Eclipse-Pioneer)

716-3A (Navy Model NEA-3A). Output: 115 VAC; 10.4 amps; 800 cycle; single phase; 28.6 VDC; 60 amps @ 2400 rpm; spline drive; self exciting; wt. 60#. In original box.



BRAND NEW \$29.95

400 Cycle Generators

Homelite 18A120D28-1; 400 cycle out at 1 phase; 115 V; 39 amps; Also a d.c. output of 28 V. and 17.9 amps.

Used, Good... \$100.00

Onan Electric Plant

120 VAC; 1200 watt; 10 amp; 800 cycle; single phase; driven by 2 cyl.-4 cycle gasoline engine.

Like New... \$179.00

C and H Sales Company

BOX 356-E EAST PASADENA STATION • PASADENA 8, CALIFORNIA

CALLING ALL ENGINEERS!

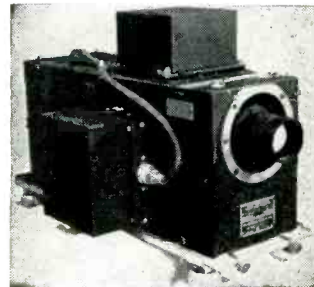

TELEVISION CAMERA

3350 line resolution. Easily converted to present RMA standards. Circuits available with camera. Complete, like new.

We Have: APS-4 & APS-6 Radar

WE ARE LOOKING FOR: ALL TYPES OF
RADAR, GROUND and AIRCRAFT RADIO
EQUIP.

We Want: BC-348 ART-13
ARC-1 RTA-1B
MN 62 R5A/ARN7
BC-1000

TELL US: WHAT YOU HAVE.

TELL US: WHAT YOU NEED.

COLUMBIA ELECTRONICS LTD.
524 S. SAN PEDRO ST.
LOS ANGELES 13, CALIF.
Cable Address: COLLECT

CAN'T KINK

3 cond. 5/16" d.a. Tough rubber cov. cable. For remote or Ant. Control-Foot switch etc. Cut to your order Min. 50 ft. 3 1/2¢ ft. 550 ft. Metal reels Express Collect. \$15.00

RCA 100A

Free Floating Cone Type-Magnetic-Loud Speaker. Removed from rooms of a large N. Y. Hotel. Original cost \$32.00. 3 for \$5.00

- W.E. 24 & 12 volt Telephone lamp. doz. \$1.50
- C/H 4 pole 35 ampere 115v. AC relay. \$4.90
- 3 ampere G.E. Mercury Switch 3/4" glass tube. 3 for \$2.50

GRAIN OF WHEAT LAMPS



Used for illuminating meters, compass, dials, airplane instruments, etc. Soldering iron removes lamp from base to use in models, doll houses, miniature trains, Xmas trees, etc. Mazda G.E. 323 Mazda G.E. 328 3V. 19.A 6V. 2A

Either type, doz. \$1.80

MARKTIME 5 HOUR SWITCH



A 10 amp. timing device. Pointer moves back to zero after time elapses. Ideal for shutting off radios and TV sets when you go to bed. Limited supply at this special PRICE. \$3.90

Also available in 15 min.-30 min.-1 hr. at \$5.90

ISOLATION TRANSFORMER \$1.95

Nat. known Migra. 50 watt 2 windings, 115 V. to 115 V. 60 cy. Ideal to prevent shocks from small radios and medical and electronic devices. Shipping weight 5 lbs.

Other sizes and 220-110 in stock. Kilowatt Demand Meter Totalizer containing heavy duty TELECHRON B-7, 1 RPM motor and hundreds of watch size gears, clutches, springs, etc. Shipping weight 2 lbs.

- 5 for \$10.00 \$2.50
- RDAR MAGNETS \$5.00 to \$17.50
- DPDT 6 volt Battery D.C. 10 ampere Relay \$1.95
- DPDT H&H Toggle Switches 2 for \$4.50
- 10 for \$4.50

NEW HOLTZER-CABOT TOTALLY ENCLOSED MOTORS

50 R.P.M. Reversible Single Phase Capacitor-Run type. 115 Volts AC 60 cycle 0.3 Amp. Torque 100 oz. inches. 4 3/4" shaft 3/8" dia.

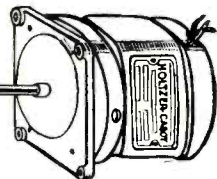

\$17.50 each

GONIOMETERS CFT-47263 in stock CFT-47372

We are Authorized Wholesalers for Micro Switch Corp. and carry the largest stock of Allen-Bradley Solenoids. Potter & Broomfield Relays. Guardian Electric Co. Solenoids and Relays and Hayden Clock Motors in all speeds. Electric Counters.

EST. 1923 **BLAN** EST. 1923

Experimenters and Inventors Supplies 64 Dey St., New York 7, N. Y.

McColpin Christie

RECTIFIERS

model MH 24-25 list price \$215.00

SAVE OVER 75% OUR PRICE \$49.50

BRAND NEW — ORIGINAL PACKAGING

input—230 volts, 3 phase, AC output—24-28 volts, 25 amps DC

Copper sulphide type. Heavy duty. Produces 6 phase, full wave, smooth DC. Less than 2% ripple. Will withstand shocks and momentary overloads. Size 13" x 13" x 19". Weight 85 lbs.

LEO SAGAL CO.

437 CLOVERDALE AVE. LOS ANGELES, 36, CALIFORNIA

SELENIUM RECTIFIERS

and ASSOCIATED COMPONENTS

SINGLE PHASE

Full Wave Bridge

Input: 0-18 VAC Type No.	Current	Output: 0-12 VDC Price
B1-250	250 Ma.	\$.98
B1-1	1.0 Amp.	2.49
B1-1X5	1.5 Amp.	2.95
B1-3X5	3.5 Amp.	4.50
B1-5	5.0 Amp.	5.95
B1-10	10.0 Amp.	9.95
B1-20	20.0 Amp.	15.95
B1-30	30.0 Amp.	24.95
B1-40	40.0 Amp.	27.95
B1-50	50.0 Amp.	32.95

Input: 0-36 VAC Type No.	Current	Output: 0-26 VDC Price
B2-150	150 Ma.	\$.98
B2-250	250 Ma.	1.25
B2-300	300 Ma.	1.50
B2-2	2.0 Amp.	4.95
B2-3X5	3.5 Amp.	6.95
B2-5	5.0 Amp.	9.95
B2-10	10.0 Amp.	15.95
B2-20	20.0 Amp.	27.95
B2-30	30.0 Amp.	36.95
B2-40	40.0 Amp.	44.95

Input: 0-115 VAC Type No.	Current	Output: 0-90 VDC Price
B6-250	250 Ma.	\$ 2.95
B6-600	600 Ma.	5.95
B6-750	750 Ma.	6.95
B6-1X5	1.5 Amp.	10.95
B6-3X5	3.5 Amp.	18.95
B6-5	5.0 Amp.	24.95
B6-10	10.0 Amp.	36.95
B6-15	15.0 Amp.	44.95

Full Wave Center Tap

Input: 10-0-10 VAC Type No.	Current	Output: 0-8 VDC Price
C1-10	10.0 Amp.	\$ 6.95
C1-20	20.0 Amp.	10.95
C1-30	30.0 Amp.	14.95
C1-40	40.0 Amp.	17.95
C1-50	50.0 Amp.	20.95

THREE PHASE

Full Wave Bridge

Input: 0-234 VAC Type No.	Current	Output: 0-250 VDC Price
3B13-1	1.0 Amp.	\$ 22.00
3B13-2	2.0 Amp.	32.00
3B13-4	4.0 Amp.	56.00
3B13-6	6.0 Amp.	81.50
3B13-10	10.0 Amp.	105.00
3B13-15	15.0 Amp.	120.00

RECTIFIER MOUNTING BRACKETS

For Types B1 through B6, and Type C1 \$3.35 per set For Types 3B. 1.05 per set

D-C PANEL METERS

Attractive, rugged, and reasonably priced. Moving Vane solenoid type with accuracy within 5%. Square case. 0-6 Amperes DC 0-12 Amperes DC 0-15 Volts DC Any range \$2.49 each

CATALOG

Write for our Catalog No. 719, which lists additional Selenium Rectifiers, associated transformers, condensers and filter chokes.

All prices FOB our NYC warehouse. Send M.O. or Chk. We will ship transportation charges collect. Rated concerns send P.O. Terms Net 10 days.

POWER SUPPLIES

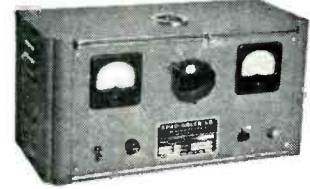

GENERAL PURPOSE Low voltage DC power supplies, with variable outputs. Rugged—Dependable—precision control.

Features

- ✓ Long life Full Wave Selenium Rectifiers
- ✓ Output Voltage Continuously Adjustable from Zero to Maximum
- ✓ 3" Voltmeter and Ammeter 2% acc'y.
- ✓ Stepless Control
- ✓ Instant Power—No Warm-Up Period
- ✓ Assembled and Ready to Operate
- ✓ For 115 VAC 60 Cycles
- ✓ Dimensions 8 1/4" x 16 3/4" x 8"

Write for descriptive bulletin GPA

Model	Voltage	Current	Price
GPA810	0-8 VDC	10 Amps.	\$69.50
GPA1210	0-12 VDC	10 Amps.	75.00
GPA2810	0-28 VDC	10 Amps.	85.00

RECTIFIER CAPACITORS

Model	Volts	Current	Price
CF-1	1000 MFD	15 VDC	\$.98
CF-20	2500 MFD	15 VDC	1.95
CF-6	4000 MFD	30 VDC	3.25
CF-19	500 MFD	50 VDC	1.95
CF-18	2000 MFD	50 VDC	3.25
CF-21	1200 MFD	90 VDC	3.25
CF-8	200 MFD	150 VDC	1.69
CF-10	500 MFD	200 VDC	3.25

Mounting clamps for above capacitors. 15c ea.

RECTIFIER TRANSFORMERS

All Primaries 115 VAC 50/60 Cycles

Type No.	Volts	Amps.	Shpg. wt.	Price
XF15-12	15	12	7 lbs.	\$ 3.95
TXF36-2	36	2	6 lbs.	3.95
TXF36-5	36	5	8 lbs.	4.95
TXF36-10	36	10	12 lbs.	7.95
TXF36-15	36	15	20 lbs.	11.95
TXF36-20	36	20	25 lbs.	17.95
NFC18-14	18 VCT	14	10 lbs.	5.95

All TXF Types are Tapped to Deliver 32, 34, 36 volts. XFC Type is Tapped to Deliver 16, 17, 18 Volts Center-tapped.

RECTIFIER CHOKES

Type No.	Hy.	Amps.	DC Res.	Price
HY5A	.028	5	.20	\$ 3.95
HY10	.02	10	.30	9.95
HY10A	.014	10	.04	7.95
HY20A	.007	20	.02	12.95

71-2 Warren St. New York 7, N. Y.
Phone: BEekman 3-7385-6

WHOLESALE ONLY

ELECTRONIC COMPONENTS AIRCRAFT EQUIPMENT HYDRAULICS

RADIO & ELECTRONIC SURPLUS 13933-9 Brush St. Detroit 3, Mich. Phone Townsend 9-3403

FOR SALE—TEST EQUIPMENT

Condition—Excellent The following Hewlett-Packard Equipment:
 —300A Wave Analyzer \$300.00
 —205AG Signal Generator 300.00
 —100A Voltmeter 100.00
 —320A Distortion Analyzer 50.00
 —325B Distortion Meter 275.00
 —GR type 583A Output Meter 50.00
 FS-7640, Electronics 830 W. 42nd St., New York 18, N. Y.

D.C. MICROAMMETERS

0-200 ua 3" sq. G.E. DO 50	\$ 8.00
0-100 ua 3" sq. G.E. DO 50	10.00
0-50 ua 3" sq. G.E. DO 50	12.00

R.F. MILLIAMMETERS

0-115 Ma 3 1/4" Weston 425	\$12.00
0-100 Ma 3 1/4" Weston 425	12.00

PRECISION PORTABLE INSTRUMENTS

Single or multi-range D.C. Microammeters, from 5 ua full scale Thermo-couple Milliammeters, from 1.5 Ma. Thermo-couple voltmeters.

Precision Electrical Instrument Co. 146 Grand Street New York 13, N. Y.

OUTSTANDING VALUES

CATHODE RAY—X-RAY—TRANSMITTING TUBE MANUFACTURING EQUIPMENT

- **HIGH VACUUM MERCURY PUMP** with "McLeod" gauge. Mercury diffusion pump is electrically heated. Pressure switch controls operation of pump. Diffusion pump exhausts into a mechanical rotary vacuum pump. "McLeod" gauge measures vacuum to .5 microns.
- **BOMBARDMENT EQUIPMENT**
A grid controlled rectifier using two metal thyratrons which allow continuous and smooth control of anode current.
- **OVEN CUBICLE** with "Brown" pyrometer controller.
- **HI POT TRANSFORMERS**
GE 78Q342
25KVA 60CY 440-1100/440-2200v.
GE Typer
2KVA 60 Cy 110v-60,000v

BRAND NEW EQUIPMENT

- MN26Y Radio Compass Receiver
- DAB-3 Direction Finder
- TBL-13 Transmitter with Spares
- Walkie Talkies
- BC-325 Transmitter
- RF Tuning Unit for BC-446 Radio Range Transmitter
- SCR-625 PPI Receiver-Indicator Console

ROUND PANEL METERS

- R F
- .5 volts output 50 micro
 - 0-4 RF Amp Weston 2 1/2 4.75
 - 0-5RF Amps Weston 2 1/2 3.95
 - 0-300MA DC Weston 2 1/2 3.75
 - 50-5MA DC Weston 3 1/2 4.25
 - with 50MA shunt
 - 0-50Amp DC Weston 3 1/2 4.95
 - 0-100Amp DC Hoyt 3 1/2 5.00
 - 0-3Volts DC Sun 2 1/2 1.95
 - 0-250Volts DC Simpson 3 1/2 5.95
 - with 2500 volt Multiplier
 - 0-5KV DC 0-10
 - 0-150Volts DC MADC 3 1/2 5.75
 - 10-0+6 DB Weston 2 1/2 4.50

PORTABLE METERS

- 0-10Amps DC Weston 4 1/2 7.50
- 0-3-0-30v DC Weston 2 1/2 17.50
- 0-25Amps DC Weston 4 1/2 29.95
- 0-100Amps DC Weston 2 1/2 269
- with 100 Amp Shunt 24.95
- 0-1.5-6v AC Output Meter Weston 5 1/2 12.00

LABORATORY EQUIPMENT

- **ESTERLINE ANGUS** model AWT-N, twin chart recorder scale 2.5-0-2.5 MA DC. Feeds hourly 3 1/2" x 1 1/2" 3" x 1 1/2" Minute 3/4" x 1 1/2" 3" x 6". Writing door—synchronous clock—chronograph pens on each meter. Complete with pens, filler, ink, charts. Brand new, \$550.00.
- **HARTRON SOUND-ON-FILM RECORDER REPRODUCER**. Model A-30. Immediate play back. No processing of film required with operating accessories. Brand new, \$170.00.
- **LECTURE TYPE GALVANOMETER**. DC galvanoid-ammeter—scale 5-0-5. Complete with shunts, 15" x 14 1/2" x 7 1/2". Cenco #82145. Brand new, \$90.00.

AVAILABLE

- POTENTIOMETERS
- CONDENSERS
- TRANSMITTING MICA
- ROTARY SWITCHES
- Inquiries Will Receive Prompt Attention

CABLE AND WIRE

- ARMOUR**
DR1A-23—MHFA7—FRIA-4
Many other types available
- NEOPRENE**
CO-122 3 conductor #22 each
Conductor Rubber Covered
- PLASTIC—NYLON**
Special #22 Spiral Wound Around Nylon Core Colors—Red, Black-White Plastic Insulation
- COAXIAL**
RG 221v RG-74/v

MAST

- 76 Feet Telescopic Aluminum Mast Fully Collapsed Only 11 feet, 7" dia. At Base Tapers to 3" at Top 175.00

TUBES

2C34	35	2051	75
2X2A	65	7193	30
2X2/879	50	8011	2.40
3C24/24G	50	9001	50
7C4/1203A	40	9002	35
10Y	35	9006	30
15Y	75	C5B	9.75
39/44	25	CEQ72	1.40
45 Spec	35	CK-70	3.50
211	45	CR-72	1.40
713A	80	E-1148	3.00
801A	40	EY-615	40
803	3.25	RKR-72	75
826	45	RK-73	75
869B	23.95	VT-127A	2.00
872A	1.45	CBP1	3.45
1028	30	5CP1	2.75
1029	25	5BP1	4.24

TIME DELAY SWITCHES

- 1 Minute 115v AC 80 cy enc. in waterproof case.New 5.25
- 3 Micro Switches make contact at 40-41-42. Second time delay 110v AC motor.New 4.00
- 30-40 Second Mercury Time Delay Relay. Adelaide.New 6.50
- Thermo Switch 50°F to 300°F 115v AC @ 6A, 230v AC @ 5A breaks contact with increase in temperature. New1.35

TIME DELAY LINE

- 1 Micro Second 15 KVA 400 cy 50 ohm. Brand new.\$14.95

GENERATOR VOLTAGE REGULATOR

- 115 Volt 400 cycle GE GBA 20C New \$19.95

TOGGLE SWITCHES

- DPST 3A-250v w/hardware.25
- DPDT One throw momentary 20 amp 125v AC.New 6.50
- 3PDT 10A 25v AC.75
- DPDT 5A-250v.70

DE-ION LINE STARTER

- DPST 115 v 60 cy 15 amp 1 h.p. Whse. with interlock.New \$4.95

AMERICAN BLOWER AND MOTOR

- 1/2 HP GE motor 115v 1 phase 60 cy. 1725 rpm cw rotation—10 1/2" wide. 12" high intake 8" dia. output 4 1/2" x 4 1/2". Brand new \$24.95

TERMS Minimum order \$5.00—mail orders promptly filled—all prices F.O.B. Boston, Mass. Send M.O. or check. Shipping charges sent C.O.D. 25%, deposit required on all C.O.D. orders.

INQUIRIES FROM DEALERS, SCHOOLS AND INDUSTRIAL FIRMS INVITED

COMET ELECTRONIC SALES CO.
22 WASHINGTON ST. BEACON 2-7863 BRIGHTON 35, MASS.

THE BEST IN ELECTRONIC —SURPLUS—

- BC-610 Transmitters with BC-614 Speech Amplifier, 4 Plug-In Coils and Exciter Units for 10, 20, 40, and 80 meter operation. Output 400 watts A1, 300 watts A3. Operates from 110/130 cycles AC. Used in SCR-299, 399, 499 eqpt. Spares available at extra cost. Condition Excellent to like new. Export Packed. PRICE, EACH\$900.00
- SF-1 Radar Eqpts. 10 Centimeter, Brand NEW with complete spares to insure over 10 years of continuous operation. Includes motor-generator set in each, all wave-guide plumbing, instruction books, etc. 19 cases per set, export packing. PRICE, EACH\$2,500.00
- TCS, Collins Ship Transmitter-Receiver, for 12 V. DC operation, radio telephone and radiotelegraph at 20 & 40 watts, 1.5 to 12.0 mc. Complete with all accessories. Excellent, like new condition. PRICE, EACH\$300.00
- Beachmaster, 250 watt Portable Sound Amplifier Systems, with nine speaker rack, tubes, mike, cables, and spares. Operation from 110 volts, one phase, 60 cycles AC. Excellent and New condition units. PRICE, EACH\$495.00
- PRICE, less case of spares\$395.00
- Western Electric Model HLAS, 500 watt Sound Amplifier Systems, consisting of 40 watt Pre-Amplifier; 500 watt Power Amplifier with built-in power supply, expander-compressor circuit. Internal blower-ventilation, 30 kc erasing oscillator circuit for magnetic tape recording, volume and meter controls; two speaker racks, each with 6-60 watt dynamic horn units. Operation from 115/3/60 AC. New, Unused. Complete with tubes, cables, connectors and instruction manual. EACH\$695.00
- RMCA, Model 8010 I.F. Ship Main Radio Transmitter, 325 to 500 KC. types CA & E. Excellent condition. Less motor generators. PRICE, EACH\$475.00
- RMCA, Model 8019A/H.F. Ship Transmitter, complement to 8010 above, for H.F. transmission A1 and A2, 200 watts output. Excellent Condition. Less tubes and MG (mg with 8010 powers this unit). PRICE, EACH\$400.00
- RMCA, 8003 Emergency Transmitter, 500 KC. 50 watts output with 12/115 V. DC. motor generator set, and battery charging unit. Excellent Condition. Complete with tubes. PRICE, EACH\$275.00
- RMCA, 8007 Lifelab Transmitter-Receiver, 500 KC. for permanent installation. Complete with installed 12 V. Dynamotor. Excellent Condition. PRICE, EACH\$100.00
- RMCA, 8609X Auto Alarm Receivers, 500 KC Automatic SOS (4-second dash actuated) Alarm Unit. Complete with Relay Control Box and warning light. For 110 V. DC operation. Excellent Condition. with tubes. PRICE, EACH\$250.00
- RMCA, 8506B H.F. Receiver, 2 to 23 mc., low-radiation superheterodyne. With tubes. Excellent Condition. PRICE, EACH\$200.00
- RMCA, 8707 Direction Finder. (Int. Freq.) consists of receiver, loop, shaft, rotating wheel. Excellent Condition except shaft housing not available (can be easily improvised). With tubes. PRICE, \$750.00
- Maekay, Model 150-AV, I.F. Ship Transmitter, 325 to 500 KC, A1 and A2 emission. Excellent Condition. PRICE with MG, 115 V. DC. EACH\$350.00
- PRICE without MG, EACH\$275.00
- BC-163 Radio Beacon Eqpnt. 20-40 MC. Converts SCR-508/528/608/628 to directional transmitters and receivers. Ideal for airports for homing application. NEW and complete eqpt. Export packed. PRICE, EACH\$90.00
- SCR-511 "Pogo Stick" Walky-Talky. Portable low-power AM radiotelephone for 2 to 6 mc operation, with 12 plug-in tuning coils containing crystals for crystal control of both receiver and transmitter. Transmitter-Receiver BC-745 of this SCR-511 includes telescopic antenna and "Press-Talk" Switch TE-157 Vibrator Power Supply 2-volt battery (less electrolyte). P-17 mike, ready for immediate operation. PRICE, EACH\$75.00
- 32 Volt DC to AC Rotary Converter, mfd. by Kato. For yachts, workboats, or farm installation. Output 110 V., 60 cycles AC, rated 225 watt but good to 300 watts. All NEW Units. PRICE, EACH\$39.95
- Deck Entrance Insulators, bowl and flange type, 3 1/2" dia. with heavy galvanized metal flange and bell. Top bell 6 1/2" dia. x 1 1/2" brass feed thru rod. Very high voltage insulation. Individually packed in cartons, all NEW, 12 FOR\$18.00
- General Electric Amplidyne M. G. Set, generator type #V-5875677, motor type #73AB58, Navy #CG-21ABU, 115/230 V., 60 cycles, motor rated at 1/2 HP., generator output 250 V. DC at 375 watts. NEW. PRICE, EACH\$60.00
- British Infra-Red Image Converter Tubes. For "Snooperscopes", etc. For infra-red detectors, devices that see in the dark, camera work, laboratories, etc. Six for \$25.00. Discount on larger quantities.
- Hundreds of other items, including: AN/CRT-1A Sonobuoy Transmitters 67.7 mc, excellent condition to new, 40 available; APQ-2 Transmitters, new condition; TCR Control Boxes; 12 V. DC to 110 V. AC Rotary Converters; Transformers of all types; Capacitors; Relays; Insulators; Bowl, Egg, Strain, and Stand-Off in large quantities, etc., etc.

WRITE US YOUR REQUIREMENTS.

All Above Material Subject To Prior Sale.

—TELEMARINE—
COMMUNICATIONS
COMPANY

540 W. 27th ST., N. Y. C.

CABLE: TELEMARINE, NEW YORK

Midget Relays



Guardian 300 ohm SPST 24 VDC ceramic insul 3 amp c o n t . #R106 59¢ ea.

CLARE #BA10050-3 275 ohms SPDT 24VDC Micalox Insul 1 amp cont. #R7369¢ ea.

ALLIED 55837 250 ohms SPST N. O. Double break 15 amp cont. #R10898¢ ea.

SINE-COSINE—SQUARE WAVE POTENTIOMETER



W. E. CO# D169100 for very low freq. sweep circuits. \$9.95 ea.

H-F TIE POST



(Pictured actual size) 4-40 Thread

LOW-LOSS BAKELITE INSULATION \$7.50/C \$60.00/M

Relays Telephone Type

CLARE 2000 ohms 3PST N. O. 1 amp cont. #R19498¢ ea.

AUTOMATIC 1300 ohm SPST N. O. 1 amp cont. #R103 98¢ ea.

TIME DELAY RELAY

Amperite 24V02 24V AC or DC, SPST N. O. 5 amp. cont. 2 sec. delay #R31689¢ ea.

Allied Type BO Relays

55 VAC DPDT. Operates on 12 VDC or 110VAC. Intermit. duty (5 min.). Two units in series for 110VAC for 4PDT oper. #R21\$1.25 ea.

BO-13D35 24VDC SPST NO. Dble Br 230 ohms #R06 98¢ ea.

Antenna Switching Relays

115 VAC DPDT 10 amp cont. manual release latch 200 ohms. Allied\$1.49 ea.

G. E. #37845 50 ohm 12VDC ceramic insulation 10 amp. cont. #R57.\$1.25 ea.

LEACH 1054B, 205 ohms 24 VDC DPST N. O. 10 amp. cont. #R11089¢ ea.

Servo Output XFMRs



PP6L6 to Servo mechanism with 10% feed-back winding. MU metal core \$2.95 ea.

DUAL unit PP6V6 to Servo mechanism with 10% feedback winding and 6SN7 to Servo mechanism. Both in 1 can.\$3.25 ea.

KENYON S13377 XFMR 5V. C.T. 80 Amp #7301 \$11.50 ea.

LARGE STOCKS OF

- AN Connectors
- APC's
- Binding Posts
- Cable
- Capacitors
- Ceramics
- Ceramics
- Chokes
- Circuit Breakers
- Coils
- Controls
- Crystals
- Filters
- Fuses
- Hardware
- Iron Core Slugs
- Knobs
- Potentiometers (sine-cosine)
- Pulse Xfmr's
- Relays
- Resistors
- Servo Xfmr's
- Shock-Mount Sockets
- Sphagetti Switches
- Transformers
- Tubes
- And Others

Write Us Your Needs for Immediate Quote

Over 100,000 Relays in Our Vast Stock

Min. Order \$5.00

Prices Not FOB Our Plant

Universal/general corp.

324 Canal St. New York 13, N. Y. Walker 5-9642

A. C. VOLTMETERS

- 15 Volts, Westinghouse NA-35, 3 1/2" Round flush bakelite case (JAN MR35WO15 ACVV) @ \$3.95
- 40 Volts, Westinghouse NA-33, 2 1/2" Round flush metal case, black scale luminous markings. (These were originally calibrated for 400 cycle use but have been adjusted for 60 cycle) @ \$3.95
- 40 Volts, Westinghouse NA-33, 2 1/2" Round flush metal case, black scale, luminous markings, calibrated for 400 cycles @ \$3.50
- 40 Volts, Weston 517, 2 1/2" Round flush metal case, black scale luminous markings, calibrated for 400 cycles @ \$3.50
- 75 Volts, Weston 517, 2" Round flush metal case ring-clamp type mounting, non-flanged @ \$2.95
- 150 Volts, Weston 517, 2 1/2" Round flush bakelite case (JAN type MR24W150ACVV) @ \$4.50
- 150 Volts, Triplett 332-JP, 3 1/2" Round flush metal case @ \$4.00
- 150 Volts, Triplett 331-JP, 3 1/2" Round flush bakelite case @ \$4.50
- 150/300 Volts, Dual Range, Triplett 331-JP, 3 1/2" Round flush bakelite case with external series res. for 300 volts, scale calibrated 150, double scale indications for 300 volt use @ \$5.50
- 300 Volts, Triplett 232-C, 2 1/2" Round flush metal case @ \$6.00

A. C. AMMETERS

- 10 Amperes, G.E. AO-25, 3" Square flush bakelite, expanded between 4 and 7 amps. Scale calibrated 100 Amps for reading div. scale indicated by 10 @ \$4.95
- 30 Amperes, Triplett 332-JP, 3 1/2" Round flush metal @ \$3.50
- 30 Amperes, Triplett 331-JP, 3 1/2" Round flush bakelite @ \$4.00
- 50 Amperes, Westinghouse NA-35, 3 1/2" Round flush bakelite case 25 to 500 cycles @ \$4.95
- 60/120 Amperes, Dual Range, Burlington 32xC, 3 1/2" Round flush bakelite case, 5 Amp movement external current transformer @ \$7.50
- 75 Amperes, Burlington 32 C, 3 1/2" Round flush bakelite @ \$4.95
- 150 Amperes, Multirange, General Electric AO-22, 3 1/2" Round flush bakelite, 5 Amp movement with external current transformer. This unit can easily be made into a Multirange Ammeter containing any or all of following: 5, 15, 30, 50, 75, 150. Simple wiring diagram furnished with meters or free on request

COST ONLY \$7.50

RADIO FREQUENCY AMMETERS

- 120 Milliamps, Simpson 125, 3 1/2" Round flush bakelite, arbitrary linear scale calib. 0-10, with caption Output Units, complete with external thermocouple @ \$7.50
- 120 Milliamps, Triplett, 2 1/2" Round flush metal case, arbitrary linear sc. calib. 0-100, black face, lum. markings, no caption, complete with external thermocouple @ \$7.00
- 1 Amp, General Electric DW-52, 2 1/2" Round flush metal @ \$3.50
- 1 Amp, General Electric DW-44, 2 1/2" Round flush bakelite case, black scale @ \$2.95
- 1 Amp, Weston 425, 3 1/2" Round flush bakelite case @ \$11.00
- 1.5 Amp, Weston 507, 2 1/2" Round flush metal black scale @ \$3.50
- 1.5 Amp, Westinghouse RT-35, 3" Square flush bakelite @ \$5.50
- 1.5 Amp, General Electric DW-52, 2 1/2" Round flush metal case, black scale @ \$2.95
- 2 Amps, Westinghouse NT-35, 3 1/2" Round flush bakelite case, with external thermocouple @ \$6.50
- 2 Amps, Westinghouse RT-35, 3" Square flush bakelite case @ \$5.50
- 2 Amps, Weston 425, 3 1/2" Round flush bakelite case @ \$8.50
- 2.5 Amps, Simpson 35, 3 1/2" Round flush bakelite @ \$4.95
- 3 Amps, Weston 507, 2 1/2" Round flush bakelite, black scale @ \$3.95
- 3 Amps, Westinghouse NT-35, 3 1/2" Round flush bakelite (JAN type MR35W003FAA) @ \$5.50
- 5 Amps, Westinghouse RT-35, 3" Square flush bakelite @ \$7.50
- 5 Amps, General Electric DO-44, 3 1/2" Round flush bakelite @ \$7.50
- 6 Amps, General Electric DW-44, 2 1/2" Round flush bakelite case, black scale @ \$2.50
- 8 Amps, General Electric DW-44, 2 1/2" Round flush bakelite case, black scale @ \$2.95

ALL ITEMS ARE BRAND NEW-SURPLUS-GUARANTEED. All materials shipped from stock same day as order received, subject to prior sale.

MARITIME SWITCHBOARD
338 Canal St., N. Y. 13, N. Y.
Worth 4-8217

Orders accepted from rated concerns, public institutions and agencies on open account, others please send 25% deposit, balance C.O.D. or check with order. All prices FOB our warehouse, N.Y.C.

ALVARADIO SUPPLY CO.

"BUYS" by the CARLOAD

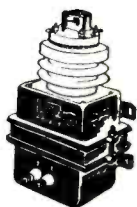

FILAMENT TRANSFORMER
For hi voltage rectifiers. PRI. 115 V., 50/60 cycle. SEC. 5V., C/T @ 10 Amps. 35 KV R.M.S. Test 12 KV D.C. Operating. Uses 872A Tube or other tubes.
Brand New **\$9.95**
872-A Tube\$1.49

WILLARD MIDGET 6V STORAGE BATTERY

\$2.49

3 amp. hour rating. Transparent plastic case, 3-5/8"x1-13/16" x2-3/4" high. Brand new. Use standard electrolyte.

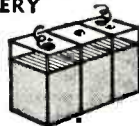

ORDER DIRECT FROM THIS AD
Speedy shipment. Cash with order. 25% deposit on C.O.D. orders. All shipments by truck or R. R. Express collect. California buyers please add state sales tax. All prices subject to prior sale.

A Real Money-Saving Value!

TS 164/AR FREQUENCY METER

This is the Airborne version of BC-221. Comes complete with original calibration book.

\$75.00

Compare this value anywhere!

MG-149H INVERTER

Just a few left to go at this one low price while they last.

\$22.50

A Real Bargain Buy!

T-85/APTS TRANSMITTER

Priced complete with tubes. Used, but in excellent condition.

\$39.50

Manufactured by Galvin!

TS-143/CPM-1 SYNCHROSCOPES

This is an outstanding precision instrument—ideal for any electronic laboratory.

\$175.00

TEST OSCILLATORS

TS-47/APR

\$125.00



Complete with self-contained power supply and power cord. Tunes 40-500 Mc. with usable harmonics up to 3000 Mc. In good used condition. A real precision instrument priced well below its original cost.

SIGNAL GENERATORS

Choice of Three at

\$77 ea.



I-222-A RF. Covers 2 bands—8-15 mc., 150-230 mc. Can use up to third harmonic. Built-in 110 V., 60 cycle power supply. In good condition\$77
I-126, 15-26 mc., 95-130 mc. with built-in power supply. Good condition\$77
I-126, 15-26 mc. 180-235 mc. with built-in power supply. Good condition\$77

WRITE, WIRE OR TELEPHONE **ALVARADIO**

Dept. L-6, 341 S. Vermont Ave., Los Angeles 5, Calif., DUmkirk 8-2211

COMMUNICATION TRANSMITTERS

RCA Model MI-8167 Output 350 W. CW; 250 W. phone 2.0 to 20.0 Mc, 220 V AC input. Net weight 570 lbs. **NEW & COMPLETE.**

OTHER MODELS from 1/2 watt to 1500 watts output, **NEW and complete for ground, aircraft, and shipboard installations.**

RADIO BROADCAST TRANSMITTERS
PORTABLE—"TWT PB-50A"

US Army 50 watt equipment from recordings & console to antenna, 1100-1500 Kcs. In FIVE portable trunks. **NEW & COMPLETE.**

RADIOTELEPHONES

5 WATT, Model JT-52 by Jefferson-Travis, 2 channel, crystal controlled recvr-transmitter, built-in speaker, hand microphone, 6 Volt DC power supply. Freq: 2000-3000 KCS, in compact steel cabinet, complete less xtals. New in original cartons. In dealer quantities.

Also 50 and 75 watt models in stock, 6 channel, **NEW.**

RADAR SEARCH RECEIVER
ARD-2

EQUIPMENT: Consists of the following: 1 ANTENNA-DETECTOR (CMD-66AFH) has variable length antennas (2), diode detector, and silver plated tuning stub with calibrated scale; 1 AMPLIFIER (CMD-50ADC) has three stage pulse amplifier, a trigger circuit, a pulse rate counter circuit and audio amplifier, a visual signal indicator, and a rectifier power supply which is operative on 115 Volts AC, single phase, at 60 to 2400 cycle current, regulated; 1 TEST OSCILLATOR (CMD-60-ABG) has carrier frequency of 400 cycles with selection of four pulse repetition rates. With the above are included all cables with fittings, accessories, and shock mounted rack, a steel chest with complete spare parts and 200% additional tubes and 2 technical manuals. Gross weight 113 pounds. **NEW. Each...\$175.00**

ALSO: **HANDY-TALKIES & WALKIE-TALKIES; Receiver & Transmitter combinations TCS, SCR-508/528, SCR 608/628, AVT/R/A, and others for field use, mobile, aircraft, maritime & ground control installations.**

A **NEW & Complete catalogue** on request.

COMMUNICATION DEVICES CO.

2331 Twelfth Ave. N. Y. 27, N. Y.
Cable: COMMUNIDEV Tel: AD-4-6174. 5

I-208 FM Signal Generators

A limited number of this finest available laboratory instrument is offered subject to prior sale. Specifications are:
Range: 1.0-4.5 mc. & 10-45 mc.
Deviation: 0-5 kc. each side of center frequency in first range and 0.50kc. each side in second band.
Modulation: internal 150, 400, 1000, 2500, or 5000 c.p.s. Provision for external source.
Accuracy: 0.3% with aid of internal 500kc. crystal calibrator.
Output: up to 100,000 microvolts calibrated with internal V.T.V.M., .84 volts uncalibrated.
Termination: 30 ohm line.
Power source: 12 volts dc or 115 volts 60 cycles.

Further details can be obtained by writing

F-S-7718, Electronics
330 W. 42nd St., New York 18, N. Y.

COMPASS

COMMUNICATIONS CO.
393 Greenwich Street,
New York 13, N. Y.

Cable Address: **COMPRADIO**

All merchandise guaranteed
All prices f.o.b. our wise, N. Y. C.



PHONE and CW TRANSMITTERS

WESTERN ELECTRIC radiotelephone 800 watts, new with spares for ship or shore. Same transmitter as used on famous S. S. "Queen Mary," 110-220 volts ac.
100 Watt W. E. radiotelephone w/selective ringer ship or shore, 10-channel, 110 ac oper'n.
25 Watt RCA RT, 32 vdc, 4-channel.
MANY NAVY MODELS, including TDE, TCS, TPK, TRM, TAM, etc. to choose from. Write for info.

SONAR

30 complete, new model NAA, "Herald" underwater anti-submarine units. See "Electr. Eng.," for Feb. 1949 for description
QBG—12 volt, portable, new...\$300.
Also, WEA, QBE, QCO, et al.

RADAR

SN—10 cm. portable, easily set up. Has 2, 5 & 25 mile ranges; 5-in. A-scope. Complete w/full spares...\$685.
SQ—10 cm, 111... Write
Submarine—SJ and SD... Write
Navigation Beacons—Navy Models CXEH and CPN-8 for 115-230 VAC.
Airborne APS3 and APS-4; also new ASB 515 mcs, complete w/ant. & hydraulic controls. Only: \$285.
— Many other types in stock —

THIS MONTH'S SPECIALS* IN:

TUBES (New, Boxed, Guaranteed)

1144G	\$.75	464	\$8.50
1166G	.75	829	4.90
1176G	.75	829A	7.50
6AC7	1.05	860	12.50
6SN7GT	1.75	861	32.50
6V6	.95	872A	1.95
6SL7GT	1.15	715B	6.75
446B	1.75		

MAGNETRONS, KLYSTRONS

2726	\$ 6.50	700 A-C	\$18.50
2727	11.00	706 D-GY	49.00
2461	24.00	707A	12.00
2K25	24.00	728 AY	20.00
4331	95.00	728 GY	24.00
4333	110.00	D161145 (W.E.)	150.00

CAPACITORS (oil-filled)

.01 mfd 500 vdc	\$1.00	10 mfd 600vdc	\$1.00
.1 mfd 600 vdc	2.50	2 mfd 1000vdc	1.25
1.25 mfd 330 vdc	.75	15 mfd 600vdc	3.00
2 mfd 600 vdc	.60	1 mfd 10 kv dc	14.00
4 mfd 600	.85	25 mfd 20 kv dc	25.00

DYNAMOTORS (dc in unless spec'd)

A. 28 @ 1.25 a to 250 @ 60 ma	\$ 3.00
B. 28 @ 7 a to 510 @ 250 ma	5.00
C. 13, 28 @ 12/8 a to 400/500	6.50
D. 14 @ 46 a to 515/1030 and 2/8, 50 ma up	9.50
E. 28 @ 10 a to 300/150/14.5, 10 ma up	10.00
F. 32 @ 13 a to 430/6.3 @ 350/8.0	35.00
G. 13 @ 13 a to 250/300 @ 60/225 ma	15.00

AND MANY OTHERS

COAX CONNECTORS

83 1SP	\$.35	UG 87 U	
83-1A1	.17	(Gold pl w/hood)	1.25
83-R	.35	UG 65 U	6.50
83-1H	.08	UG 56 U	4.75
UG 58 U	.60		

METER MULTIPLIER

High precision resistor, 20 megohms at 20,000 volts with accuracy of 1/2 of 1%. Mfrs. Weston, Sprague. Only...\$24.25

TRANSFORMERS

650 VA—115 V, 60c to 50-55-60-65 V or 350 VA—220 V, 60c to 11.0...\$9.00

TEST EQUIPMENT

3 emf., multipurpose, portable, field and bench test set, model TS-263A/TPS-10. Brand new \$575.
*New only. Some quantities limited.

Do You Use CLAMPS

AN-3057—

3—4—6—8—10—12

Priced From 10¢

David Greenberg

74 Cortlandt St. N. Y. 7, N. Y.
WO 2-3064



MIRROR— front surface aluminized on optical glass 1 3/16" diameter 3/32" thick...\$5.00



PRECISION LEVEL— Inter-ground tube level with 4 adjusting screws. Overall length 1 1/2", diam. 15/32". One end with shoulder 1/2" diam. \$8.85

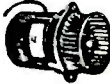

DELCO BLOWER— sirocco type D.C. Flange diameter 3 1/2" blade 3-3/16" RPM @ 12 volts 3400 RPM @ 6 volts 1600...\$3.95



SELENIUM RECTIFIERS— G.E. model 6RS 6FB3 maximum A.C. volts 56 D.C. amps. 0.150...\$1.35



CIRCUIT BREAKER— 10 amp 30 volt D.C. C-H Cat. #8751K4...\$1.10



GLASS VIAL— to use as a permanent level on equipment...\$1.00



Miniature lamp T1 1/4, 3 volt .19 amp. Airplane Indicator, Amb. Ctd.
10 for...\$.85
100 for...\$7.50



Lamp Assembly C203 Genl. 1 Made by Eastman Kodak with Iris Diaphragm 12 volt lamp...each \$1.95

WATTHOUR METER SINGLE PHASE— G.E. type 1-16 two wire 5 amp. 115 volt 60 cycle...\$5.75

SEND FOR FREE BULLETIN

TELEPHONE BEERMAN 3-8623
A. Cottone & COMPANY ELECTRONIC MECHANICAL & OPTICAL COMPONENTS
336-340 CANAL ST., NEW YORK 2, N.Y.
ALL PRICES F.O.B. N. Y. CITY

ELECTRONIC TUBE-MAKING MACHINERY

For manufacturing radio tubes, electronic tubes, cathode-ray tubes, lamps. New and used. Reasonably priced, satisfaction guaranteed.

AMERICAN ELECTRICAL SALES CO.
67 E. 8th St. New York, N. Y.

FOR IMMEDIATE DELIVERY FROM STOCK

ALL TYPES OF FASTENING DEVICES, ETC.

Screws—Nuts—Washers—Tubular Rivets—Eyelets—Lockwashers—Rubber Grommets—Elastic Stop Nuts—Solder Lugs—Peining-Type Turret Lugs—Spaghetti—Banana Jacks & Plugs—Eby Binding Posts—Rivnuts—Misc. Handles, Hinges—Lid Braces—Knobs—Tinnerman & Adel Rubber Lined Cable Clamps—Fiber Washers—Resistor Mounting Boards—Terminal Strips—T. & B. Solderless Lugs—Power Potentiometers—Switches—Wire Wound Resistors—Pilot Light Jewel Assemblies—Springs—Rubber Feet—23 Million Ceramic Beads—and Literally Thousands of other Fasteners & Radio Hardware Items.

FOUR FLOORS SOLIDLY STOCKED

WITH CURRENTLY REQUIRED ELECTRONIC HARDWARE ITEMS FOR DEFENSE CONTRACTS

It will pay you to visit us— or write—or phone your requirements.

LOUIS LANCHER CO.

50M WEST BROADWAY, N. Y. 7
Phone BE 3-8090-1

Gasoline Engine Generators

HOMELITE HRU-28—28.5 Volt DC, 2000 Watts. Used, Tested\$69.50
 HOMELITE 7D28-11—30 Volt DC, 1500 Watts. Used, Tested\$59.50
 AIRCRAFT PORTABLE C-1B—110 Volt DC, 3000 Watts. Used, Tested\$175.00
 HOMELITE PU-6—110 Volt AC, 400 cycle, 1400 Watts and 24 VDC 14.3 A. Unused.....\$195.00
 DELCO 7B12—12 Volt DC, 750 Watts.....\$69.50

Brand New BLOWERS

115 Volt 60 cycle, approx. 100 Cubic Ft. dis. 3 3/4" intake, 2" outlet. Motor size: 3 1/2" x 3", 1595 RPM. Complete with mounting bracket, Gov't surplus. Brand new and boxed.

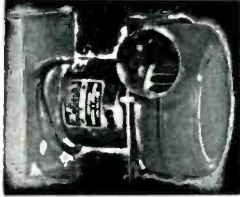

Order No. **\$7.95**
 E-3604

WRITE FOR QUOTATION ON YOUR SMALL MOTOR, DYNAMOTOR, & INVERTER NEEDS!

WHIP ANTENNA EQUIPMENT: MAST BASES—INSULATED

MP-132—1" heavy coil spring, 2" insulator. Overall length: 11 1/2". Weight: 2 3/4 lbs. Price.....\$3.95
 MP-22 Spring action direction of bracket. 4" x 6" mounting. Price\$2.95

MAST SECTIONS FOR ABOVE BASES:

Tubular steel, copper coated, painted, 3 foot sections, screw in type. MS-53 can be used to make any length, with MS-52-51-50-49 for taper. Price, per section50¢
 SECTIONS MS-54—55 Larger than MS-53..... 75¢ ea.
 BAG BG-56 for carrying 5 mast sections.....50¢ ea.

DYNAMOTORS:

INPUT:	OUTPUT:	STOCK NO:	PRICE:
9 V. DC	450 V. 60 MA.	DM-9450	
@ 6 V. DC	275 V. 50 MA.	w/Blower	\$3.95
12 or 24 V. DC	440 V. 200 MA. &		
	220 V. 100 MA.	D-104	9.95
12 V. DC	600 V. 300 MA.	BD-86	7.95
12 V. DC	330 V. 150 MA.	BD-87	5.95
12 V. DC	375 V. 150 MA.	BD-83	6.95
12 V. DC	1000 V. 300 MA.	BD-77	7.95

Address Dept. E • • • All Prices Are F.O.B. Lima, O. • 25% Deposit on C.O.D. Orders

FAIR RADIO SALES

132 S. Main St. LIMA, OHIO

"AN" "K"

3108 WK
 3106 GK
 3102 SK
 3100 NK

Connectors

LARGE QUANTITIES

IN STOCK

What Types Do You REQUIRE?

WRITE—WIRE—PHONE

WILGREEN

74 Cortlandt St. N. Y. 7, N. Y.
 BA-7-4862

GENERATOR:

Output #1—1.5 v. a-c. 10.4 a. 90% P.F. 1200 watt, single phase, 800 cy. @ 2400 RPM.
 Output #2—28.5 v. d-c. 60 a.
 Size: 6 1/2" dia. 13 1/2" O.A. length incl. 7/8" dia. splined shaft 2" long. Flange mounting. Wt. 42 lbs. Rotation counter clockwise viewed from drive end. Generators are self excited. Brand new in original boxes. Mfd. by Bendix. Special Price \$27.50 ea. 2 for \$50.00.

RECTIFIERS

Copper Sulphide, F.W.B. 3.5 v. a-c in. 1.8 v. d-c @ 1 amp out. (Pine for 1.5 v. d-c filaments). New, boxed. \$60 each, 10 for \$5.00, 100 for \$40.00.

TUBES:

Discount 20% on orders over \$50.00

1B22	\$4.25	715B	6.50
1N21	.40	719A	9.50
2J62	37.50	721A	2.75
4B22	2.50	722A	7.50
250TTL	19.50	731B	2.50
1B4	.35	725A	8.50
388A	2.75	730A	10.50
700A	9.25	846	47.50
701A	3.50	872A	1.25
702A	2.75	C5B	7.75
703A	2.75	C6A	8.25
704A	1.00	C6J	4.75
707A	12.50	FG81A	3.75
707B	7.00	WE-	
708A	2.75	203A	8.75
713A	.75	VT9A	
714AY	3.75	(Br.)	12.50
715A	7.50		

SPECIAL: Rectigon, Westinghouse Battery Charger Tube, 6 amp. 65 v. cat. #289414/JAN41B28. New. orig. box. \$1.50 each, 4 for \$5.00.

Immersion heater, Westinghouse, low surface, 3 heat, oil type, 115 v. 200, 400, and 800 watt. 1 1/4" male pipe connection with carrod elements projecting 9". List \$17.20. Our price \$6.50 each, 2 for \$10.00.

NEW!

- low prices
- values
- equipment
- components

Note: All merchandise not designated as new is guaranteed to be in excellent to new condition.

EPCO

1527 E. 7th St.
 Los Angeles 21, Calif.

CAPACITORS: Fast, dual .25 mfd., 600 v. d-c or 125 mfd., 12000 v. d-c. 3 1/2" x 5" x 9 1/2" high including 2 1/2" dual standoff insulators. New. Original packing. 4 per case. \$2.95 each—4 for \$10.00.
 TRANSIST. 115/220 v. 50/60 c., 0-260 v. 2 1/2 amp. cont. 5 amp. max. output. New. Original packing. List \$43.00. \$17.50 each, 2 for \$30.00.

NEW RA-38 RECTIFIERS

115 v., 60 cy. 1 phase input, output 0-15,000 v. d-c @ 500 ma. Write for detailed information.

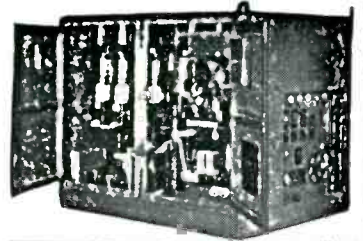

THERMOSTAT SWITCH: Air or immersion—has 1/2" pipe union connection with 3/8" dia. thermal element projecting 6". Temperature adjustable from 250° to 450°F. Switch opens one circuit, closes other on temperature change. Cap. 12.50 watts, 10a, 125 v., 5 a. 2.0 v., 3 a. 460 v., 2 a. 600 v. Mfd. by Persons Model 502 2A. New original box. \$1.95 ea.; 2 for \$3.50.

TEST LEAD CLIPS: Frankel alligator type with barb for checking through insulated wire. New. 1/2kg. of 20 \$1.00; \$4.50/C; \$39.00/M.



Filament Transformer

HIGH VOLTAGE FILAMENT TRANSFORMERS:

Amertran Type W.S. .050 KVA, 50/60 c., 1 phase; 35 KV test, 12 KV d-c operating; see 5 v. c-t @ 10 amps. Has socket that takes 872A, 250T.

371, 5563 etc., rectifiers. Net Wt. 16 lbs. \$12.50 each, 2 for \$22.50, 4 for \$40.00.

LARGE QUANTITIES of RADIO TRANSMITTING TUBES

TYPE	PRICE	PACKING
807	\$1.59	IN CARTONS
805	\$4.75	" "
813	\$7.50	" "
1622	\$1.49	" "
954	\$0.10	IN BULK

SUBSTANTIAL DISCOUNTS ON LARGE ORDERS

All tubes are brand new standard brands. This offer subject to change without notice and prior sale. Terms: 25% deposit with order, balance C.O.D. \$25.00 dollars minimum order.

MANUFACTURERS:

WANT MORE EXPORT SALES? CONTACT: MICHEL LEVIT

Domestic Division: TUBE DEPARTMENT

METROPOLITAN OVERSEAS SUPPLY CORPORATION

1133 Broadway, New York 10, N. Y.

Telephone: CHelsea 3-1105

FM Carrier Current Communication Equipment

BRAND NEW G.E. STOCK
 FREQ. RANGE 70 KC TO 200 KC
 MOBILE and FIXED STATION UNITS

Mobile Receivers 5.7-volt input \$50.00 ea.
 Mobile Transmitters 5.7-volt input power output 25 watts \$100.00 ea.
 Fixed Sta. Receivers 110V/60/1 \$125.00 ea.
 Fixed Sta. Transmitters 110V 50 Watts Out \$175.00 ea.
 Fixed Sta. Console Controls with 5" Speaker (can be used for any type installation) \$20.00 ea.
 Western Electric F-3 Handsets W/Retrax Cord \$8.00 ea.
 Eicor Dynamotors 5.7-v at 22 amp input—450v @ .150 amp out \$15.00
 Eicor Dynamotors 5.7-v at 25 amp input—600-v @ .150 amp output \$18.00

ABOVE MATERIAL ALL BRAND NEW DELIVERY FROM STOCK

Subject to Prior Sale

AIRCRAFT RADIO INDUSTRIES, INC.

274 Madison Ave., New York City
 780 State St., New Haven, Conn.

RADAR EQUIPMENT

APS-3 3cm Search Radar
 APS-4 3cm Search Radar
 SCR-717B 10cm Search Radar
 SO-9 10cm Search Radar
 APR-4 Receivers & Tuning Units
 TS-12 Standing Wave Amplifier
 Test Equipment and Signal Generators for 10 and 3cm

Write for Catalogue

LERU LABORATORIES, INC.

360 Bleecker St., New York 14, N. Y.
 OREGON 5-3525

TAB TUBES TESTED-GUARANTEED THAT'S A BUY Write for Quantity Prices

Table listing various vacuum tube types and their prices, including models like OA2, OA3, OA4, etc., and their corresponding costs.

PRECISION RESISTORS - 2 1/2 Million!

"TAB" Specialists - We Ship Types in Stock 0.1 to 950K ohms, Ea. 35¢; 10 for \$3.29...

Vacuum Precision Hi-Volt Resistors Megohms - 12, 25, 50, 83, 99/1.15/2/3/3.75/1/2% Accy. Ea. \$1; 10/\$7.50

SNOOPERSCOPE INFRARED

Image Converter Tube Hi-Sensitivity, Simplified Design, 2" dia. Willemite Screen-Resolution up to 350 lines/in. Data & Tube.

35MM FILM - Guaranteed Surplus

36Exp. Plus-X 35mm Cart.-ridges 5 for \$1.00 36 Exp. Microfile 35mm Cart.-ridges 5 for \$1.00

BLOWERS - Cool That Tube!

40 CFM 28vacdc & Xfmr to 115vac. \$4.98 70 CFM 115v/400cy. \$4.49

400 Cyt/115V Inpt Xformers

FREED 5500vct, 30 lbs. Csd. \$12.98 A-3140, 3030, 2920, 2810V/350Ma. 4.98

115V/60 cye Inpt Xformers

1400vct/90ma. 6.3v/7A, 5v/3A/1.5A. \$4.98 1000vct/150ma. 300v/1.5A, 6.3v/5A, 5v/3A.

PLATE TRANSFORMERS

7500Vor15000V Dbltr/35ma \$18.95 3000V/10ma. Csd HiVinsul. 4.50 1800V/4ma. H'Sld. HiVins. 3.29

RELAYS-FAMOUS MAKE

CLARE Octal 115VAC/DPNC SPNO \$3.98 CB/Bopper. 7024/200to1200. \$2.98

MODULATION & AUDIO XFMRs

MODUL/240Vatts Peak PP Par807's to PP807's RF/200ohmLoad STANOCOR/USN. 18151. \$6.95

25000 VDC Cndsr - NEW!!

7000 wdc .002 \$1.29 .0075 1.69 15000 wdc .0016 8.98 16000 wdc .05 10.98

MICA XMITTING CNDRS

Sim. Types "F" Mfd Each "I550", "I5", etc. Mfd Each

2500 VDC

.05 \$.39 .008 1.49 1500 VDC .04 .75 .000033 .65 .05 .90 2000 VDC .003 .75 .000082 1.35 .005 .98 .0001 1.89 .008 1.05 .00015 1.89

1500 VDC

.04 .75 .000033 .65 .05 .90 2000 VDC .003 .75 .000082 1.35 .005 .98 .0001 1.89 .008 1.05 .00015 1.89

INDEX TO ADVERTISERS

Ace Engineering & Machine Co.	273
Acheson Colloids Corp.	40
Acme Wire Co.	283
Acro Manufacturing Company	58
Adams and Westlake Company	151
Advance Electric and Relay Co.	281
Advertising Council	217
Aeronautical Communications Equip- ment, Inc.	177
Aerovox Corp.	44
Aircraft Radio Corporation	46
Airpax Products Company	180
Alden Products Co.	227
Allen Co., Inc., L. B.	289
Allied Control Company, Inc.	140
Allied Radio Corp.	196
Allmetal Screw Products Co., Inc.	186
Almo Radio Company	260
Altec Lansing Corporation	259
American Electrical Heater Co.	200
American Lava Corp.	51
American Phenolic Corporation	131
American Screw Company	18
American Smelting & Refining Co.	149
American Television & Radio Co.	278
American Time Products, Inc.	160
Amperex Electronic Corp.	Third Cover
Amperite Company, Inc.	259
Amplex Electronic Corporation	288
Amplifier Corp. of America	271
Antara Products Div., General Aniline & Film Corp.	26, 27
Anti-Corrosive Metal Products Co., Inc.	253
Anton Electronic Laboratories, Inc.	53
Arkwright Finishing Company	232
Arma Corporation	213
Arnold Engineering Company	185
Art-Lloyd Metal Products Corp.	281
Artos Engineering Co.	210
Art Wire & Stamping Company	275
Atlantic India Rubber Works, Inc.	277
Atak Company	263
Audio Fair	275
Automatic Coil Winder & Electrical Equipment Co., Ltd.	228
Automatic Electric Sales Corp.	16
Ballantine Laboratories, Inc.	170
Barker & Williamson, Inc.	247
Barrett Varnish Co.	289
Barry Corporation	62
Bead Chain Manufacturing Co.	255
Bell Telephone Laboratories	181
Bendix Aviation Corporation, Pacific Division	196
Bentley, Harris Mfg. Co.	55
Berkeley Scientific Company	284
Berlant Associates	277
Bird Electronic Corp.	272
Bircher Corporation	273
Blake & Johnson Company	238
Blaw-Knox Co.	144
Bliley Electric Company	194
Boonton Radio Corporation	121
Bowser, Inc.	257
Bracke-Sieb X Ray Co., Inc.	277
Bridgeport Brass Co.	22
Browning Laboratories, Inc.	218
Brush Development Company	25
Burnell and Company	45
Cambridge Thermionic Corp.	270
Capitol Radio Engineering Institute	273
Carborley Company	168
Carborundum Co.	193
Carnegie-Illinois Steel Corp.	173
Centralab, Div. Globe-Union, Inc.	11, 12, 13, 14
Central Paper Co., Inc.	188
Chicago Transformer, Div. of Essex Wire Corp.	222
Cinch Manufacturing Corp.	113
Clare and Co., C. P.	57
Claroast Mfg. Company, Inc.	52
Cleveland Container Company	35
Clippard Instrument Laboratory, Inc.	277
Cohn Corporation, Sigmund	253
Collins Radio Company	54
Communications Accessories Company	258
Condenser Products Company	7
Continental Carbon, Inc.	279
Continental-Diamond Fibre Co.	48, 49
Cornell-Dublier Electric Corp.	139
Corning Glass Works	145
Cornish Wire Company, Inc.	178
Cossor (Canada) Limited	184
Coto-Coll Co., Inc.	174
Crane Packing Company	158
Cross Co., H.	289
Dalmo Victor	257
Dano Electric Company	221
Daven Co.	167
Dial Light Company of America	208
Dietz Design & Manufacturing Company	287
Dollar Company, Robert, The Communication Equipment Division	256
Heintz & Kaufman Division	206
Donnelly Electric & Mfg. Co.	24
Dow Corning Corporation	289
Driver-Harris Company	47
Du Mont Laboratories, Inc., Allen B. 16A.	16B
du Pont de Nemours and Co., Inc., E. I.	207

Eastern Air Devices, Inc.	285
Eastman Kodak Company	123
Cellulose Products Div.	155
Industrial Photographic Div.	208
Edison, Inc., Thomas A.	156
Edo Corporation	21
Etzel-McCullough, Inc.	212, 289
Elster Engineering Company, Inc.	275
Electric Indicator Co.	263
Electrical Industries, Inc.	39
Electrical Reactance Corp.	266, 289
El-Tronics, Inc.	214
Electronic Tube Corporation	138
Electrons, Inc.	281
Electro Tec Corporation	202
Electro-Voice, Inc.	270
Emsco Derrick & Equipment Co.	19
Erie Resistor Corp.	246
Fairchild Camera & Instrument Corp.	219
Fairchild Engine & Airplane Corp.	41
Federal Telecommunication Laboratories, Inc.	175
Federal Telephone & Radio Corp.	289
Federated Purchaser	183
Ferranti Electric, Inc.	263
Fisher-Pierce Company, Inc.	255
Fisher Radio Corp.	277
Freed Radio Corp.	195
Freed Transformer Co., Inc.	253
Garwell Company	246
Garrett Co., Inc., George K.	30, 31, 153, 203
General Electric Company	176
Apparatus Dept.	36, 42, 43, 136, 137, 171
Chemical Dept.	237
Electronics Dept.	221
General Precision Laboratory, Inc.	191
General Radio Company	271
Glenco Corp.	216
Grant Pulley & Hardware Co.	269
Graphite Metallizing Corp.	289
Green Instrument Co.	165
Gries Reproducer Corp.	230
Guardian Electric Mfg. Co.	261
Hardwick, Hndle, Inc.	212
Hathaway Instrument Co.	240
Haydon Company, A. W.	50
Haydon Mfg. Company, Inc.	208
Heath Company, The	179
Helland Research Corporation	248
Hellpot Corporation	215
Hemlinway & Bartlett Mfg. Co.	29
Hermetic Seal Products Company	279
Hewlett-Packard Company	244
Hexacon Electric Company	200
Highland Engineering Co.	23
Hollister Mills, Inc.	272
Holtzer-Cabot, Div. of National Pneu- matic Co., Inc.	15
Houghton Laboratories, Inc.	283
I-T-E Circuit Breaker Company	246
Industrial Condenser Corp.	288
Instrument Resistors Company	4, 5
International Rectifier Corp.	161
International Resistance Co.	263
Ivington Varnish & Insulator Co.	129
Jelliff Manufacturing Corporation, C. O.	265
Jensen Manufacturing Co.	269
Johnson Co., E. F.	248
Jones Div. Howard B. Cinch Mfg. Corp.	180
Jones Electronics Co., M. C.	250
Joy Manufacturing Company	10
Kahle Engineering Co.	289
Karp Metal Products Co., Inc.	225
Katron	37
Kay Electric Company	117
Kenyon Transformer Company, Inc.	20
Kester Solder Company	158
Kinney Manufacturing Company	189
Knights Co., James	283
Kollman Instrument Div., Square D Company	135
Lambda Electronics Corporation	289
Leeds & Northrup Co.	271
Metal Textile Corporation	245, 251
Linde Air Products Co., Unit of Carbide & Carbon Corp.	64, 115
Magnecord, Inc.	201
Mallory and Company, Inc., P. R.	192
Manning, Maxwell & Moore, Inc.	2
Marconi Instruments, Ltd.	184
Marion Electrical Instrument Co.	240
McGraw-Hill Book Co.	274
Measurements Corporation	285
Metal Textile Corporation	34
Mico Instrument Co.	226
Millen Mfg. Co., Inc., James	289
Milo Radio & Electronics Corp.	33
Miniature Precision Bearing, Inc.	148
Minneapolis-Honeywell Regulator Co., Industrial Division	199
Minnesota Mining & Mfg. Co.	162
Mitchell-Rand Insulation Co., Inc.	3
Mosinee Paper Mills Company	9
Multhead & Co., Ltd.	56
Multicore Solders, Ltd.	
Mycalene Tube Socket Corp.	

The NEW
-PRECISION-
SERIES EV-20

VTVM and Multi-Range Test Set
TRUE ZERO-CENTER on ALL VTVM ranges
PLUS Direct Reading High Frequency Scales

48 RANGES TO
1200 Volts*, 2000 Megohms, 12 amperes, + 63DB
*D.C.—VTVM ranges to 12,000 and 30,000 Volts when
used with Series TV Super-High Voltage Test Probe.



- Range Specifications**
- ★ SIX ALL-ZERO CENTER VTVM RANGES: — 1 1/3 Megs. Constant Input Resistance. ± 3, ± 12, ± 30, ± 120, ± 300, ± 1200 volts. Direct Reading to ± 12 KV and ± 30 KV with Series TV Super-High Voltage Test Probe.
 - ★ SIX SELF-CONTAINED OHMMETER-MEGOHMMETER RANGES: 0-2000-200,000 ohms. 0-2-20-200-2000 Megohms.
 - ★ FOUR DIRECT READING HIGH FREQUENCY VTVM RANGES: 0-3-12-30-120 volts. (When used with RF-10A High Frequency Vacuum Tube Probe, Net Price \$14.40. No crystal rectifiers employed.)
 - ★ SIX AC-DC AND OUTPUT VOLTAGE RANGES at 1000 ohms/volt. 0-3-12-30-120-300-1200 volts.
 - ★ EIGHT D.C. CURRENT RANGES: 0-300 microamps. 0-1.2-3-12-30-120-1200 milliamps. 0-12 Amperes.
 - ★ SIX DECIBEL RANGES from — 20 to + 63 DB. Calibrated for 600 ohm, 1 mw., zero DB reference level.

- Important Features**
- ★ VOLTAGE REGULATED — BRIDGE CIRCUIT
 - ★ DIRECT READING, ALL ZERO-CENTER VTVM eliminates frequent and inefficient shifting of test leads.
 - ★ HIGH FREQ. VOLTAGE SCALES — DIRECT READING.
 - ★ DUAL-BALANCED ELECTRONIC BRIDGE OHMMETER-MEGOHMMETER.
 - ★ 4 1/2" RECTANGULAR METER — 200 microamperes, ± 2%. Double-Sapphire, D'Arsonval construction.
 - ★ 1% Film type, Metallized and Wire-Wound resistors.
 - ★ Heavy gauge, loured steel case with plastic handle. Etched, anodized, aluminum panel.

Net Selling Price \$6475

Complete with coaxial Circuit Isolating Test Probe, Shielded Ohmmeter Test Cable, Standard Test Leads, Ohmmeter battery. Case dimensions — 10 1/2" x 6 1/4" x 5".

Also ask to see the "Precision" Series EV-10, DeLuxe VTVM—Megohmmeter with extra-large 7" meter. 59 Self-contained ranges to 6000 volts and 70 DB. on display at leading radio parts distributors.

Write for latest catalogue.

Precision Apparatus Co., Inc.
92-27 HORACE HARDING BLVD.
ELMHURST 10, N. Y.

Export: 458 B'way, N.Y.C., U.S.A. Cables: MORHANEX
In Canada: Atlas Radio Corp. Ltd., Toronto, Ontario



INDEX

TO THE MOST SKILLFULLY
MADE COIL COMPONENTS
IN THE INDUSTRY



Width Control Coils

Whether your coil requirements include one of the super-fine quality coils shown above, or one of the various coil types listed in the index below, you can feel certain that U. S. Electronics' advanced engineering and progressive production methods can make them—to your specifications—with greater precision and economy than virtually any other coil manufacturer on the market today.

- | | |
|------------------------------------|---------------------|
| Cathode Trap Coils | Heater Check Coils |
| I. F. Transformers | Video Peaking Coils |
| Width Control Coils | R. F. Coils |
| Horizontal Linearity Control Coils | |
| Horizontal Oscillator Coils | |
| Oscillator and Solenoid Coils | |
| Sound Discrimination Transformers | |
| Sound I. F. Transformers | |
| Picture I. F. Transformers | |

Write us for engineering samples
to your specifications.



united states electronics
CORPORATION
LYNDHURST NEW JERSEY

National Company, Inc.	244	Westinghouse Electric Corp.	143, 157
National Research Corporation	211	Weston Electrical Instrument Corp.	32
National Vulcanized Fibre Co.	150	White Dental Mfg. Company, S.S.	184, 231
Newark Electric Company	275	Whitehead Stamping Company	279
New Hampshire Ball Bearings, Inc.	269	Wicox Electric Company	164
New Hermes	261	Wiley & Sons, Inc., John	133
New York Transformer Co., Inc.	198		
North American Aviation, Inc.	180	Zophar Mills, Inc.	204
Northern Radio Co., Inc.	279		
Nothelfer Winding Laboratories	284		
Ohmite Manufacturing Co.	32A, 32B		
O'Neil-Irwin Mfg. Co.	276		
Paper Machinery & Research, Inc.	267		
Paramount Paper Tube Corp.	270		
Par-Metal Products Corp.	192		
Patton-MacGuyver Co.	188		
Permodux Corp.	263		
Pfaustlich Chemical Company	286		
Philo Plastics Corporation	212		
Phillips & Hiss Co., Inc.	283		
Plastics & Electronics Co.	289		
Polarad Electronics Corporation	224		
Polytechnic Research and Development Company, Inc.	17		
Potter Instrument Co., Inc.	239		
Precision Apparatus Co., Inc.	319		
Precision Paper Tube Co.	212		
Presto Recording Corporation	59		
Progressive Mfg. Co.	220		
Pyramid Electric Co.	60		
Pyroferic Co.	214		
Quaker City Gear Works, Inc.	265		
Radio Corp. of America	127, 205, 254, Back Cover		
Radio Frequency Laboratories, Inc.	204		
Radio Materials Corporation	229		
Radio Receiver Company, Inc.	233		
Radio Shack Corp.	288		
Railway Express Company, Air Express Division	236		
Rawson Electrical Instrument Co.	267		
Raytheon Manufacturing Co.	125		
R.C.A. Service Co., Inc.	259		
Remler Company, Ltd.	287		
Resistance Products Co.	216		
Rex Rheostat Co.	289		
Robinson Aviation, Inc.	299		
Rogan Brothers	265		
Rome Cable Corporation	249		
Sanborn Company	166		
Sanamo Electric Company	235		
Scientific Electric, Div. of "S" Corrugated Quenched Gap Co.	274		
Seovill Manufacturing Co.	250		
Servo Corporation of America	275		
Shalleross Mfg. Co.	146		
Shure Brothers, Inc.	151		
Sigma Instruments, Inc.	63		
Simpson Electric Company	172		
Societe Industrielle ALFA	280		
Sola Electric Company	6		
Sorensen and Company, Inc.	38		
Speer Carbon Company	214		
Specialty Battery Company	188		
Spincraft, Inc.	278		
Sprague Electric Company	119		
Stackpole Carbon Co.	28		
Stainless, Inc.	248		
Standard Piezo Company	257		
Standard Pressed Steel Co.	281		
Standard Transformer Corporation	267		
Stayer Company, Incorporated	273		
Steiner Mfg. Co., Wm.	200		
Stevens Mfg. Co., Inc., Geo.	252		
Stevens Manufacturing Company, Inc.	182		
Steward Manufacturing Co., D. M.	267		
Stoddard Aircraft Radio Co.	152		
Struthers-Dunn, Inc.	190		
Superior Tube Company	147, 194		
Suprenant Mfg. Co.	231		
Sylvania Electric Products, Inc.	61, 131		
Tektronix, Inc.	280		
Telechron, Inc.	197		
Telequip Radio Company	271		
Teletronics Laboratory, Inc.	289		
Tel-Instrument Co., Inc.	216, 276		
Tenney Engineering, Inc.	264		
Titelflex, Inc.	269		
Transradio, Ltd.	196		
Triplett Electrical Instrument Co.	8		
Turner Company	223		
Union Carbide & Carbon Corp.			
The Linde Air Products Co. Unit	271		
Union Electric Products Co.	273		
United States Electronics	320		
United States Steel Corp.	173		
United Transformer Co.	Second Cover		
Universal Winding Company	169		
Varflex Corporation	209		
Veeder-Root, Inc.	163		
Victoreen Instrument Company	268		
Vulcan Electric Company	265		
Waldes Kohinoor, Inc.	141		
Ward Leonard Electric Company	142		
Waterman Products Co., Inc.	282		
Webster Electric Co.	192		
Weller Electric Corp.	286		
Western Lithograph Company	187		

PROFESSIONAL SERVICE 290

SEARCHLIGHT SECTION (Classified Advertising)

EMPLOYMENT	
Positions Vacant	291, 292, 293, 294
Selling Opportunities Offered	293
Positions Wanted	291
Selling Opportunities Wanted	291
Employment Services	291
SPECIAL SERVICES	
Contract Work	291
EQUIPMENT	
(Used or Surplus New)	
For Sale	291, 295-318
WANTED	
Equipment	291
Advance Transformer Co.	291
Airborne Instrument Lab., Inc.	293
Aircraft Radio Industries, Inc.	317
Alvarado	315
Alexander, F.	291
American Electrical Sales Co.	316
Applied Science Corp. of Princeton, The	292
Arkay Co., The	291
Arrow Sales, Inc.	309
Bendix Aviation Corp.—Bendix Radio Division	293
Berkeley Scientific Co.	294
Blan	313
C & H Sales Co.	312
Chance Vought Aircraft Div., United Aircraft Corp.	294
Columbia Electronics Ltd.	312
Comet Electronic Sales Co.	314
Communication Devices Co.	316
Communications Equipment Co.	295, 296, 297
Compass Communications Co.	316
Consolidated Vultee Aircraft Corp.	294
Cornell Aeronautical Laboratory, Inc.	293
Cottone & Co., A.	316
Electro Impulse Laboratory	303
Electronic Engineering Co. of Calif.	294
Electronic Surplus Brokers	291
Electroncraft, Inc.	300
Empire Electronics	291
EPCO	317
Fair Radio Sales	317
Franklin Institute	292
Ganchar Co., Louis	316
Goodyear Aircraft Corp.	292
Green, Gould	291
Greenberg, David	316
Hallcrafters Co., The	294
Hughes Aircraft Co.	293
Instrument Associates	298, 299
Lectronic Research Laboratories	306
Legri S. Co., Inc.	311
Leru Laboratories, Inc.	317
Liberty Electronics, Inc.	312
Life Electronic Sales	310
Maritime Switchboard	315
Martin Co., The Glenn L.	294
Maxson Corp., The W. L.	294
Metropolitan Overseas Supply Corp.	317
Minneapolis-Honeywell Regulator Co.	292
Mogull Co., Inc., Alexander	308
Monmouth Radio Laboratories	310
National Instrument Co.	310
National Union Research Division	292
Opad-Green Co.	313
Ostby & Barton Co.	291
Peak Electronics Co.	307
Precision Electrical Instrument Co.	313
Radio & Electronic Surplus	313
Radio Corp. of America—R.C.A. Victor Div.	292
Radio Ham Shack, Inc.	302
Raytheon Manufacturing Co.	291
Reliance Merchandizing Co.	304
Sagal Co., Leo	313
Servo-Tek Products Co., Inc.	305
Southwestern Industrial Electronic Co.	293
Tab	318
Telenarine Communications Co.	314
Tomsett Associates	291
Universal General Corp.	314
Victor-Bernard Industries	291
Wells Sales, Inc.	301
Westinghouse Electric Corp.	294
Westinghouse Electric Corp.—Electronics & X-Ray Div.	292
Wilgreen	317
Wilson, G. C.	291

This Index is published as a convenience to the readers. Every care is taken to make it accurate, but ELECTRONICS assumes no responsibility for errors or omissions.

NEW MORE EFFICIENT LOWER PRICED

WIDE BAND Television Operation to 220 MC with

AMPEREX

TYPE 9904/5923 — WATER COOLED

TYPE 9904-R/5924 — AIR COOLED

TUBES



14 MC Band
Width at 220 MC

Outputs of 5.7 KW

Filaments of
HORNIATED TUNGSTEN

Non-Emitting Grid

Disc Type Grid Seal for
MINIMIZED INDUCTANCE

OPTIMUM Design
Minimum Capacitance at
Maximum Transconductance

Grid and Filament
Connectors Available

Proven Life

**CONSERVATIVELY
RATED**

re-tube
with
AMPEREX

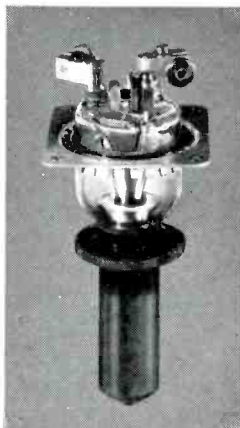

TYPE 9904/5923

TYPICAL TELEVISION OPERATION

GROUNDED GRID

(Two tubes in Push-Pull)

Frequency (MC)	220
Band Width (MC)	14
D.C. Plate Voltage	4000
D.C. Grid Voltage	
Synchronizing Level	—200
Black Level	—290
White Level	—550
Peak RF Grid Voltage (Grid to Grid)	1000
D.C. Plate Current (AMP) Synchronizing Level	2.5
Black Level	1.76
D.C. Grid Current (MA) Synchronizing Level	400
Black Level	160
Driving Power (approx. watts)	1000
Power Output (KW) Synchronizing Level	5+0.7
Black Level	3

Data Sheets and Charts Available . . .



AMPEREX ELECTRONIC CORP.

25 WASHINGTON STREET, BROOKLYN 1, NEW YORK
In Canada and Newfoundland: Rogers Majestic Limited
11-19 Brentcliffe Road, Leaside, Toronto, Ontario, Canada

12 REASONS WHY...

it pays equipment manufacturers to deal with RCA



1. RCA Application Engineering Service—

Twelve field engineering specialists devote their time *exclusively* to the design problems of equipment manufacturers. They're ready to pitch in and help you at any time.



2. RCA Application Engineering Laboratories—

RCA maintains application laboratories at Harrison, Lancaster, and Chicago. The services of these laboratories are at the disposal of all RCA tube and component customers



3. RCA Circuit Investigations—

RCA carries on independent research in circuit design for the exclusive benefit of its tube and component customers. Engineering reports are provided as a free service



4. RCA Tube and Component Development—

RCA works years ahead in tube and component design—anticipates future requirements. That's why you get the types of tubes and components you want *when* you want them.



5. RCA Engineering Literature—

RCA technical bulletins and data, covering the specifications and operating conditions of RCA tubes and components, are the most authoritative and comprehensive in the field

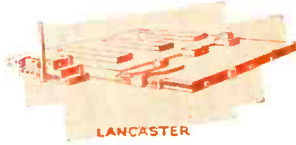

6. RCA Manufacturing Facilities—

RCA tubes and components are manufactured in modern plants equipped largely with RCA-designed, precision machinery—your assurance of uniform, dependable quality tubes and components



7. RCA Quality Control—

Quality controls begin with the raw material and are followed through in every successive step of manufacture and assembly. That's why RCA tubes and components are consistently reliable.



8. RCA Sales and Customers' Service—

A staff of seasoned sales representatives are within convenient reach. They're available *when* you want them. In addition, a staff at the Home Office devotes its time *exclusively* to expediting your orders.



9. RCA District Offices—

RCA maintains three conveniently located district offices in Harrison, Chicago, and Los Angeles to serve equipment manufacturers. You can get prompt service from the office nearest you.



10. RCA Distribution—

RCA maintains bulk tube and component stocks in three warehouses strategically located in Jersey City, Chicago, and Los Angeles for quick service



11. RCA Pricing—

Mass-production techniques and the RCA "Preferred Type Plan" have consistently operated to reduce manufacturing costs—which mean lower prices to you.

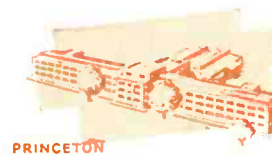

12. RCA Engineering Leadership—

The vast resources of experience and ability that account for RCA's engineering leadership in tubes and components, are of direct benefit to RCA customers... a final reason why it pays to deal with RCA.

Sales and Product Directory

1. **General sales information** or requests for application engineering assistance on receiving and television picture tubes, communications and industrial tubes, power tube fittings, electronic components, and test and measuring equipment:

Equipment Sales Field Representatives at the RCA Sales Office nearest you:

City and State	Street Address	Telephone No.
Harrison, N. J.	415 S. 5th St.	Harrison 6-8000
Chicago 11, Ill.	589 E. Illinois St.	Whitehall 4-2900
Los Angeles 13, Calif.	420 S. San Pedro St.	Madison 9-3671

2. **Inquiries relative to technical bulletins:** Commercial Engineering, RCA,

415 South 5th Street, Harrison, N. J.

3. **Orders and inquiries on orders:** Tubes: RCA warehouse serving you:

Jersey City Warehouse, RCA 34 Exchange Place Jersey City 2, N. J. Phone: Bergen 4-2100	Chicago Warehouse, RCA 589 E. Illinois St. Chicago 11, Ill. Phone: Whitehall 4-2900
Los Angeles Warehouse, RCA, 420 S. San Pedro St. Los Angeles 13, Calif. Phone: Madison 9-3671	



RADIO CORPORATION of AMERICA
ELECTRON TUBES AND COMPONENTS
HARRISON, N. J.